

ABoT II

ANKARA ARKEOLOJİ MÜZESİNDE BULUNAN
BOĞAZKÖY TABLETLERİ
II

BOĞAZKÖY TABLETS IN THE
ARCHAEOLOGICAL MUSEUM OF ANKARA
II

RUKİYE AKDOĞAN

Katalog ve Dizin / Catalog and Index

OĞUZ SOYSAL

Library of Congress Control Number: 2010941268

ISBN-10: 1-885923-81-3

ISBN-13: 978-1-885923-81-3

The Oriental Institute, Chicago

© 2011 by The University of Chicago. All rights reserved.

Published 2011. Printed in the United States of America.

THE ORIENTAL INSTITUTE OF THE UNIVERSITY OF CHICAGO
CHICAGO HITTITE DICTIONARY SUPPLEMENTS
NUMBER 1

Series Editors

Leslie Schramer

and

Thomas G. Urban

with the assistance of

Natalie Whiting

Series Editors' Acknowledgments

Foy Scalf, Oya Topçuoğlu, and Felicia Whitcomb assisted in the production of this volume.

Cover Illustration

Nr. 125. AnAr 11407 önyüz / obverse

Printed by Edwards Brothers, Ann Arbor, Michigan

The paper used in this publication meets the minimum requirements of American National Standard for Information Services — Permanence of Paper for Printed Library Materials, ANSI Z39.48-1984.

TABLE OF CONTENTS

| | |
|--|------|
| ÖNSÖZ..... | vi |
| FOREWORD | vii |
| SUNUŞ..... | viii |
| INTRODUCTION | ix |
| LIST OF ABBREVIATIONS | x |
| GUIDE TO TURKISH-ENGLISH TERMS | xii |
| KATALOG | 1 |
| Tarihsel Metinler (CTH 1–216 “Textes Historiques”) | 2 |
| İdarî ve Teknik Metinler (CTH 221–287 “Textes Administratifs et Techniques”) | 2 |
| Okul Metinleri (CTH 299–316 “Textes Scolaires”) | 2 |
| Mitoloji (CTH 321–370 “Mythologie”) | 2 |
| İlâhî ve Dualar (CTH 371–389 “Hymnes et Prières”) | 3 |
| Ritualler (CTH 390–500 “Rituels”) | 3 |
| Din Hayatı ile İlgili İdarî Metinler (CTH 501–530 “Administration Religieuse”) | 6 |
| Kehanet Metinleri (CTH 531–590 “Divination”) | 7 |
| Bayram ve İbadet Metinleri (CTH 591–720 “Fêtes et Cultes”) | 7 |
| Yabancı Diller (CTH 725–791 “Langues Étrangères”) | 11 |
| Sumer-Akkad Edebî Eserleri (CTH 792–819 “Littérature Suméro-Akkadienne”) | 12 |
| Değişik Konular, Dili ve Türü Saptanamayan Metinler (CTH 820–833 “Varia”) | 13 |
| CATALOG..... | 19 |
| Historical Texts (CTH 1–216 “Textes Historiques”) | 20 |
| Administrative and Technical Texts (CTH 221–287 “Textes Administratifs et Techniques”) | 20 |
| Lexical Texts (CTH 299–316 “Textes Scolaires”) | 20 |
| Mythological Texts (CTH 321–370 “Mythologie”) | 20 |
| Hymns and Prayers (CTH 371–389 “Hymnes et Prières”) | 21 |
| Rituals (CTH 390–500 “Rituels”) | 21 |
| Cult Administration and Inventory Texts (CTH 501–530 “Administration Religieuse”) | 24 |
| Divination Texts (CTH 531–590 “Divination”) | 25 |
| Festival Texts (CTH 591–720 “Fêtes et Cultes”) | 25 |
| Texts in Other Languages (CTH 725–791 “Langues Étrangères”) | 30 |
| Sumerian and Akkadian Texts (CTH 792–819 “Littérature Suméro-Akkadienne”) | 31 |
| Varia and Texts of Unknown Type (CTH 820–833 “Varia”) | 31 |
| ÖZEL İSİMLER DİZİNİ / INDEX OF PROPER NAMES..... | 37 |
| Tanrı İsimleri / Divine Names..... | 37 |
| Şahıs İsimleri / Personal Names..... | 39 |
| Yer İsimleri / Geographical Names..... | 39 |
| Dağ İsimleri / Mountain Names | 41 |
| Pınar İsmi / Spring Name..... | 41 |
| KONKORDANZ / CONCORDANCE | 43 |
| LEVHALAR / PLATES 1–64 | |

ÖNSÖZ

Kavimler Kapısı Anadolu'nun dünya tarihindeki rolü, her geçen gün yeni buluntuların gün ışığına çıkması ile daha da artmaktadır. Anadolu medeniyetlerinin tarih sırası ile görülebileceği Ankara Anadolu Medeniyetleri Müzesi'nde, geçmişimizi aydınlatan çok sayıda eser korunmaktadır. Bunların içinde bulunan çivi yazılı tabletlerin, binlerce yıllık geçmişi günümüze yazılı olarak aktarmaları dolayısıyla ayrı öneme sahip oldukları muhakkaktır.

Hititler, Anadolu'da ilk siyasi birliği kuran kavimdir. Hititler, çivi yazısını kullanarak Hititçe, Akadca, Hattice, Hurrice, Luvice, Palaca gibi dillerde tabletler yazmışlardır. Bu belgeler, o dönemin tarihi, ekonomisi, sosyal hayatı, hukuku, edebiyatı, dini vs. hakkında bilgi vermektedir.

Hititler dönemine ait olan bu tabletlerin kopyasını yapan Rukiye Akdoğan ve katalog kısmını hazırlayan Oğuz Soysal başlıca kaynak kitaplardan biri olarak kullanılacak olan, "*Ankara Arkeoloji Müzesinde Bulunan Boğazköy Tabletleri II*" adlı eseri Hitit Bilimine kazandırmışlardır. Kendilerine bu başarılı çalışmalarından dolayı tebrik, takdir ve teşekkürlerimi sunuyorum.

Hikmet Denizli
Anadolu Medeniyetleri Müzesi Müdürü
30 Mayıs 2008
Ankara

FOREWORD

The role of Anatolia, the “Gate of the Nations,” in world history is being augmented by the new finds that steadily come to light each day. In the Ankara Anadolu Medeniyetleri Müzesi where one can chronologically view the civilizations of Anatolia, a large number of archaeological finds are preserved that shed light on our past. Among these, without any doubt, the cuneiform tablets possess a very special importance since they transmit the past in written form over the millennia to the present days.

The Hittites are the first people to have established political unity in Anatolia. Using the cuneiform script they composed texts in Hittite, Akkadian, Hattian, Hurrian, Luwian, and Palaic. These documents yield information about the history, economy, social life, law, literature, and religion of that period.

Rukiye Akdoğan, who has prepared the cuneiform copies of these tablets from the Hittite period, and Oğuz Soysal, who has supplied a catalog, have now delivered the *Ankara Arkeoloji Müzesinde Bulunan Boğazköy Tabletleri II*, a would-be reference book, to the field of Hittitology. Let me express my congratulations, appreciation, and thanks to both of them for their successful work.

Hikmet Denizli
The Director
Museum of the Anatolian Civilizations
May 30, 2008
Ankara

SUNUŞ

Anadolu Medeniyetleri Müzesi Tablet Arşivi'nde korunan Hitit tabletlerinin çoğunluğunu, kazılardan elde edilen tabletler oluşturmaktadır. Bunun yanı sıra arşivde, satın alma veya hibe yolu ile kazandırılan tabletler de yer almaktadır.

Boğazköy'de bulunmuş olup, Alacahöyük kazı heyetine bağışlanan ve oradan da Ankara Arkeoloji Müzesi'ne devredilmiş olan Hitit tabletlerinin neşre değer olanları 1948 yılında, Kemal Balkan tarafından “(A)nkara Arkeoloji Müzesinde Bulunan (Bo)ğazköy (T)abletleri” adı altında yayınlanmıştı. ABoT serisinde toplam 65 adet tabletin kopyası bulunmaktadır.

Müze kayıtlarında satın alma veya hibe yolu ile müzeye kazandırılan en eski tabletin yılı 1932 olarak görülüyor. Daha sonra 1937, 1940, 1941, 1942, 1944 ve sonraki yıllarda da zaman zaman müzeye, çeşitli yerlerden satın alma veya hibe yolu ile tabletler gelmeye devam etmiştir. Bunların önemli bir kısmının geliş yeri envanter defterine Boğazköy olarak kaydedilmiştir; beş adet parçanın geliş yeri ise Kuşsaray (Çorum) olarak kaydedilmiştir; az bir kısmının geliş yerinde soru işareti bulunmaktadır. Ayrıca AnAr 10753 nolu tablet parçasının geliş yerinde, “Emirbaş Köyü” (ancak il adı bulunmamaktadır) ibaresi yer almaktadır.

Yayınlanmamış tabletlerin kopyasını yapmaya karar verdiğimde kitabın adı da hazırды: ABoT II. Eskiden “Ankara Arkeoloji Müzesi” olan müzenin adı, şimdi “Anadolu Medeniyetleri Müzesi” olarak değişmiştir. Fakat günümüzde de hâlâ literatürde veya adres kullanımında “Ankara Arkeoloji Müzesi” kullanılmaktadır; bu durumda ikinci cildin adının birinci cildin devamı olması açısından “Ankara Arkeoloji Müzesinde Bulunan Boğazköy Tabletleri II” şeklinde verilmesinin daha uygun olacağı düşünüldü ve bu isimde karar kılındı.

AnAr numaralı 390 tablet parçasının ilk önce transkripsiyonları, daha sonra kopyaları, yaklaşık altı sene süren çalışmanın sonucunda tarafımdan yapıldı. ABoT II cildinde ise, 389 tablet parçasının kopyası yer almaktadır. Çünkü, AnAr 10285 nolu tablet parçasının, yazılı yüzeyinin çok dökülmüş olmasından dolayı kopyasının yapılmasına gerek görülmemiş, onun yerine burada fotoğrafı verilmiştir. “Ankara Arkeoloji Müzesinde Bulunan Boğazköy Tabletleri” adı ile literatürde yer alan bu tabletlerin, kazılardan elde edilen tabletlerden ayrılması amacıyla, envanter numaraları “(An)kara (Ar)keoloji”nin kısaltması olan “AnAr” şeklinde kullanılmaktadır.

390 adet AnAr tabletinin transkripsiyonlarından oluşan kitap tarafımdan yayınlandı: Hethitische Texte in Transkription: Ankara Arkeoloji Müzesinde Bulunan Boğazköy Tabletleri II (ABoT 2), Dredner Beiträge zur Hethitologie 32, Herausgegeben von Johann Tischler, Wiesbaden 2010.

ABoT II'nin hazırlanması sırasında her türlü desteğinden dolayı, 25.08.2008 tarihinde ne yazık ki beklenmedik bir anda aramızdan ayrılan Müze Müdürü Sayın Hikmet Denizli'ye sonsuz teşekkürler. Müdür Yardımcıları Sayın Emel Yurttagül'e ve Sayın Nihal Tırpan'a da teşekkürlerimi sunuyorum.

Bu cildin yayınlanmasını sağlayan Sayın Prof. Dr. Gil Stein, Sayın Prof. Dr. Theo van den Hout ve Sayın Thomas Urban ve çalışma arkadaşlarına çok teşekkür ediyorum.

Tabletlerin kopyalanması işinde profesyonel olan Sayın Christel Rüster'ten teknik destek alarak bu işe başladım. İlerleyen safhalarda, Sayın Prof. Dr. Gernot Wilhelm'den de destek gördüm. Her ikisine de bundan dolayı içtenlikle teşekkür ediyorum.

Ayrıca müze laboratuvarında, tablet parçalarının temizlenmesini büyük bir titizlikle yapan Sayın Cengiz Özduygulu'ya ve Sayın Sinan Asılkazancı'ya teşekkür ediyorum. Bu cildin hazırlanması sırasında bana büyük destek olan aileme teşekkürlerimi sunuyorum.

Rukiye Akdoğan
26 Şubat 2011
Ankara

INTRODUCTION

The majority of Hittite cuneiform documents deposited in the tablet archive of the Anadolu Medeniyetleri Müzesi are finds from excavations. In addition to these, some tablets were also acquired by purchase and donation.

Some Hittite tablets unearthed at Boğazköy were donated to the excavation team of Alacahöyük and then handed over to the Ankara Arkeoloji Müzesi. In 1948 Kemal Balkan published the best preserved of these tablets in a volume with the title *(A)nkara Arkeoloji Müzesinde Bulunan (Bo)ğazköy (T)abletleri*. In this publication, known by the abbreviation ABoT, sixty-five fragments were given in cuneiform copies.

According to the inventory records of the museum the earliest accession date of those purchased or donated tablets appears as 1932. Later, in 1937, 1940, 1941, 1942, 1944, and also in the following years tablets from different sources have occasionally been brought to the museum through purchase or donation. The inventory records show that the origin of a large group of these fragments is Boğazköy; five pieces came from Kuşsaray (Çorum); and a few have only a question mark in regard to their origin. Furthermore, the fragment with the siglum AnAr 10753 is marked as coming from “Emirbaş Köyü,” however, without naming the province.

When I decided to prepare the copies of the unpublished tablets, the title of the work was already available: ABoT II. The former name of the museum, Ankara Arkeoloji Müzesi, has in the meantime changed to Anadolu Medeniyetleri Müzesi. However, the designation Ankara Arkeoloji Müzesi is still current in the scholarly literature and also in the mailing address of the museum. Therefore, the present edition has been entitled *Ankara Arkeoloji Müzesinde Bulunan Boğazköy Tabletleri II* in order to remain consonant with the title of the first volume of this series.

After nearly six years of labor I finished the transliterations and copies of 390 fragments with the siglum AnAr. In this volume, cuneiform copies of 389 fragments are present and, since the surface of AnAr 10285 (Text no. 140) is abraded and unreadable, a photo of the tablet is given here instead. The fragments published in the volumes entitled *Ankara Arkeoloji Müzesinde Bulunan Boğazköy Tabletleri* are tagged with the siglum “AnAr,” which is the abbreviation for (An)kara (Ar)keoloji, to differentiate them from those tablets found in the course of the regular excavations.

The book that contains the transliterations of 390 AnAr tablets is published by me: *Hethitische Texte in Transkription: Ankara Arkeoloji Müzesinde Bulunan Boğazköy Tabletleri II (ABoT 2)*, *Dredner Beiträge zur Hethitologie 32*, Herausgegeben von Johann Tischler, Wiesbaden 2010.

I am deeply indebted to the director of the museum, Mr. Hikmet Denizli, who sadly and unexpectedly passed away on August 25, 2008, for his enormous support and encouragement during the preparation of ABoT II. I would like to thank also the deputy directors of the museum Mrs. Emel Yurttagül and Mrs. Nihal Tırpan.

I am very grateful to Prof. Dr. Gil Stein, Prof. Dr. Theo van den Hout, and Mr. Thomas Urban and his team who made the publication of this book possible.

I started this project with the technical support of Mrs. Christel Rüster who is a distinguished authority in copying tablets. Later on, Prof. Dr. Gernot Wilhelm also supported me in this regard. My sincere thanks go to both of them.

Finally, I want to express my thanks to Mr. Cengiz Özduygulu and Mr. Sinan Asilkazancı in the museum laboratory who conducted a careful cleaning of the fragments, and to my family who greatly supported me during the preparation of this volume.

Rukiye Akdoğan
February 26, 2011
Ankara

LIST OF ABBREVIATIONS

| | |
|-----------------------------------|---|
| ABoT | Kemal, Balkan. <i>Ankara Arkeoloji Müzesinde bulunan Boğazköy Tabletleri: Boğazköy-Tafeln im archäologischen Museum zu Ankara</i> . Eski Eserler ve Müzeler Genel Müdürlüğü yayınlarından 3/3. İstanbul: Millî Eğitim Basımevi, 1948 |
| Akdoğan, <i>AMMY</i> 2005 | Akdoğan, Rukiye. “Boğazköy Tabletlerinde İlk Kez Belgelenenler İle Birlikte Bazı Şehir İsimleri.” <i>Anadolu Medeniyetleri Müzesi Yıllığı</i> (2006): 197–206, 216–20 |
| Akdoğan, <i>AMMY</i> 2006 | Akdoğan, Rukiye. “Bayram Törenine Ait Çivi Yazılı Hititçe Bir Tablet Parçası.” <i>Anadolu Medeniyetleri Müzesi Yıllığı</i> (2007): 163–77 |
| Akdoğan, DBH 32 | Akdoğan, Rukiye. <i>Hethitische Texte in Transkription: Ankara Arkeoloji Müzesinde Bulunan Boğazköy Tabletleri II (ABoT 2)</i> . Dresdner Beiträge zur Hethitologie, 1619–0874, 32. Wiesbaden: Harrassowitz Verlag, 2010 |
| Akdoğan, <i>SMEA</i> 49 | Akdoğan, Rukiye. “Gurparanzah Destanına Birleşen Yeni Bir Tablet Parçası.” <i>Studi Micenei ed Egeo-Anatolici</i> 49 (2007). VI Congresso Internazionale di Ittitologia Roma, 5–9 Settembre 2005, Parte I: 1–20 |
| Akdoğan-Soysal, <i>AMMY</i> 2002 | Akdoğan, Rukiye, and Oğuz Soysal. “Yayınlanmamış Boğazköy AnAr Fragmanlarından Değişik İçerikli Metinler.” <i>Anadolu Medeniyetleri Müzesi Yıllığı</i> (2003): 172–85 |
| Akdoğan-Wilhelm, <i>AMMY</i> 2001 | Akdoğan, Rukiye, and Gernot Wilhelm. “Ankara Anadolu Medeniyetleri Müzesi’nde Bulunan Hititçe ve Hurrice Yazılmış 4 Çivi Yazılı Tablet.” <i>Anadolu Medeniyetleri Müzesi Yıllığı</i> (2002): 238–47 |
| Akdoğan-Wilhelm, <i>ZA</i> 93 | Akdoğan, Rukiye, and Gernot Wilhelm. “Hethitische und hurritische Keilschrifttafeln aus dem Besitz des Museums für Anatolische Kulturen in Ankara.” <i>Zeitschrift für Assyriologie und Vorderasiatische Archäologie</i> 93 (2003): 214–30 |
| AnAr | Ankara Arkeoloji Müzesi Tabletleri |
| B. Dinçol, <i>SMEA</i> 49 | Dinçol, Belkıs. “Ein mittelhethitischer Brief.” <i>Studi Micenei ed Egeo-Anatolici</i> 49 (2007). VI Congresso Internazionale di Ittitologia Roma, 5–9 Settembre 2005, Parte I: 235–45 |
| Bo | Inventory numbers of Boğazköy tablets excavated 1906–1912 |
| CTH | Laroche, Emmanuel. <i>Catalogue des textes hittites</i> . Second edition. Paris: Klincksieck, 1971 |
| CTH Premier supplément | Laroche, Emmanuel. “Catalogue des textes Hittites: Premier supplément.” <i>Revue hittite et asiatique</i> 30 (1972): 84–127 |
| Edel, <i>ÄHK</i> | Edel, Elmar. <i>Die ägyptisch-hethitische Korrespondenz aus Boghazköi in babylonischer und hethitischer Sprache</i> . 2 volumes. Abhandlungen der Rheinisch-Westfälischen Akademie der Wissenschaften 77. Opladen: Westdeutscher Verlag, 1994 |
| FsKořak | Groddek, Detlev, and Marina Zorman. <i>Tabularia Hethaeorum – Hethitologische Beiträge: Silvin Kořak zum 65. Geburtstag</i> . Dresdner Beiträge zur Hethitologie, 1619–0874, 25 Wiesbaden: Harrassowitz, 2007 |
| FsWilhelm | Fincke, Jeanette C. <i>Festschrift für Gernot Wilhelm anlässlich seines 65. Geburtstages am 28. Januar 2010</i> . Dresden: Islet, 2009 |
| Groddek, <i>AoF</i> 25 | Groddek, Detlev. “Fragmenta Hethitica dispersa V/VI.” <i>Altorientalische Forschungen</i> 25 (1998): 227–46 |
| HT | <i>Hittite Texts in the Cuneiform Character from Tablets in the British Museum</i> . London: The British Museum, 1920 |

- IBoT 1 Bozkurt, Hatice, and Hans G. Güterbock *İstanbul Arkeoloji Müzelerinde Bulunan Boğazköy Tabletlerinden Seçme Metinler – Boğazköy-Tafeln im Archäologischen Museum zu İstanbul*. İstanbul: Maarif Matbaası, 1944
- IBoT 2 Bozkurt, Hatice; Muazzez Çiğ; and H. G. Güterbock. *İstanbul Arkeoloji Müzelerinde Bulunan Boğazköy Tabletleri II. – Boğazköy Tablets in the Archaeological Museums of İstanbul II*. İstanbul: Millî Eğitim Basımevi, 1947
- IBoT 3 Çiğ, Muazzez, and Hatice Kızılyay (Bozkurt). *İstanbul Arkeoloji Müzelerinde Bulunan Boğazköy Tabletleri III. – Boğazköy Tablets in the Archaeological Museums of İstanbul III*. İstanbul: Maarif Matbaası, 1954
- IBoT 4 Eren, Mustafa. *İstanbul Arkeoloji Müzelerinde Bulunan Boğazköy Tabletleri IV - Boğazköy Tablets in the Archaeological Museums of İstanbul IV*. Türk Tarih Kurumu yayınları. VI. dizi. sa. 27. Ankara: Türk Tarih Kurumu Basımevi, 1988
- KBo *Keilschrifttexte aus Boghazköi* (vols. 1–22 are a subseries of WVDOG). Leipzig, Berlin. 1921–
- Konkordanz* Koşak, Silvin. *Konkordanz der hethitischen Keilschrifttafeln*. 5 volumes. Hethitologie Portal Mainz, Materialien, 1862–202X. Wiesbaden: Harrassowitz, 2005
- Koşay, “Kuşsaray” Koşay, Hamit Z. “Kuşsaray (Çorum) Sondajı.” *Türk Arkeoloji Dergisi* 15/1 (1966): 89–97
- KUB *Keilschrifturkunden aus Boghazköi*. Berlin: Akademie-Verlag, 1921–
- Kümmel, StBoT 3 Kümmel, Hans M. *Ersatzrituale für den hethitischen König*. Studien zu den Boğazköy-Texten 3. Wiesbaden: Otto Harrassowitz, 1967
- Laroche, *GLH* 1 Laroche, Emmanuel. *Glossaire de la langue Hourrite: Première partie (A–L)*. *Revue hittite et asiatique* 34 (1976). Special issue
- Laroche, *GLH* 2 Laroche, Emmanuel, *Glossaire de la langue Hourrite: Deuxième partie (M–Z, Index)*. *Revue hittite et asiatique* 35 (1977). Special issue
- Neu-Otten, *IF* 77 Neu, Erich, and Heinrich Otten. “Hethitsch “Mann,” “Mannheit.” *Indogermanische Forschungen* 77 (1972): 181–90
- Riemschneider, DBH 12 Riemschneider, Kaspar K. *Die akkadischen und hethitischen Omentexte aus Boğazköy*. Dresdner Beiträge zur Hethitologie, 1619–0874, 12. Dresden: Technische Universität, 2004
- Riemschneider, StBoT 9 Riemschneider, Kaspar K. *Babylonische Geburtsomina in hethitischer Übersetzung*. Studien zu den Boğazköy-Texten 9. Wiesbaden: Otto Harrassowitz, 1970
- Salvini-Wegner, ChS I/6 Salvini, Mirjo, and Ilse Wegner. *Die mythologischen Texte*. I. Abteilung, Die Texte aus Boğazköy 1126–7313, 6; Corpus der hurritischen Sprachdenkmäler, I. Abteilung, Texte aus Boğazköy, 6. Rome: CNR, Istituto di studi sulle civiltà dell’Egeo e del Vicino Oriente, 2004
- Soysal, *HWHT* Soysal, Oğuz. *Hattischer Wortschatz in hethitischer Textüberlieferung*. Handbuch der Orientalistik, Erste Abteilung, Nahe und der Mittlere Osten 74. Leiden: Brill, 2004
- Soysal, *JCS* 50 Soysal, Oğuz. “A Forgotten Hittite Fragment of the ‘KILAM’ Festival.” (1998): 59–65
- Trémouille, ChS I/8 Trémouille, Marie-Claude. *Texte verschiedenen Inhalts*. I. Abteilung, Die Texte aus Boğazköy, 8. Rome: CNR, Istituto di studi sulle civiltà dell’Egeo e del Vicino Oriente, 2005
- VS Vorderasiatische Schriftdenkmäler der Staatlichen Museen zu Berlin
- WVDOG Wissenschaftliche Veröffentlichungen der Deutschen Orient-Gesellschaft

GUIDE TO TURKISH-ENGLISH TERMS

| Turkish | English |
|---------------|----------------|
| alt kenar | lower edge |
| arkayüz (ay.) | reverse (rev.) |
| kenar | edge |
| levha (lev.) | plate |
| önyüz (öy.) | obverse (obv.) |
| sağ kenar | right edge |
| sağ sütun | right column |
| satır (st.) | line |
| sol kenar | left edge |
| sol sütun | left column |
| sütun (sü.) | column |
| üst kenar | upper edge |
| yazısız | uninscribed |

KATALOG

1948 yılında Kemal Balkan tarafından hazırlanan “Ankara Arkeoloji Müzesinde Bulunan Boğazköy Tabletleri (ABoT)” çivi yazılı metin yayınına burada sunulan ikinci cilt (ABoT II) ile devam edilmektedir. Ankara Anadolu Medeniyetleri Müzesi’ne satın alma, hediye ve yüzey buluntusu olarak ulaşan ve “AnAr” envanter numarası taşıyan Hitit tabletlerinden iyi durumda ve içerikçe önemli olanları yukarıda bahsedilen ABoT yayını ile bilim dünyasına kazandırılmış, diğer fragmanlar ise zamanında yayına değer bulunmamıştır. Sonraları, ABoT serisine devam edilmediği için, çoğunlukla kullanılabilir durumdaki bu tür tablet parçaları uzun yıllardan beri müzede beklemekteydi.

Meslektaşım Rukiye Akdoğan, yayınlanmaya değer dörtüye yakın AnAr fragmanının kopyalarını yapıp bunları ABoT II olarak bilim dünyasına sunmaya karar verdiğinde, eser kataloğunun hazırlanması konusunda işbirliği yapmamız gündeme geldi. Diğer benzeri yayınlar ABoT ve IBoT I–IV’deki çivi yazılı kopyalar her ne kadar yine Türk araştırmacılar (K. Balkan, M. Çığ, H. Kızılyay ve M. Eren) tarafından yapılsa da, özellikle kataloglarının hazırlanmasında yabancı Hititologlar’ın (H. G. Güterbock ve H. A. Hoffner) katkı ve yardımlarına gerek duyulmuştu. Buna karşılık, ABoT II bir Ankara - Chicago ortak çalışması sonucunda bütünüyle Türk araştırmacıları tarafından hazırlanan bir çivi yazılı yayın olma özelliğini taşımaktadır.

Fragmanların genellikle çok küçük boyutlarda olması, metin türlerinin saptanması ve CTH numaralarının verilmesinde zorluk oluşturmuştur. Yine de, yaklaşık iki yıla yakın yoğun bir çalışma sonucu ve Chicago Hittite Dictionary Project’e ait Hititçe kelime fişleri arşivinin de kullanılması ile bir hayli duplikat saptanmıştır. Bu tür metinlerin, bilinen kompozisyonlara küçük de olsa içerikçe katkı sağlayacağı kanaatindeyiz.

Burada kopyası verilen 389 adet tabletle, müzede yayınlanmaya değer başka AnAr fragmanı hemen hemen kalmamıştır. ABoT II’de kopyaları bulunmayan beş AnAr metni hakkında ise şu açıklamalar yararlı olacaktır:

- 1) AnAr 8655 (CTH 209). *Koşak, Konkordanz*’da CTH 832 vasfıyla anılan bu fragman aslında ABoT 64 olarak yayınlanmıştır, ancak oradaki envanter numarası Al/D 164 (Alaca Höyük) şeklinde verilmektedir.
- 2) AnAr 10285 (ABoT II 140). Kopyası yapılamayacak kadar aşınmış olduğundan, burada fotoğrafının verilmesiyle yetinilmiştir (lev. 27).
- 3) AnAr 10590 (CTH 188). Orta Hititçe bu mektup, yakın zamanda B. Dinçol tarafından SMEA 49, 235–245’de incelenmiş, ve orada tabletin fotoğrafı ile çivi yazılı kopyası da verilmiştir.
- 4) AnAr 10605 (CTH 540.I.4). Doğum ominası. K. K. Riemschneider tarafından StBoT 9, 9 n. 1’de incelenmiş ve Textbeilage II’de de kopyası verilmiştir. Ayrıca krş. Riemschneider, DBH 12, 159.
- 5) AnAr 10753 (CTH 540.II.6). Doğum ominası. Daha E. Laroche, CTH Premier supplément’de Nr. 540 altına alınmıştır. K. K. Riemschneider tarafından StBoT 9, 39 vdd. incelenmiş ve Textbeilage II’de de kopyası verilmiştir. Ayrıca krş. Riemschneider, DBH 12, 159. Müze envanter kayıtlarında tabletin geliş yeri olarak Emirbaş Köyü belirtilmektedir.

Bu kitabın baskıya hazırlanışı sırasında, ABoT II metin transkripsiyonları Rukiye Akdoğan tarafından ayrı olarak DBH 32’de yayınlanmıştır. Orada sonradan bulunan bazı yeni joinler —ki teknik nedenlerle burada dikkate alınamamıştır— ve kullanılan değişik transkripsiyon metni nedeniyle, ABoT II çiviyazısı yayınına göre ufak metin genişlemeleri ve özel isimlerde de okunuş farklılıkları oluşmuştur.

ABoT II katalog çalışmaları sırasında, The Oriental Institute’deki Hititçe kelime fişleri arşivinden yararlanmama olanak veren Hittite Dictionary Project’e, ve 2007 yılında sağladığı ek bir ödenek ile iki hafta kadar Ankara’daki çalışmalarımı sürdürmemde yardımcı olan The Oriental Institute’ye teşekkürü bir borç bilirim. İngilizce bölümleri okuyup düzeltmeler yapan Chicago’dan meslektaşım Richard H. Beal’e, ve katalog ayrıntıları ile ilgili bazı yararlı tekliflerde bulunan Gary Beckman’a (Ann Arbor) bu nazik yardımlarından dolayı müteşekkirim.

Oğuz Soysal
10 Şubat 2011
Chicago

Katalog

| Tablet | Levha | Tanımlama |
|---|-------|--|
| Tarihsel Metinler (CTH 1–216 “Textes Historiques”) | | |
| Nr. 1 | 1 | AnAr 12194 (CTH 51.I.C). 4,0 × 2,4 cm. Akkadça Šattiwaza Antlaşması; CTH 51.I.C nüshasına aittir ve öy. 45–55. satırlar KBo 1.1 öy. 43–51’e duplikattır; Akdoğan, <i>AMMY</i> 2005, 200–02. |
| Nr. 2 | 1 | AnAr 4220 ı (CTH 53.E). 2,2 × 3,7 cm. Akkadça Tette Antlaşması; KBo 28.98 ile indirek join ve öy. 2’–6’. satırlar KBo 1.4 II 6–11’e duplikattır. |
| Nr. 3 | 1 | AnAr 11621 a (CTH 71.C). 4,8 × 3,9 cm. “ ^{MUNUS} AMA.DINGIR- <i>LIM</i> Meselesi”; 2’–10’. satırlar KBo 4.8 II 17’–22’ ve III 1–3’e duplikattır. |
| Nr. 4 | 1 | AnAr 11386 (CTH 186 ?). 3,7 × 5,0 cm. 3. satırda [LUGAL [?] KUR] <i>Kar-ga-miš</i> anılır. Metin içerikçe, bir mektup olan KBo 18.48 ay.’e benzemektedir; krş. orada LUGAL ^{KUR} <i>Kargamiš</i> ve BAL- <i>nu-</i> ay. 9’–10’, 13’. |
| Nr. 5 | 1 | AnAr 8916 (CTH 212 ya da 275). 7,0 × 4,8 cm. Özellikle <i>ištamaš- ... UL tekkušnu-</i> “duymak ancak belli etmemek” (öy. 5’–6’) kullanımı dolayısıyla antlaşma veya protokol olabilir. |
| Nr. 6 | 1 | AnAr 14932 (CTH 216). 2,6 × 2,6 cm. Akkadça bir antlaşma fragmanı. ^{LÚ.MEŠ} DAM.GÀR ŠA KUR [<i>Hatti</i>] (st. 6’) kullanımı KBo 1.4 II 2’yi (CTH 53.A) anımsatmaktadır. |

İdarî ve Teknik Metinler (CTH 221–287 “Textes Administratifs et Techniques”)

| | | |
|--------|---|---|
| Nr. 7 | 2 | AnAr 11401 (CTH 238 ?). 7,9 × 5,3 cm. Şehir isimleri listesi. |
| Nr. 8 | 2 | AnAr 9722 (CTH 239). 4,2 × 4,3 cm. Arazi metni. |
| Nr. 9 | 2 | AnAr 12928 (CTH 242). 5,4 × 5,4 cm. Cam imalat tarifi. Metin için bkz. Akdoğan-Wilhelm, <i>AMMY</i> 2001, 242–43; ve ZA 93, 220–22. |
| Nr. 10 | 2 | AnAr 12131 d (CTH 275 ?). 5,9 × 3,5 cm. Herhalde enstrüksiyon; 6’. satırdaki <i>ħalziaši</i> ifadesi için krş. KUB 26.12 III 23. |
| Nr. 11 | 2 | AnAr 14921 (CTH 275 ?). 4,5 × 5,1 cm. Enstrüksiyon ? |
| Nr. 12 | 3 | AnAr 9469 (CTH 276). 5,5 × 6,1 cm. Katalog tablet. |
| Nr. 13 | 3 | AnAr 9134 (CTH 287). 5,6 × 4,7 cm. Hippoloji metni; I [?] 4’ [<i>IŠTU É LÚKUŠ₇p</i>] <i>arā uwadanzi</i> ve I [?] 7’ [... <i>gip</i>] <i>eššar arnuanzi</i> . Metin Orta Hitit yazısı karakteri göstermektedir. |

Okul Metinleri (CTH 299–316 “Textes Scolaires”)

| | | |
|--------|---|---|
| Nr. 14 | 3 | AnAr 15162 (CTH 309). 5,5 × 2,2 cm. Bir vokabular metnin Sumerce kısmı. |
| Nr. 15 | 3 | AnAr 21630 (CTH 309). 4,8 × 3,9 cm. Bir vokabular metnin Hititçe kısmı. |

Mitoloji (CTH 321–370 “Mythologie”)

| | | |
|--------|---|---|
| Nr. 16 | 3 | AnAr 80-1-74 (CTH 335 ?). 4,2 × 4,4 cm. Telipinu Efsanesi’ndeki (CTH 324) tanrıyı sakinleştirme işlemlerini hatırlatıyor; bkz. st. 8’: [^d <i>Te-l</i>] <i>i-pí-n[u]</i> . |
| Nr. 17 | 4 | AnAr 96-6-76 (CTH 348.27.B). 2,6 × 3,0 cm. Hedammu Efsanesi. “Kuşsaray” tabletlerinden olup (diğerleri ise ABoT II 143, 388–90’dur; genel olarak bkz. Nr. 143 altına) H. G. Güterbock tarafından “Çorum 1” ismiyle ve KBo 26.109 numarası altında transkripsiyonu verilmiştir (krş. KBo 26 p. VII). Anılan fragman, KBo 26.79 ile duplikattır; Groddek, <i>AoF</i> 25, 231 vd. (Nr. 44). Bu tür Hurri kökenli bir efsane metninin Boğazköy dışında ele geçmesi ilginç bir durum olarak beliriyor. |
| Nr. 18 | 4 | AnAr 12165 (CTH 361.II.). 4,9 × 6,6 cm. Hurrice Keşşi Hikayesi. |

Katalog

| Tablet | Levha | Tanımlama |
|--------|-------|---|
| Nr. 19 | 4 | AnAr 12164+ (CTH 362.A.1). 3,6 × 9,6 cm. Gurparanzağ Efsanesi. KUB 36.67 III 12' vdd. ile direkt join olmaktadır. Metin için bkz. Akdoğan, <i>SMEA</i> 49, 1–20. |
| Nr. 20 | 4 | AnAr 10869 (CTH 370). 4,5 × 5,7 cm. Hurri ² miliyösünden mitolojik bir metin; öy. 2'–7'. satırlar Fırtına Tanrısı ve İstar'ın anıldığı konuşmaları içermektedir. Bu iki tanrının beraber anılmaları konusunda krş. KUB 33.92 IV 12'–14', KUB 33.113 I 16'–22' (Ullikummi Şarkısı). |

İlâhi ve Dualar (CTH 371–389 “Hymnes et Prières”)

| | | |
|--------|---|---|
| Nr. 21 | 4 | AnAr 11621c (CTH 376.II.K). 4,0 × 2,8 cm. II. Murşili'nin Arinna şehri Güneş Tanrıçası'na yönelik duası; 1'–8'. satırlar KUB 24.3 III 11'–18'e duplikattır. |
| Nr. 22 | 4 | AnAr 11398 (CTH 378.II.D). 3,7 × 3,3 cm. II. Murşili'nin ikinci veba duası; 2'–8'. satırlar KUB 14.11 III 17'–23'e duplikattır. |
| Nr. 23 | 5 | AnAr 12177 (CTH 378.?). 3,8 × 3,7 cm. II. Murşili veba dualarından; 2 ² sayılı tablet kolofonunu da içeren fragmanın bu metin grubu içindeki kesin yeri şimdilik belli değildir. |

Ritualler (CTH 390–500 “Rituels”)

| | | |
|--------|---|--|
| Nr. 24 | 5 | AnAr 10591 (CTH 400). 6,2 × 6,2 cm. “Iriya Rituali”; öy. 6'–11'. satırlar KUB 39.104 IV 1'–6'ya duplikattır. |
| Nr. 25 | 5 | AnAr 12183 (CTH 402). 3,2 × 4,0 cm. “Malli Rituali”; 1'–6'. satırlar KUB 24.9 II 7'–14'e duplikattır. |
| Nr. 26 | 5 | AnAr 14915 (CTH 404.5.II.A). 3,0 × 7,4 cm. AnAr 14915 ile Bo 2738 (= KUB 58.79) aynı tablete aittirler, ancak aralarında direkt bir bağlantı yoktur. |
| Nr. 27 | 6 | AnAr 12131 b (CTH 412 ?). 7,3 × 4,5 cm. Ritual / büyü seslenişleri; Zuwi Rituali'ne benzer. Öy. 14' vdd. sayılan zararlı şeyler KBo 24.51 ay. ² 5'–7' ve KBo 24.52:7'dekileri hatırlatmaktadır. |
| Nr. 28 | 6 | AnAr 11613 a (CTH 430 ya da 470). 5,7 × 3,3 cm. Yerin Güneş Tanrıçasına ritual / dua, ya da bir doğum rituali; krş. KBo 17.60 ay. |
| Nr. 29 | 6 | AnAr 11246 a (CTH 446). 5,0 × 3,8 cm. Ay. ² 1'–11'. satırlar KUB 41.8 II 29'–37'ye paralel gitmektedir. |
| Nr. 30 | 7 | AnAr 21626 + KBo 10.45 (CTH 446.B). 6,1 × 6,9 cm. Metin çalışması Akdoğan-Wilhelm, <i>AMMY</i> 2001, 238–42 ve ZA 93, 214–20. AnAr 21626 + KBo 10.45 IV 37 vdd. ile paralel KBo 53.34 ve diğerleri için bkz. J. L. Miller, KBo 53, s. V (nr. 34 altı). |
| Nr. 31 | 7 | AnAr 11503 a+d (CTH 448). 3,8 × 4,0 cm. 1'–5'. satırlar KUB 60.161 II 7'–10'a paralel gitmektedir; ayrıca krş. KUB 17.18 II 26' vdd. |
| Nr. 32 | 7 | AnAr 14966 (CTH 449 ya da 790). 4,3 × 2,2 cm. Öy. II ² 2'–7'. satırlar KUB 58.88 II ¹ 4'–11'+ KUB 38.22 ay. 5'–8'e duplikattır. |
| Nr. 33 | 7 | AnAr 8926 (CTH 450 ?). 3,8 × 2,6 cm. Krş. KUB 39.8 + KBo 34.58 II 28' vdd., KBo 25.184 II 18 vdd. |
| Nr. 34 | 7 | AnAr 4220 m (CTH 470 ?). 3,0 × 2,3 cm. 4'–5'. satırlar için krş. KUB 7.60 II 13, 15 (CTH 423). |
| Nr. 35 | 7 | AnAr 4220 o + s (CTH 470). 4,1 × 4,1 cm. Ritual ve mitoloji ? |
| Nr. 36 | 7 | AnAr 6993 (CTH 470 ?). 2,7 × 2,1 cm. St. 5 ^o : <i>ŠI-PAT</i> . |
| Nr. 37 | 8 | AnAr 8357 (CTH 470). 4,8 × 2,5 cm. St. 6': [pé]-e-da-an-z[i]. |
| Nr. 38 | 8 | AnAr 9146 (CTH 470 ?). 3,5 × 1,9 cm. St. 3'de <i>himma</i> - kelimesi yer alıyor ise metin bir ritual olabilir. |
| Nr. 39 | 8 | AnAr 10308 (CTH 470 ?). 8,1 × 7,6 cm. Ay. 4' ve 13': <i>ni-ni-ik</i> ? Krş. KUB 59.26 IV 7'. |
| Nr. 40 | 8 | AnAr 10312 (CTH 470 ?). 5,5 × 5,5 cm. Ay. 3' ve 8': <i>DUMU-an-na-aš hu-i-pa-at-ta-an</i> ; krş. KUB 12.58+ II 35': <i>DUMU-la-an-na-aš hu-i-pa-ia-ta-an</i> . |

Katalog

| Tablet | Levha | Tanımlama |
|--------|-------|---|
| Nr. 41 | 8 | AnAr 10320 (CTH 470). 3,2 × 4,1 cm. 5'. satırda [<i>idalu</i>] ^š GISKIM-iš “[köt]ü belirti”den bahseder; krş. KBo 13.101 I 27’-31’ ve ay. 19’-20’ (CTH 435.2). |
| Nr. 42 | 9 | AnAr 10589 (CTH 470). 6,5 × 5,0 cm. Kötü dillere karşı ritual / büyü. |
| Nr. 43 | 9 | AnAr 10594 (CTH 470). 3,2 × 5,2 cm. Bir ritualin eşya listesini(?) vermektedir; 4’. satırdaki <i>šuppiyahh</i> - için bkz. yine bir liste içeren KBo 43.176 ay. 2’ vdd., 6’. |
| Nr. 44 | 9 | AnAr 10602 (CTH 470). 3,1 × 3,8 cm. St. 3’: [EN].SÍSKUR- <i>m</i> [a]; 5’: [<i>i</i>]- <i>ja-at-ta</i> -[<i>ri</i>]. |
| Nr. 45 | 9 | AnAr 10868 (CTH 470). 6,5 × 3,8 cm. 6’-15’. satırlar KBo 24.10 öy. ² I 3’-11’e duplikattır. |
| Nr. 46 | 9 | AnAr 11498 (CTH 470). 7,2 × 5,5 cm. Öy. ² 4’: <i>ha-ri-ja-az</i> -[<i>zi</i>]. |
| Nr. 47 | 10 | AnAr 11501 (CTH 470). 4,0 × 2,7 cm. |
| Nr. 48 | 10 | AnAr 11503 e (CTH 470 ?). 2,4 × 3,2 cm. St. 3’: PA Š[E]; 4’: <i>ša-mi-ši-ja-nu-z</i> [<i>i</i>]; 5’: [I]Š- ¹ TU ¹ KAŠ <i>šu-un-n</i> [<i>i-ja</i> ² - <i>az</i> ² - <i>zi</i>]. |
| Nr. 49 | 10 | AnAr 11503 g (CTH 470). 2,3 × 1,8 cm. 3’-4’. satırlar için krş. KUB 43.60 I 21-22 (CTH 457.6). |
| Nr. 50 | 10 | AnAr 11620 b (CTH 470). 3,7 × 1,1 cm. St. 4’: <i>iš-h</i> [<i>i-ja</i> ² -...]. |
| Nr. 51 | 10 | AnAr 12171 (CTH 470). 7,0 × 6,1 cm. Öy. 10. satırdaki 2 ² /3 ² -ŠU 9 GÍŠGAG GÍŠMA.NU KUB 35.142 ay. ² IV 21’i (CTH 772.4) anımsatıyor. |
| Nr. 52 | 10 | AnAr 14916 (CTH 470). 4,2 × 4,0 cm. Kötülüklerin mıhlanması (yani pasivize edilmesi) ile ilgili majik ritual; 6’-7’. satırlarda kralın ordusu ve düşmanın [ordusu ²] anılmaktadır. |
| Nr. 53 | 11 | AnAr 14989 (CTH 470). 1,7 × 2,0 cm. Kötülük ve büyüye karşı ritual ? |
| Nr. 54 | 11 | AnAr 21813 (CTH 470 ?). 2,4 × 1,6 cm. |
| Nr. 55 | 11 | AnAr 64-1-65 (CTH 470). 4,6 × 4,2 cm. Öy. 9’: DINGIR-LUM. |
| Nr. 56 | 11 | AnAr 14973 (CTH 470 ya da 448 ?). 1,7 × 2,2 cm. St. 3’deki <i>tarpalli</i> - için krş. AnAr 11503 a+d (ABoT II 31) st. (2’), 6’, KUB 17.18 II 27, III (5), KUB 60.161 II 5, 8 (hepsi CTH 448). |
| Nr. 57 | 11 | AnAr 4220 r (CTH 470 ya da 530). 3,0 × 4,2 cm. St. 1’: HÁD.D[U.A]; 2’: BAPPİR. |
| Nr. 58 | 11 | AnAr 14951 (CTH 470 ya da 530). 3,1 × 3,0 cm. (Bayram) ritualine ait malzemeyi sayar; krş. KBo 5.2 I 17 vdd. (CTH 424), KUB 7.20 öy. 7 vdd. (CTH 426), KUB 32.129 I 7, 9-10 (CTH 474), KUB 32.133 I 11-13 (CTH 431). |
| Nr. 59 | 11 | AnAr 6992 (CTH 470 ya da 670). 4,3 × 3,3 cm. Ritual ya da bayram tasviri. |
| Nr. 60 | 12 | AnAr 8360 ı (CTH 470 ya da 670). 2,5 × 3,4 cm. Ay. 2’: [<i>d</i>]- <i>a-m</i> ¹ <i>e-e-d</i> ¹ <i>a-ni pí</i> -[<i>di</i>]; 4’: ¹ PA ¹ -NI ^{NA} [² ZI. KIN]. |
| Nr. 61 | 12 | AnAr 8365 f (CTH 470 ya da 670). 1,8 × 2,5 cm. St. 1’: GÍŠERIN- <i>i</i> [a] ya da GÍŠERIN. ¹ TUR ¹ ? |
| Nr. 62 | 12 | AnAr 9138 (CTH 470 ya da 670). 3,8 × 3,5 cm. I ² 4’: [<i>hur</i> - ya da <i>ú</i>]- <i>nu-ya-an</i> ; 7’: [<i>p</i>]- <i>i-ra-an</i> . |
| Nr. 63 | 12 | AnAr 9166 (CTH 470 ya da 670). 4,0 × 6,8 cm. St. 3’: ¹ <i>pé-e-d</i> ¹ <i>a-a</i> [<i>n-zi</i>]. |
| Nr. 64 | 12 | AnAr 9465 (CTH 470 ya da 670). 2,9 × 3,6 cm. St. 5’-6’ Hititçe olmayabilir. St. 1’: I UDU; 3’: ⁴ É. ¹ AI ¹ ? |
| Nr. 65 | 12 | AnAr 9715 (CTH 470 ya da 670). 2,0 × 2,7 cm. St. 4’: [... H]IA <i>har-t</i> [<i>e</i> -...]. |
| Nr. 66 | 12 | AnAr 10322 (CTH 470 ya da 670). 3,2 × 2,5 cm. |
| Nr. 67 | 13 | AnAr 10592 (CTH 470 ya da 670). 6,4 × 3,4 cm. St. 6’’: [<i>me</i>]- <i>ma-al</i> ; 8’’: [¹ Š] ^G <i>mi-ti-iš</i> . |
| Nr. 68 | 13 | AnAr 10598 (CTH 470 ya da 670). 6,4 × 2,6 cm. Öy. ² 6’’: [DU]G.KAŠ XII ¹ NINDA ¹ .GU[R ₄ .RA.HI.A]. |
| Nr. 69 | 13 | AnAr 10603 (CTH 470 ya da 670). 2,8 × 3,1 cm. |
| Nr. 70 | 13 | AnAr 11246 d (CTH 470 ya da 670). 3,0 × 3,3 cm. St. 5’: [<i>ua</i>]- <i>ra-a-ni</i> . |
| Nr. 71 | 13 | AnAr 11246 e (CTH 470 ya da 670). 3,3 × 2,0 cm. St. 2’: “LXXX”; 4’: KU ₆ .HI.A. |

Katalog

| Tablet | Levha | Tanımlama |
|---------|-------|---|
| Nr. 72 | 13 | AnAr 11391 (CTH 470 ya da 670). 4,5 × 1,9 cm. Öy. [?] 4': <i>a-aš-k[i]</i> (foto). |
| Nr. 73 | 13 | AnAr 11396 (CTH 470 ya da 670). 1,5 × 3,7 cm. |
| Nr. 74 | 14 | AnAr 11614 a (CTH 470 ya da 670). 4,3 × 3,9 cm. St. 6': <i>[d]a-pí-an ME-E</i> . |
| Nr. 75 | 14 | AnAr 11616 b (CTH 470 ya da 670). 3,6 × 2,0 cm. Ay. [?] 5': <i>i-ja-an-na-[i]</i> . |
| Nr. 76 | 14 | AnAr 14453 (CTH 470 ya da 670). 5,6 × 6,8 cm. II [?] 7': <i>nu-uš-^lma^l-[aš]</i> . |
| Nr. 77 | 14 | AnAr 12131 f (CTH 470 ya da 670). 2,9 × 3,0 cm. St. 2': <i>[an-t]u²-uḫ-ša-aš-š[a²]</i> . |
| Nr. 78 | 14 | AnAr 12131 h (CTH 470 ya da 670). 3,0 × 1,9 cm. |
| Nr. 79 | 14 | AnAr 12131 k (CTH 470 ya da 670). 1,7 × 2,2 cm. |
| Nr. 80 | 14 | AnAr 14931 (CTH 470 ya da 670). 2,1 × 4,1 cm. St. 4' Hititçe değil. |
| Nr. 81 | 15 | AnAr 14933 (CTH 470 ya da 670). 3,3 × 2,1 cm. 6'. satırdaki tanrı ismi ^d <i>A-la-w[a-...]</i> belki ^d <i>Alawayaimi</i> 'ye ait olacaktır; krş. KUB 30.56 III 18. |
| Nr. 82 | 15 | AnAr 14958 (CTH 470 ya da 670). 3,9 × 3,0 cm. |
| Nr. 83 | 15 | AnAr 14965 (CTH 470 ya da 670). 3,0 × 3,7 cm. St. 8': ^l <i>a-ru^l-um-ma-aš-^lša^l</i> (foto). |
| Nr. 84 | 15 | AnAr 14994 (CTH 470 ya da 670). 3,1 × 3,0 cm. 5'-6'. satırlar için krş. KUB 56.55 I 12 (CTH 456). |
| Nr. 85 | 15 | AnAr 15155 (CTH 470 ya da 670). 4,0 × 4,3 cm. |
| Nr. 86 | 15 | AnAr 21631 (CTH 470 ya da 670). 3,2 × 3,4 cm. |
| Nr. 87 | 15 | AnAr 21730 (CTH 470 ya da 670). 2,3 × 2,3 cm. |
| Nr. 88 | 15 | AnAr 4220 e (CTH 470 ya da 670). 3,1 × 3,0 cm. |
| Nr. 89 | 16 | AnAr 28-1-66 (CTH 470 ya da 670). 4,2 × 2,9 cm. |
| Nr. 90 | 16 | AnAr 16-5-68 (CTH 470 ya da 670). 7,2 × 3,2 cm. İçerikçe bir Kizzuwatna ritualine (CTH 500) benzemektedir. Fragman, 1968 yılında diğer tablet parçaları ile beraber (ABoT II 144, 214-17, 219-21 ve 230) D. Owen tarafından Boğazköy'de satın alınıp, Ankara Anadolu Medeniyetleri Müzesi'ne hediye edilmiştir. |
| Nr. 91 | 16 | AnAr 80-4-74 (CTH 470 ya da 670). 2,0 × 2,3 cm. St. 2': <i>SILA₄.G[E₆]</i> (foto); 3': ^[MUNU] <i>skat-ri-iš-ša</i> (krş. KUB 32.133 IV 2'). |
| Nr. 92 | 16 | AnAr 9464 (CTH 474.C). 5,7 × 6,2 cm. Laroche, CTH, s. 82'ye alınmıştır. |
| Nr. 93 | 17 | AnAr 11618 (CTH 475). 4,9 × 3,4 cm. 1'-9'. satırlar KBo 9.119A I 9'-16' ve Bo 69/630 öy. [?] sağ sütun 4'-10'a duplikattır. |
| Nr. 94 | 17 | AnAr 6984 (CTH 500 ?). 4,3 × 4,6 cm. Herhalde bir Kizzuwatna rituali fragmanı; 3'. satır için krş. KBo 21.45 I 16'. |
| Nr. 95 | 17 | AnAr 6987 (CTH 500 ?). 3,7 × 3,6 cm. St. 2'-6' için krş. KBo 33.35 ay. [?] 6'-9' (CTH 790). |
| Nr. 96 | 17 | AnAr 7007 (CTH 500 ?). 3,5 × 4,8 cm. |
| Nr. 97 | 17 | AnAr 8358 a+b (CTH 500 ?). 3,4 × 2,9 cm. |
| Nr. 98 | 17 | AnAr 8360 a (CTH 500 ?). 2,7 × 3,5 cm. |
| Nr. 99 | 17 | AnAr 8363 (CTH 500). 8,1 × 3,2 cm. St. 13'-14' için krş. KUB 29.7 ay. 47'-48' (CTH 480). |
| Nr. 100 | 17 | AnAr 8847 (CTH 500 ?). 3 × 2 cm. St. 1': <i>[ki²-i]^lš-ša-r^l[a-...]</i> ; 3': <i>nu-uš-š[a-an]</i> . |
| Nr. 101 | 18 | AnAr 9157 (CTH 500 ?). 11,8 × 2,7 cm. Bu fragman, KBo 41.114 (<i>Konkordanz</i> 'da CTH 832 olarak verilmektedir) ile direk join olmuştur (R. Akdoğan). Kizzuwatnalı kutsal varlıklara sunulan hayvan kurban ve yakılan kuş listesini içerir; benzerleri ABoT 19 (CTH 706), KBo 33.169 (CTH 705) |

Katalog

| Tablet | Levha | Tanımlama |
|---------|-------|---|
| | | ve KBo 2.18 (CTH 787.1)'dir. Ancak, AnAr 9157 ile ABoT 19 (= AnAr 9161) aynı tablete ait değildirlir. |
| Nr. 102 | 18 | AnAr 10310 (CTH 500). 5,7 × 4,3 cm. II ³ 9': I ŠU-Š[I]. |
| Nr. 103 | 18 | AnAr 10313 (CTH 500 ?). 4,5 × 4,5 cm. Öy. 3: da-[an-zi]; 6-7: I ^{DUG} kap-[pí-iš ...] / [k]a-ap-pa-ru-ma-aš ^{GI} [š ...] (krş. VBoT 89 I 12'-13'). |
| Nr. 104 | 18 | AnAr 10587 (CTH 500). 4,0 × 5,3 cm. 4'-5'. satırlar için krş. KBo 10.20 IV 2-3 (CTH 604.A). |
| Nr. 105 | 19 | AnAr 10865 (CTH 500 ?). 8,0 × 6,2 cm. Kizzuwatna rituali (CTH 790) ya da Kizzuwatnalı kutsal varlıklar için kurban listesi (CTH 705). |
| Nr. 106 | 19 | AnAr 11246 g (CTH 500). 1,8 × 3,7 cm. 2'. satırda ^d Kulitta anmaktadır. |
| Nr. 107 | 19 | AnAr 11388 (CTH 500). 2,6 × 3,5 cm. St. 1': [še-pí-i]I ^{t-ta} ; 3': [ši-pa-a]n-ti. |
| Nr. 108 | 19 | AnAr 11408 (CTH 500 ?). 4,3 × 4,6 cm. |
| Nr. 109 | 19 | AnAr 11620 a (CTH 500). 3,7 × 3,7 cm. 3'. satır için krş. KUB 32.129 I 9. AnAr fragmanındaki "8" sayısının ilginç yazımı (üstüste yazılmış dörder dikey şekilde) dikkati çekmektedir. |
| Nr. 110 | 19 | AnAr 14919 (CTH 500). 3,9 × 4,9 cm. Öy. 2-3. satırlar için krş. IBoT 3.99:4'-5' ve KUB 9.34 I [3]-4' (CTH 760). |
| Nr. 111 | 20 | AnAr 14955 (CTH 500). 2,7 × 1,9 cm. St. 2'-4' için krş. KBo 24.45 ay. 10-11 ve KBo 27.202:5'-10' (CTH 479). |
| Nr. 112 | 20 | AnAr 90-4-68 (CTH 500). 2,0 × 4,3 cm. St. 3': [SÍG].SA ₃ ; 4': [A-NA] I ^{EN} .SISKUR še-er ar-ḫa [ḡa-aḫ-nu-zi]. |
| Nr. 113 | 20 | AnAr 11615 (CTH 500 ya da 530). 3,2 × 2,8 cm. Kizzuwatna rituali ya da kült envanteri. |
| Nr. 114 | 20 | AnAr 14922 (CTH 500 ya da 628 ?). 4,9 × 5,6 cm. Bir Kizzuwatna ritual ya da bayramı; <i>Hišuw</i> a Bayramı'na da ait olabilir. |

Din Hayatı ile İlgili İdarî Metinler (CTH 501-530 "Administration Religieuse")

| | | |
|---------|----|--|
| Nr. 115 | 20 | AnAr 6964 + 6991 (CTH 523 ?). 7,5 × 6,4 cm. Erzak / MELQĒT-listesi ? Benzer listeler için ayrıca krş. KBo 11.36 IV 4-7 (CTH 523) ve KUB 58.27 II 1-17 (CTH 635). |
| Nr. 116 | 20 | AnAr 10326 (CTH 530 ?). 2,7 × 1,7 cm. Kült envanteri ? |
| Nr. 117 | 21 | AnAr 10606 (CTH 530). 8,0 × 8,5 cm. Öy. 8': I ^{II} DUG.KAŠ; 9': pé-e[š-kán-zi]; ay. 2': [LÚ.M]EŠ URU-LIM. |
| Nr. 118 | 21 | AnAr 10871 (CTH 530). 6,4 × 2,9 cm. Öy. 6': ma-al-li-iš-ká[n-zi]. |
| Nr. 119 | 22 | AnAr 11499 (CTH 530). 5,4 × 4,5 cm. 1'. satırda [^{UZU} H]A-KU-RA-TU ₄ anar; krş. KBo 22.222 III (5') (CTH 530). |
| Nr. 120 | 22 | AnAr 14913 (CTH 530; <i>Konkordanz</i> : CTH 670). 8,3 × 3,7 cm. Krş. CTH 506, 525.3 ve özellikle 511.1. Metin, Akdoğan-Soysal, <i>AMMY</i> 2002, 176'-79'da incelenmiştir. |
| Nr. 121 | 22 | AnAr 3544 (CTH 530). 7,3 × 4,9 cm. ^d Šu-ú-i-ta ve ^m Up-pa-ti-ši-pa (öy. 7') anmaktadır. Tanrı adı için bkz. ^d Šu-ú-i-en-ta-an (KUB 57.102 IV ² 4'). |
| Nr. 122 | 23 | AnAr 10315 (CTH 530 ya da 670). 3,4 × 4,3 cm. Bkz. Akdoğan, <i>AMMY</i> 2005, 199-200. |
| Nr. 123 | 23 | AnAr 11613 c (CTH 530 ya da 670). 4,5 × 5,2 cm. Bayram tasviri, kült envanteri ya da bayram hakkında fal olabilir; öy. 2'. satır için krş. ABoT 14 V 8' (CTH 568) ve KUB 51.12 öy. 3 (CTH 670). Bkz. Akdoğan, <i>AMMY</i> 2005, 205-06, 220. |

Katalog

Tablet Levha

Tanımlama

Kehanet Metinleri (CTH 531–590 “Divination”)

- Nr. 124** 23 AnAr 14920 (CTH 538.I). 7,2 × 4,9 cm. Akkadça kehanet metni; bkz. Akdoğan-Soysal, *AMMY* 2002, 181–83.
- Nr. 125** 24 AnAr 11407 (CTH 547.I). 8,6 × 11,6 cm. Akkadça karaciğer modeli; Riemschneider, *DBH* 12, 159’da bahsedilir. 1. satır için bkz. KBo 9.63 öy. A 2 ve KBo 9.64 A 1.
- Nr. 126** 24 AnAr 8357 b+c+d+e+g+h (CTH 560). 5,6 × 4,4 cm. Türü kesin olarak saptanamayan bir kehanet metni. Eski Hititçe örneğe geri gittiğini *takku* giriş kelimesi göstermektedir.
- Nr. 127** 24 AnAr 10609 (CTH 570). 4,7 × 2,7 cm. 2’–12’. satırlar KUB 5.6 III 24’–38’e duplikattır.
- Nr. 128** 25 AnAr 10872 (CTH 570). 5,0 × 3,4 cm. “SU” falı. St. 4’: [EGIR-Š]Ú šu-ri<-iš> XII [ŠÀ TIR ...]; 6’: [EGIR-Š]Ú; 9’’: GIŠITUKUL.
- Nr. 129** 25 AnAr 8357 a (CTH 572). 4,1 × 1,9 cm. “KIN” falı. St. 6’: [EGIR²-p]a DU-u-e-ni (= *paiweni*).
- Nr. 130** 25 AnAr 8840 (CTH 572 ?). 3,8 × 3,2 cm. Öy. 6’: x x KI.GUB.
- Nr. 131** 25 AnAr 9163 (CTH 572). 4,9 × 5,0 cm. III² 4’: da-p[*i-an*]; 6’: H[U[L-lu]; IV² 4’: [mi-nu-m]ar^{III.A}.
- Nr. 132** 25 AnAr 11246 I (CTH 572 ?). 2,6 × 2,2 cm.
- Nr. 133** 25 AnAr 11387 (CTH 572). 2,9 × 5,0 cm.
- Nr. 134** 25 AnAr 12174 (CTH 572). 3,7 × 2,2 cm.
- Nr. 135** 25 AnAr 12216 (CTH 572). 3,0 × 2,2 cm. St. 4’: [d]a-pí-an Z[I-an].
- Nr. 136** 26 AnAr 10757 (CTH 574). 6,5 × 6,6 cm. “MUŞEN HURRI” falı; ay. 5’, 10’, 11’de sıkça tekrarlanan ^{DUG}haršiyalli için krş. KUB 5.7 öy. 2, 12.
- Nr. 137** 26 AnAr 15151 (CTH 580) 6,9 × 7,2 cm. “MUŞEN” ve “KIN” falı. AnAr 15151 ile KUB 5.17 öy. I join olmaktadır (Y. Sakuma).

Bayram ve İbadet Metinleri (CTH 591–720 “Fêtes et Cultes”)

- Nr. 138** 26 AnAr 90-6-68 (CTH 591). 4,5 × 2,4 cm. EZEN.ITU Bayramı. St. 3’ vdd. için krş. KBo 20.67 IV 16 vdd., KBo 17.88 III 10’ vdd., 23’ vdd., KBo 22.201 III 1’ vdd., IV 3 vdd.
- Nr. 139** 26 AnAr 70-1-76 (CTH 627) 5,9 × 8,8 cm. KILAM Bayramı. O. Soysal tarafından H. G. Güterbock’un 1934’de yaptığı transkripsiyona dayanılarak “Ankara 1934” ismiyle *JCS* 50, 59–65’de yayımlanan fragman. Bu parçanın şimdi AnAr metinleri arasında ortaya çıkmasına rağmen, aynı tablete ait olması gereken “İzmir 1270++” parçasının akıbeti henüz belli değildir; tabletin hikayesi için bkz. O. Soysal, a. g. y. 63.
- Nr. 140** 27 AnAr 10285 (CTH 628). 6,3 × 7,7 cm. Hişuwa Bayramı. Laroche, CTH, s. 112’ye “*autres fragments*” altında alınmıştır. Tablet yüzeyi çok döküldüğünden işaretler iyi seçilememektedir. O nedenle burada, kopya yerine tabletin fotoğrafı verilmiştir.
- Nr. 141** 28 AnAr 12157 (CTH 628). 4,7 × 4,7 cm. I 2’–9’. satırlar KUB 32.128 I 9–15’e duplikattır.
- Nr. 142** 28 AnAr 8360 i (CTH 634). 3,0 × 2,9 cm. 1’–7’. satırlar için krş. KBo 8.121:6’–9’, KBo 46.142 sağ sü. 5’–9’ ve KUB 25.3 öy. III 21–26.
- Nr. 143** 28 AnAr 96-2-76 (CTH 635). 3,7 × 2,7 cm. Öy. 2’–6’. satırlar KUB 11.30 + KUB 44.14 IV 22’–27’ye duplikat ya da paraleldir. Bu fragman, “Kuşsaray” tabletleri arasında bulunmaktadır. Koşay, “Kuşsaray,” s. 89’da Kuşsaray ile ilgili şu bilgileri verir:

“*Milli Eğitim Bakanlığı 24 Mayıs 1966 tarihli buyruğu üzerine Alacahöyük kazı heyeti Çorum’un 15 km. doğusunda, birkaç parça kırık Hitit tableti de bulunduğu söylenen Kuşsaray Höyüğünde 18–25 Temmuz 1966 tarihleri arasında Bakanlık ve Türk Tarih Kurumu adına 14 işçi ile sondaj ve araştırmalar yapmıştır*”.

Katalog

| Tablet | Levha | Tanımlama |
|---------|-------|---|
| Nr. 144 | 28 | AnAr 16-6-68 (CTH 643; bkz. <i>Konkordanz</i>). 3,6 × 3,7 cm. D. Owen tabletlerinden. 2'-7'. satırlar KUB 25.33 I 3-8'e duplikat olmaktadır. |
| Nr. 145 | 28 | AnAr 9723 (CTH 645). 4,5 × 4,3 cm. II ² 8'-9'. satırlar KUB 58.38 II 2'-3', 8'-9', 15'-16' ve (23')'e paraleldir . |
| Nr. 146 | 28 | AnAr 12156 (CTH 645 ya da 458). 4,8 × 5,2 cm. 2'-11'. satırlar 942/z (krş. Neu-Otten, <i>IF</i> 77, 183) öy. ² 1'-5' ve ay. ² 1'-3'e duplikattır. St. 5'deki [DINGIR p]i ² šeneš ve DINGIR <i>mališmiš</i> dolayısıyla KUB 43.30 III 10'-11' ve KBo 43.75:6'-7' (CTH 645) ya da KUB 41.23 III 12' (CTH 458.10)'yi çağrıştırmaktadır. |
| Nr. 147 | 28 | AnAr 11502 c (CTH 647). 2,1 × 2,5 cm. 1'-5'. satırlar KBo 11.45 öy. III 13'-17'ye duplikattır. |
| Nr. 148 | 29 | AnAr 10311 (CTH 648). 5,8 × 5,9 cm. Ay. 4' vdd. için krş. KBo 25.67 sağ sü. 12' vdd., KBo 30.99 I 2' vdd., KUB 54.50 I ² 11' vdd. |
| Nr. 149 | 29 | AnAr 10300 (CTH 649). 3,2 × 4,5 cm. NIN.DINGIR rahibesini anan bayram tasvirlerinden. Öy. 5'de [GİS ² hul]u ² ganni anmaktadır; krş. KBo 17.101 öy. III 11', 15'. |
| Nr. 150 | 29 | AnAr 12176 (CTH 649). 3,0 × 4,5 cm. St. 1': [kar-ap-zi]; 2': NIN.DINGIR-i IGI-[an-da]; 3': NIN.DINGIR tu-[u ¹]-[ua-az]. |
| Nr. 151 | 29 | AnAr 4220 d (CTH 649). 2,6 × 3,0 cm. 3'. satırdaki [NI]N.DINGIR-i parā ē[pzi] için krş. KBo 24.98:10', KUB 53.28 öy. 6'. |
| Nr. 152 | 29 | AnAr 70-2-76 (CTH 664). 6,3 × 4,0 cm. Bkz. Akdoğan-Soysal, <i>AMMY</i> 2002, 180-81. |
| Nr. 153 | 29 | AnAr 10299 ([CTH 669] <i>Düzeltilme eki</i> : Büyük olasılıkla CTH 448). 4,6 × 4,0 cm. 2'-10'. satırlar için krş. duplikat, paralel ya da benzer KBo 39.94 öy. ² 1'-8' (CTH 448.4.5), KBo 15.16 öy. ² II 2'-6' (CTH 448.4.3.b; metin için bkz. Kümmel, <i>StBoT</i> 3, 138), KBo 16.103:2'-5' (CTH 832) ve IBoT 3.129 öy. 1'-10' (CTH 448.4.6). |
| Nr. 154 | 29 | AnAr 3137 (CTH 670). 5,4 × 2,7 cm. St. 2': [ki-i]t-kar-za; 3': [ša]-aš-[ti ¹]. |
| Nr. 155 | 29 | AnAr 6995 (CTH 670 ?). 4,4 × 3,2 cm. St. 5': ma-a-n[a-aš(-)...]. |
| Nr. 156 | 30 | AnAr 8357/f (CTH 670). 3,0 × 2,4 cm. |
| Nr. 157 | 30 | AnAr 8360 c+ğ+m (CTH 670). 3,3 × 3,0 cm. St. 5': [L ^U GU]DU ₁₂ . |
| Nr. 158 | 30 | AnAr 8360 f (CTH 670). 3,0 × 3,1 cm. St. 6': [pa-iz-zi ¹]. |
| Nr. 159 | 30 | AnAr 8360 h (CTH 670). 2,8 × 2,5 cm. St. 2': [ya-a]l- <i>ha-an-ni-a</i> [n-zi]; 4': [h]u-ke-eš-kán-z[i]. |
| Nr. 160 | 30 | AnAr 8360 n+s+ş (CTH 670, belki de 651). 2,4 × 2,9 cm. Satır 2'de [MUNUS.MEŠ(?)h]a-az-ka ₄ -ra-i anar; krş. KUB 9.30:5'-7', KUB 58.4 V 11'-14' ve KUB 58.1 I (1'-4') (hepsi CTH 651). |
| Nr. 161 | 30 | AnAr 8365 b (CTH 670 ?). 2,4 × 1,6 cm. |
| Nr. 162 | 30 | AnAr 8857 (CTH 670, ya da büyük olasılıkla ile 824). 4,4 × 3,7 cm. Pekçok yönüyle KBo 22.242 (CTH 824) metnini hatırlatmaktadır. St. 6': L ^U .MEŠ ² KUŠ ₇ .GUŠKIN. |
| Nr. 163 | 30 | AnAr 8911 (CTH 670). 5,3 × 5,4 cm. Ay. 4': [na-at ¹ GE ₆ -an hu-u-ma-[an-da-an]. |
| Nr. 164 | 31 | AnAr 8919 (CTH 670). 3,8 × 4,3 cm. 1'-6'. satırlardaki tasvir KUB 57.99 IV 3'-7' (CTH 618.5)'e benzer; ayrıca krş. KBo 39.86 II 14'-16' (CTH 660.4). |
| Nr. 165 | 31 | AnAr 9145 (CTH 670 ?). 3,8 × 3,6 cm. Bayram tasvirine benzemekle beraber, öy. ² II 2'-3'de ikinci şahısa bir seslenme durumu vardır; o nedenle fragman başka bir metin grubuna da ait olabilir (dua, adak vs. gibi). |
| Nr. 166 | 31 | AnAr 9716 (CTH 670). 3,1 × 2,2 cm. St. 2': dUTU ^{UR} [UArinna] ? |
| Nr. 167 | 31 | AnAr 9720 (CTH 670 ?). 2,4 × 2,3 cm. Bkz. Akdoğan, <i>AMMY</i> 2005, 204-05, 219. |

Katalog

| Tablet | Levha | Tanımlama |
|---------|-------|--|
| Nr. 168 | 31 | AnAr 9730 (CTH 670). 4,9 × 3,3 cm. Öy. 3': [ša ² -r]a-a; 4': [gal-gal-tu-u ²]-ri; 5': [ha-az-zi-i]k-kán-zi. |
| Nr. 169 | 31 | AnAr 10301 (CTH 670). 2,6 × 3,2 cm. LUGAL, GAL MEŠEDI ve memal konteksli 3'-4'. satırlar için krş. KBo 23.79 II 1-2 (CTH 675), KBo 11.52 VI 22'-23' (CTH 634.1.B) ve KUB 34.69 + KUB 34.70 öy. 11'-12' (CTH 609). |
| Nr. 170 | 32 | AnAr 10309 (CTH 670). 7,6 × 5,0 cm. |
| Nr. 171 | 32 | AnAr 10325 (CTH 670). 3,2 × 2,0 cm. St. 2': I GÍN; 3': da-pí-î[a-an ²]; 4' ve 6' EGIR-ŠU-ma a-[la-an-ni ...] (krş. KBo 33.201 öy. ² III 13'-15') ya da A-[NA ^d ...] olarak mı tamamlanacak ? |
| Nr. 172 | 32 | AnAr 10588 (CTH 670 ?). 6,4 × 2,6 cm. St. 13': [te]-li-pu-u-ri. |
| Nr. 173 | 32 | AnAr 10593 (CTH 670). 5,2 × 5,6 cm. II ² 7' ve 9'. satırlardaki ^d Karzi ve irhāuwar kelimesi için krş. KBo 21.64 III 5, (12) ve KUB 2.13 V 5. |
| Nr. 174 | 33 | AnAr 10596 (CTH 670 ya da daha çok 651). 6,2 × 4,4 cm. II ² 1'-12'. satırlar KUB 58.1 I 6'-17' (CTH 651)'ye duplikat ya da paraleldir. |
| Nr. 175 | 33 | AnAr 10597 (CTH 670). 4,2 × 5,5 cm. Öy. 3'. satırdaki nu MUNUS.LUGAL arāi için bkz. KUB 32.87 ay. 26 (CTH 646.1.A) ve ayrıca krş. KBo 29.188 IV 14' (CTH 694). |
| Nr. 176 | 33 | AnAr 10604 (CTH 670). 3,3 × 3,6 cm. |
| Nr. 177 | 33 | AnAr 10611 (CTH 670). 3,5 × 3,3 cm. St. 3': [me ²]-[e ¹ -mi-iš-ki-iz-z[i]. |
| Nr. 178 | 34 | AnAr 10758 (CTH 670). 9,6 × 9,4 cm. 9'-10'. satırlar KBo 24.103 V 2'-4' (CTH 670)'e duplikat ya da paraleldir; ayrıca krş. KBo 15.36 III 10'-12' (CTH 330.3.A). Metnin yazısı, Orta Hitit duktusu özellikleri göstermektedir. |
| Nr. 179 | 34 | AnAr 10866 (CTH 670). 5,1 × 5,9 cm. St. 4': ta-ma-iš; 5': GİŠERIN BIR ₉ R[A] "yanmış sedir odunu". |
| Nr. 180 | 34 | AnAr 11246 h (CTH 670 ?). 2,8 × 2,2 cm. Ekmek (kurban) listesi içerir. St. 1': [NINDA.GUR ₄ R]A. |
| Nr. 181 | 34 | AnAr 11288 a (CTH 670). 8,4 × 3,4 cm. |
| Nr. 182 | 34 | AnAr 11288 b (CTH 670). 5,0 × 3,3 cm. Büyük olasılıkla ABoT II 181 (AnAr 11288 a) ile aynı tablete aittir, ancak aralarında direkt birleşme bulunmamaktadır. |
| Nr. 183 | 34 | AnAr 11385b (CTH 670). 2,3 × 2,9 cm. |
| Nr. 184 | 35 | AnAr 11402 a (CTH 670 ya da 738). 2,3 × 2,6 cm. St. 1': [ha-a]z-[ze ¹ -eš-kán-z[i]; 1'-3'. satırlar KBo 19.138 öy. 5'-7' (CTH 738.I.7.B)'ye duplikat ya da paraleldir; ayrıca krş. KBo 24.98:1'-2' (CTH 738.I.7.A). |
| Nr. 185 | 35 | AnAr 11503 b (CTH 670). 3,3 × 2,2 cm. |
| Nr. 186 | 35 | AnAr 11504 (CTH 670). 3,1 × 1,9 cm. |
| Nr. 187 | 35 | AnAr 11619 a (CTH 670). 3,8 × 4,1 cm. |
| Nr. 188 | 35 | AnAr 11621 b (CTH 670 ?). 3,2 × 3,2 cm. 3'-4'. satırlar için krş. KUB 2.6 II 1-2 (CTH 598.1.A). |
| Nr. 189 | 35 | AnAr 12166 (CTH 670). 7,7 × 4,5 cm. St. (1'), (12'), (14'): LÚha-mi-na(-aš); 8': I ú-ri-ja-a[š-ša ² -an ²]; (13'), (19'), (20'): NINDAši-lu-ħa-a-an(-ma); 22': ku-ri-[ya ²]-nu-uš-ša. |
| Nr. 190 | 35 | AnAr 12169 (CTH 670). 3,2 × 3,9 cm. Tanrılara kurban listesi içermektedir; bkz. Akdoğan, AMMY 2005, 198-99. |
| Nr. 191 | 35 | AnAr 12178 (CTH 670 ?). 3,6 × 1,7 cm. |
| Nr. 192 | 35 | AnAr 12186 (CTH 670). 2,1 × 0,8 cm. Sol kenar 2'. satırda URUDa-a-ú-[ni-ja] şehri anılır. Yazısı Orta Hitit duktusunu andırmaktadır. |
| Nr. 193 | 36 | AnAr 12188 (CTH 670). 3,7 × 3,4 cm. |

Katalog

| Tablet | Levha | Tanımlama |
|---------|-------|---|
| Nr. 194 | 36 | AnAr 14839 b (CTH 670). 6,2 × 5,7 cm. Öy. 2'-4' satırlar için krş. VS 28.33 III 25-26, 28-29; bkz. Akdoğan, <i>AMMY</i> 2005, 204, 218. |
| Nr. 195 | 36 | AnAr 14839 c (CTH 670). 3,5 × 2,5 cm. 1'-7'. satırlar için krş. KUB 53.44 IV 1' vdd., 4'-6' (CTH 647.16). |
| Nr. 196 | 36 | AnAr 14923 (CTH 670). 5,9 × 4,2 cm. Öy. [?] I [?] 10': <i>ir-ḫa-[iz-z]i</i> . |
| Nr. 197 | 36 | AnAr 14926 (CTH 670). 6,3 × 3,5 cm. |
| Nr. 198 | 36 | AnAr 14927 (CTH 670). 4,0 × 2,2 cm. St. 6': [LÚ]ALAN.Z]U ₉ . |
| Nr. 199 | 36 | AnAr 14928 (CTH 670 ?). 4,8 × 4,6 cm. Öy. 2. satır [UR]U _{Zi-ip-pal-an-da} yazımı ile dikkat çekmektedir. |
| Nr. 200 | 36 | AnAr 14936 (CTH 670 ?). 3,5 × 2,5 cm. |
| Nr. 201 | 37 | AnAr 14939 (CTH 670 ?). 2,7 × 1,9 cm. St. 1': [N] ^A ZI.KIN.ḪI.†A ¹ . |
| Nr. 202 | 37 | AnAr 14942 (CTH 670). 2,6 × 2,2 cm. |
| Nr. 203 | 37 | AnAr 14967 (CTH 670). 2,6 × 2,3 cm. |
| Nr. 204 | 37 | AnAr 14970 (CTH 670). 2,0 × 4,2 cm. |
| Nr. 205 | 37 | AnAr 14971 (CTH 670 ya da 663 ?). 4,6 × 2,7 cm. Burada 5' satırdaki gibi LÚ.MEŠ DUGUD(-TIM) içeren kült tasvirleri için bkz. HT 19:7'-9' (CTH 663.4.A), IBoT 2.65:10'-11' (663.4.B), IBoT 3.23 öy. [?] III [?] 10'-13' (CTH 663), KUB 28.97 III 9'-10' (CTH 744). |
| Nr. 206 | 37 | AnAr 14972 (CTH 670). 2,4 × 2,1 cm. 2'-3'. satırlar için krş. KBo 20.74 ay. [?] III 10'-11' (CTH 635 ?). |
| Nr. 207 | 37 | AnAr 14984 (CTH 670 ?). 1,6 × 2,3 cm. St. 1': [LÚ]ki-ta-a ¹ -[aš]; 3': DINGIR.LÚ.MEŠ. |
| Nr. 208 | 37 | AnAr 15160 (CTH 670 ?). 3,4 × 0,9 cm. |
| Nr. 209 | 37 | AnAr 21627 (CTH 670). 3,4 × 5,6 cm. Ay. 2': XXIV-†ŠU ¹ . Ay. 4'-8'. satırlar KUB 33.79 ay. [?] IV 4'-9' (CTH 332.4)'e benzer. |
| Nr. 210 | 38 | AnAr 21632 (CTH 670). 4,2 × 3,3 cm. Öy. 4: [ar-ḫ]a; 6: BÉ-EL S[ISKUR [?]]. |
| Nr. 211 | 38 | AnAr 21633 (CTH 670). 2,8 × 3,8 cm. St. 7': †LUGAL-uš ¹ . 2'-7'. satırlara benzeyen tasvirler için krş. KBo 34.146 IV 2'-5' (CTH 591.I.b.C), KBo 41.86 II 2'-5' (CTH 650), KBo 25.105 ay. 2'-4' (CTH 669.25.C). |
| Nr. 212 | 38 | AnAr 28-3-66 (CTH 670 ?). 2,9 × 3,0 cm. |
| Nr. 213 | 38 | AnAr 151-1-67 (CTH 670). 6,8 × 4,6 cm. Krş. CTH 669, 675 ve 744.19. Metin çalışması için bkz. Akdoğan-Soysal, <i>AMMY</i> 2002, 172-76. |
| Nr. 214 | 38 | AnAr 16-1-68 (CTH 670; bkz. <i>Konkordanz</i>). 5,2 × 4,3 cm. D. Owen tabletlerinden. Öy. I [?] 2: [a]n-da; 3: [p]é-e-di ti-it-ta-nu-ḡ[a-an-zi]. |
| Nr. 215 | 38 | AnAr 16-2-68 (CTH 670; bkz. <i>Konkordanz</i>). 4,2 × 3,2 cm. D. Owen tabletlerinden. |
| Nr. 216 | 38 | AnAr 16-3-68 (CTH 670; bkz. <i>Konkordanz</i>). 3,9 × 3,2 cm. D. Owen tabletlerinden. |
| Nr. 217 | 39 | AnAr 16-4-68 (CTH 670; bkz. <i>Konkordanz</i>). 3,2 × 1,5 cm. D. Owen tabletlerinden. Tanrılara ekme kurban listesi içerir; krş. KBo 47.14 öy. 1' vdd. (CTH 470), KBo 53.146 öy. 1 vdd. (CTH 670), KUB 27.1 I 54 vdd. II 46 vdd. (CTH 712.A). <i>Düzeltilme eki</i> : ABoT II 217 şimdi KBo 54.222 (CTH 712) ile direkt join olmuştur. |
| Nr. 218 | 39 | AnAr 16-8-68 (CTH 670; bkz. <i>Konkordanz</i>). 2,8 × 4,8 cm. |
| Nr. 219 | 39 | AnAr 16-9-68 (CTH 670 [bkz. <i>Konkordanz</i>] ya da 790). 3,1 × 4,2 cm. D. Owen tabletlerinden. 2'. satırdaki [LÚ.ME]Š [?] zuppariyalle[š] ve 3'. satırdaki d ⁽¹⁾ apir[eš] için krş. KBo 39.187 + KBo 34.187 sağ sü. 11'-12', 14'-15' (CTH 670), KBo 39.190 II 4' (CTH 790), KUB 45.49 IV 3 (CTH 790). |
| Nr. 220 | 39 | AnAr 16-10-68 (CTH 670). 3,8 × 6,6 cm. D. Owen tabletlerinden. |

Katalog

| Tablet | Levha | Tanımlama |
|---------|-------|---|
| Nr. 221 | 39 | AnAr 16-11-68 (CTH 670). 3,9 × 1,8 cm. D. Owen tabletlerinden. Sol kenar 1'–2' [ANA GIŞ]. <i>ḪUR-kán</i> / [<i>ḫa-an-d</i>] <i>a-a-an</i> okunacaktır. |
| Nr. 222 | 39 | AnAr 90-2-68 (CTH 670). 4,9 × 3,3 cm. Öy. II ² 3', 7'–11' için krş. KBo 30.56 V 11', 15', 22'–29' (CTH 669). |
| Nr. 223 | 40 | AnAr 87-2-06 (CTH 670). 7,5 × 8,3 cm. Metin çalışması için bkz. Akdoğan, <i>AMMY</i> 2006, 163–77 ve eadem FsWilhelm'de, 17–26. Öy. II 8'deki <i>taknaš</i> ^d UTU(- <i>waš É</i>) ve ay. V 2'deki ^{LÚ} <i>ḫamina-</i> 'nın beraber belgelenmesi için krş. KBo 11.49 I 5', 9'–10' (CTH 592.2.II?.1.A) ve özellikle IBoT 3.44 öy. 3–4, ay. 5–6 (CTH 635 ?). |
| Nr. 224 | 40 | AnAr 4038 (CTH 670). 7,6 × 4,2 cm. Öy. 10': [<i>ḫal</i>]- <i>za-a-ḫi</i> !; 13': LUGAL- <i>i ḫpa-a</i> !-[<i>i</i>]. Öy. 3'–13'. satırlar için krş. KUB 25.9 III 4'–18' (CTH 634.2.B), KUB 1.17 I 2–12 (CTH 591.II.A), KBo 14.31 I 2–5 (CTH 670). |
| Nr. 225 | 40 | AnAr 11619 b (CTH 670 ya da 685 ?). 2,3 × 2,9 cm. Dinsel konulu. 2'. satırda ^d LAMMA anar ve bu nedenle bayram, ritual hatta mitolojik bir metin de olabilir. |
| Nr. 226 | 41 | AnAr 11202 (CTH 678). 16,0 × 8,4 cm. Ay. 9': [^d Ḫat] <i>epuna</i> ya da [^d Tel] <i>ipuna</i> ; 23': ^{LÚ} ḪSANGA! ^d U; 26': [GIŞ ^d INANN]A.GAL; 27': [^d Me- <i>ez-zu-ul-l</i>]a ḫTUŠ!- <i>aš</i> ; 28" ve 30": [S]ḪR-RU; 29": [^d U ^{URU} Zi- <i>i</i>]p- <i>la-an-ḫi</i> !a. |
| Nr. 227 | 42 | AnAr 12131 a (CTH 691). 4,7 × 6,6 cm. <i>Witaššiya</i> Bayramı. Öy. I ² 5': [<i>me</i>]- ^ḫ <i>e</i> !- <i>ḫu-ni</i> . Fragman Orta Hitit yazısı karakteri göstermektedir. Öy. II ² 1–5. satırlar KUB 27.59 I 6'–9'a paraleldir. |
| Nr. 228 | 42 | AnAr 10307 (CTH 692). 7,0 × 5,8 cm. <i>Witaššiya</i> Bayramı. Fragman Orta Hitit yazısı karakteri göstermektedir. Öy. 8' vdd. ve ay. 6' vdd. pasajlar için krş. KBo 24.22:2' vdd. AnAr 10307 büyük olasılık ile KBo 29.130 ile aynı tablete aittir. Her ikisi de tabletin sağ kenarını oluşturmaktadır ve KBo 29.130'un önyüzü tabletin sonu olduğu için AnAr 10307'nin, KBo 29.130 öy. 1'. satırının yukarısında bir yere denk düşmesi beklenir. |
| Nr. 229 | 43 | AnAr 26-1-68 (CTH 693 ?). 4,2 × 4,8 cm. St. 2' vdd. için krş. KBo 24.24 III 4' vdd. (CTH 693), KBo 14.89 + I 13' vdd. (CTH 693). |
| Nr. 230 | 43 | AnAr 16-7-68 (CTH 701; bkz. <i>Konkordanz</i>). 4,8 × 3,4 cm. D. Owen tabletlerinden. Öy. 7' vdd. için içerikçe krş. KBo 27.162 sağ sü. 4' vdd. (CTH 701.b ₂ .F), ay. 1'–4' için krş. KBo 23.45 IV 4, 12–16 (701.b.VII.A). |
| Nr. 231 | 43 | AnAr 21629 + KBo 11.5 + KBo 11.58 (CTH 703.2.B). 9,4 × 13,3 cm. Metin çalışması için bkz. Akdoğan-Wilhelm, <i>AMMY</i> 2001, 244–245; <i>ZA</i> 93 (2003) 223–27. |
| Nr. 232 | 44 | AnAr 9150 (CTH 704 ya da 705). 1,4 × 1,9 cm. Kizzuwatna (bayram) rituali ya da Hurri tanrılarına kurban listesi. Öy. 1'. satır [<i>tūn</i>]i <i>tapri</i> okunmalıdır; bunun için bkz. KUB 25.44 II 4' (CTH 704), KBo 23.67 II 9' (CTH 704) ve KBo 14.138:9 (CTH 705). Öy. 2'. satırdaki yer adı [^{URU} D]ašimūwa için krş. KUB 60.148 I 11'deki ^{URU} Tašimuaz. |

Yabancı Diller (CTH 725–791 “Langues Étrangères”)

| | | |
|---------|----|--|
| Nr. 233 | 44 | AnAr 12168 (CTH 732; <i>Konkordanz</i> : CTH 745). 4,8 × 4,6 cm. Hattice “Ḫutuši Rituali”. Bkz. Akdoğan-Soysal, <i>AMMY</i> 2002, 183–84. Soysal, <i>HWHT</i> , 68'de bahsedilmiş ve kelimeleri eserde kullanılmıştır. |
| Nr. 234 | 44 | AnAr 3136 (CTH 735; <i>Konkordanz</i> : CTH 745) 5,0 × 7,3 cm. Tek dilde yazılmış Hattice fragman. Eski Hitit yazı özellikleri göstermekte ve kompozisyon olarak KUB 28.23 (CTH 735)'e çok benzemektedir. Soysal, <i>HWHT</i> , 68'de bahsedilmiş ve kelimeleri eserde kullanılmıştır. |
| Nr. 235 | 44 | AnAr 10610 (CTH 738; <i>Konkordanz</i> : CTH 650). 3,0 × 3,9 cm. Daha Laroche, CTH Premier supplément'de Nr. 738.5 altına alınmıştır. <i>Zintuḫi</i> kadınlarının söylediği Hattice <i>taššaninna</i> şarkısını |

Katalog

| Tablet | Levha | Tanımlama |
|---------|-------|---|
| | | içerir; 2'-6'. satırlar KBo 19.163 I 9'-11', KBo 21.95 I 8'-10', KBo 21.96:7'-10', KBo 21.100 öy. 11'-13', KBo 21.102 ay. 10'-12', KBo 21.106 öy. 9'-12', KBo 44.136 öy. ⁷ 12'-15'e paraleldir. |
| Nr. 236 | 44 | AnAr 12175 (CTH 745). 2,6 × 3,7 cm. Hattice. Bkz. Akdoğan-Soysal, <i>AMMY</i> 2002, 184-85. Soysal, <i>HWHT</i> , 68'de bahsedilmiş ve kelimeleri eserde kullanılmıştır. |
| Nr. 237 | 44 | AnAr 11502 b (CTH 758). 3,6 × 3,0 cm. "Puriyanni Rituali". 1'-3'. satırlar için krş. KUB 35.54 III 3-5. |
| Nr. 238 | 44 | AnAr 8918 (CTH 760). 3,9 × 2,9 cm. "MUNUSŠU.GI Rituali". 1'-5'. satırlar için krş. KUB 9.34 I 30'-33', IV 8'-12', IBoT 3.102:8'-13' ve KBo 24.3 I 9-12. |
| Nr. 239 | 45 | AnAr 11621 d+g (CTH 760). 3,8 × 2,5 cm. 2'-3'. satırlar için bk. KUB 35.59 + KBo 29.13 II 4'-5' (CTH 760 II 3). |
| Nr. 240 | 45 | AnAr 14917 (CTH 760 ?). 6,4 × 4,1 cm. St. 3' ve 6'da ŠA ^d Pann[unta ŠAḤ.TUR] anılmaktadır; krş. KUB 9.4 III 22', 25', IV (21'), (29')-30' ve KBo 29.196 ay. ⁷ 3'. |
| Nr. 241 | 45 | AnAr 14839 a (CTH 763). 6,1 × 3,8 cm. Luvice pasajlar içeren ritual. |
| Nr. 242 | 45 | AnAr 14914 (CTH 763). 4,5 × 3,2 cm. Herhalde ritual ve öy. 7'-8'. satırlarda Luvice içeriyor; st. 6'-7' için krş. KUB 32.70 sağ. sü. 4'-5' (CTH 763). Benzer içerikli pasajlar ise şunlardır: KUB 17.15 II 9' vdd. (CTH 767.2.C), KUB 9.4 III 42' (CTH 760.I.2), KUB 35.145 öy. 3'-4' (CTH 767.2.A). |
| Nr. 243 | 46 | AnAr 9251 (CTH 764.I). 7,5 × 5,8 cm. Mitoloji ve büyü. Orta Hitit yazısı ile yazılmıştır. Metin çalışması için bkz. Akdoğan, FsKoşak'da, 1-12. Öy. 10' için krş. KBo 12.89 III 9'-10'. |
| Nr. 244 | 46 | AnAr 12170 (CTH 767). 4,8 × 3,0 cm. Luvice etkisindeki büyü metni. 3'-9'. satırlar KUB 35.143:4'-12' (CTH 767.2.B)'ye duplikat ya da paraleldir. |
| Nr. 245 | 46 | AnAr 10319 (CTH 780). 4,8 × 3,2 cm. "Allaituraḫi Rituali". 2'-9'. satırlar VS 28.57 IV 5'-12'ye duplikattır. |
| Nr. 246 | 46 | AnAr 12131 c (CTH 788 ?). 3,3 × 6,2 cm. "Šalašu Rituali"ni andırmaktadır. |
| Nr. 247 | 46 | AnAr 42-2-66 (CTH 789). 3,5 × 3,9 cm. Hurrice "Serbest Bırakma Şarkısı"na ait Hititçe fragman. Öy. 2': ^m Me-ge-e[š]. 5'. satırdaki "da" işaretine göre Yeni Hititçe yazı karakteri gösteriyor; krş. KBo 57.180 ve bununla ilgili yorumlar: J. L. Miller, KBo 57, s. IX-X. |
| Nr. 248 | 47 | AnAr 14918 (CTH 790). 5,4 × 4,9 cm. Hurrice içeren ritual. 4'. satır için krş. KBo 11.19 öy. 13' (CTH 788.2.A). |
| Nr. 249 | 47 | AnAr 10318 (CTH 791; <i>Konkordanz</i> : CTH 370.II). 4,7 × 3,8 cm. Hurrice. Öy. II ² 4'-5'. satırlar KUB 47.17:2'-3'e paraleldir. Laroche, <i>GLH</i> 1, 144'de <i>gešhena</i> kelimesi altında site edilmiş, transkripsiyonu da Salvini-Wegner tarafından ChS I/6, 53'de (Nr. 22) verilmiştir. |
| Nr. 250 | 47 | AnAr 10595 (CTH 791). 4,9 × 4,5 cm. Hurrice. Kelimeleri Laroche, <i>GLH</i> 'ye alınmış, transkripsiyonu da Trémouille tarafından ChS I/8, 84'de (Nr. 163) verilmiştir. |
| Nr. 251 | 47 | AnAr 11616 a (CTH 791). 2,9 × 2,6 cm. Hurrice, ancak metin türü belli değil. |
| Nr. 252 | 47 | AnAr 12155 (CTH 791). 7,4 × 8,3 cm. Hurrice. Metin çalışması için bkz. Akdoğan-Wilhelm, <i>AMMY</i> 2001, 246-47 ve <i>ZA</i> 93, 227-30; ayrıca krş. Trémouille, ChS I/8, 16 (Nr. 19). |

Sumer-Akkad Edebî Eserleri (CTH 792-819 "Littérature Suméro-Akkadienne")

- Nr. 253 48 AnAr 8915 (CTH 819). 8,0 × 5,3 cm. Akkadça. Metin olarak krş. ABoT II 262 (AnAr 11619 c+e); ancak bunlar farklı tabletlerdir.
- Nr. 254 48 AnAr 8917 (CTH 819). 4,5 × 5,2 cm. Tarihsel konulu olabilir; böylece Akkadça bir antlaşma ya da mektup (CTH 208 ya da 216 ?).

Katalog

| Tablet | Levha | Tanımlama |
|--------|-------|-----------|
|--------|-------|-----------|

Nr. 255 48 AnAr 9167 (CTH 819). 7,5 × 7,4 cm. Sumerce.

Nr. 256 48 AnAr 10321 (CTH 819). 3,4 × 3,3 cm. Akkadça omina / kehanet metni ?

Değişik Konular, Dili ve Türü Saptanamayan Metinler (CTH 820–833 “Varia”)

Nr. 257 48 AnAr 8360 d (CTH 831). 2,1 × 3,0 cm. Hititçe değil, herhalde Hurrice.

Nr. 258 49 AnAr 10873 (CTH 831). 4,4 × 7,1 cm. Hititçe değil. *Düzeltilme eki*: G. Beckman’a göre (şifahen) Sumerce bölüm başlıklı (KA.INIM.MA) Akkadça büyü; bu durumda daha çok CTH 819.

Nr. 259 49 AnAr 11246 ı (CTH 831). 3,4 × 4,0 cm. Hititçe olmayan bir dil.

Nr. 260 49 AnAr 11617b (CTH 831). 3,9 × 4,1 cm. Herhalde Hititçe değil.

Nr. 261 49 AnAr 11616 c (CTH 831). 3,4 × 2,9 cm. Hurrice ya da Hattice ?

Nr. 262 49 AnAr 11619 c+e (CTH 831). 4,3 × 2,1 cm. Hititçe değil, herhalde Akkadça. ABoT II 253 (AnAr 8915)’deki kompozisyona ait olabilir.

Nr. 263 49 AnAr 14935 (CTH 831). 3,5 × 2,0 cm. Herhalde Hurrice.

Nr. 264 49 AnAr 6966 (CTH 832). 4,4 × 5,7 cm.

Nr. 265 50 AnAr 6968 (CTH 832). 2,8 × 2,9 cm. St. 3’: *a-ap-^lpa^l*.

Nr. 266 50 AnAr 6988 (CTH 832). 2,2 × 3,0 cm.

Nr. 267 50 AnAr 6996 (CTH 832). 2,9 × 1,8 cm. Herhalde dinsel konulu. St. 5’: [*IŠ*]-*TU*^{URU}].

Nr. 268 50 AnAr 7002 (CTH 832). 4,9 × 6,0 cm.

Nr. 269 50 AnAr 7004 (CTH 832). 2,2 × 3,0 cm.

Nr. 270 50 AnAr 8354 (CTH 832). 6,4 × 4,0 cm.

Nr. 271 50 AnAr 8355 (CTH 832). 7,6 × 5,4 cm. Omina / kehanet metni ?

Nr. 272 51 AnAr 8358 c (CTH 832). 1,9 × 1,8 cm.

Nr. 273 51 AnAr 8360 b (CTH 832). 5,7 × 3,0 cm.

Nr. 274 51 AnAr 8360 ç (CTH 832). 2,5 × 2,1 cm. Sol sütuna ait yukarı doğru kavisli tek satır eğer [*ma*]-*al-di* okunacak ise, dinsel konulu olacaktır.

Nr. 275 51 AnAr 8360 e (CTH 832). 2,8 × 2,5 cm. Bkz. R. Akdoğan, *AMMY* 2005, 202, 216.

Nr. 276 51 AnAr 8360 g (CTH 832). 1,7 × 2,5 cm.

Nr. 277 51 AnAr 8360 j (CTH 832). 2,1 × 2,1 cm. St. 1’: [*p*]*é-^len-na^l-[i[?]*].

Nr. 278 51 AnAr 8360 k (CTH 832). 1,5 × 2,5 cm. Rüya ve adak (CTH 584, 590) ya da fal metni (CTH 577–579). St. 2’: MUNUS.L[UGAL]; 3’: AŠ^{URU}*Kum-[ma-an-ni(?)]*.

Nr. 279 51 AnAr 8360 r (CTH 832). 3,2 × 2,5 cm. Tarihsel içerikli olabilir; mektup ya da antlaşma ? St. 4’: [E]N-KA-*ma*.

Nr. 280 51 AnAr 8364 (CTH 832). 6,1 × 5,2 cm.

Nr. 281 52 AnAr 8365 a (CTH 832). 2,8 × 2,5 cm. Tarihsel içerikli olabilir. St. 2’: [*l*]*i-in-kir*; 5’: GİŠ^{URU}TUKUL.GÍ[D. DA].

Nr. 282 52 AnAr 8365 ç (CTH 832). 2,7 × 1,8 cm.

Nr. 283 52 AnAr 8365 ğ (CTH 832). 2,4 × 1,6 cm. St. 3’: MUNUS.LUGA[L].

Nr. 284 52 AnAr 8844 a (CTH 832). 2,3 × 2,3 cm. St. 4’ herhalde ^{URU}*Kum[manni]* olarak tamamlanacaktır. Fragmanın yazısı ABoT II 285 (AnAr 8844 c) ile aynı; böylece herhalde aynı tablete aitler.

Katalog

| Tablet | Levha | Tanımlama |
|---------|-------|---|
| Nr. 285 | 52 | AnAr 8844 c (CTH 832). 1,4 × 1,9 cm. Belki de envanter metni. St. 1': KISLAḪ LUGAL ? ABoT II 284 (AnAr 8844 a) ile aynı tablete ait olabilir. |
| Nr. 286 | 52 | AnAr 8845 (CTH 832). 4,4 × 3,0 cm. |
| Nr. 287 | 52 | AnAr 8846 (CTH 832). 3,4 × 4,6 cm. |
| Nr. 288 | 52 | AnAr 8850 (CTH 832). 2,1 × 2,6 cm. St. 1': É-ḫir-za-ma ¹ . |
| Nr. 289 | 52 | AnAr 8852 (CTH 832). 3,3 × 3,1 cm. |
| Nr. 290 | 52 | AnAr 8853 (CTH 832). 2,4 × 2,2 cm. |
| Nr. 291 | 52 | AnAr 8856 (CTH 832). 3,6 × 5,6 cm. |
| Nr. 292 | 53 | AnAr 8913 (CTH 832; <i>Konkordanz</i> : CTH 215.?). 4,0 × 2,4 cm. Bkz. Akdoğan, <i>AMMY</i> 2005, 202–04, 217. |
| Nr. 293 | 53 | AnAr 8920 (CTH 832). 5,5 × 3,6 cm. |
| Nr. 294 | 53 | AnAr 8921 (CTH 832). 2,9 × 2,0 cm. |
| Nr. 295 | 53 | AnAr 8922 (CTH 832). 4,8 × 3,2 cm. |
| Nr. 296 | 53 | AnAr 9143 (CTH 832). 5,3 × 4,1 cm. |
| Nr. 297 | 53 | AnAr 9144 (CTH 832). 4,9 × 6,7 cm. |
| Nr. 298 | 53 | AnAr 9460 (CTH 832). 2,5 × 2,4 cm. Herhalde dinsel konulu. |
| Nr. 299 | 54 | AnAr 9461 (CTH 832). 2,3 × 2,4 cm. |
| Nr. 300 | 54 | AnAr 9462 (CTH 832). 3,2 × 1,9 cm. Akkadça. Olası bir Hitit-Mısır mektuplaşması (CTH 170 ?). 5'–6'. satırlardaki <i>ša-ni-e</i> ve <i>a-ḫi-ia</i> kelimeleri için krş. KUB 3.69 ay. 6 (<i>ša-ni-i</i>), 8 (<i>ŠEŠ-ia</i>); bkz. Edel, <i>ÄHK</i> I, 90. |
| Nr. 301 | 54 | AnAr 9463 (CTH 832). 1,8 × 2,9 cm. |
| Nr. 302 | 54 | AnAr 9467 (CTH 832). 3,7 × 2,0 cm. |
| Nr. 303 | 54 | AnAr 9470 (CTH 832). 2,3 × 4,5 cm. Herhalde dinsel konulu. 4'. satırdaki GE ₆ -ti-ma yazımı için krş. KUB 33.102 II 13'deki GE ₆ -KAM-ti-ia. |
| Nr. 304 | 54 | AnAr 9718 (CTH 832). 3,7 × 2,3 cm. |
| Nr. 305 | 54 | AnAr 9719 (CTH 832). 3,8 × 2,0 cm. Bir tabletin kolofon kısmı. St. 3': INIM ḫ ¹ [...]. |
| Nr. 306 | 54 | AnAr 9728 (CTH 832). 4,6 × 3,9 cm. 4'. satırda geçen Akkadça <i>IKRŪB</i> kelimesi nedeniyle bir rüya ve adak metni olabilir (CTH 590 ?). |
| Nr. 307 | 54 | AnAr 9729 (CTH 832). 2,8 × 2,3 cm. |
| Nr. 308 | 55 | AnAr 9731 (CTH 832). 4,0 × 4,7 cm. Herhalde dinsel konulu. |
| Nr. 309 | 55 | AnAr 9732 (CTH 832). 2,1 × 2,9 cm. |
| Nr. 310 | 55 | AnAr 10314 (CTH 832). 4,4 × 4,5 cm. St. 2': [LUGAL ²]-u-iz-zi-ia[...]; 5': [m...]-li-in-na LUGAL-iz-ni "ve [...]li'yi krallığa [...]". |
| Nr. 311 | 55 | AnAr 10316 (CTH 832). 3,4 × 3,9 cm. Ritual ya da tıbbî metin ? |
| Nr. 312 | 55 | AnAr 10317 (CTH 832). 3,4 × 4,0 cm. 4'. satırda bir ^m <i>Muršili</i> anmaktadır ve tarihsel içerikli olabilir; antlaşma ya da protokol (CTH 212, 275) ? |
| Nr. 313 | 55 | AnAr 10323 (CTH 832). 4,0 × 2,5 cm. |
| Nr. 314 | 55 | AnAr 10324 (CTH 832). 2,3 × 2,6 cm. St. 4' belki de [DINGIR.M]EŠ ŠA <KUR> <i>Kar-an-d[u-ni-ia]</i> okunacaktır. |
| Nr. 315 | 55 | AnAr 10601 a (CTH 832). 3,5 × 2,0 cm. |

Katalog

| Tablet | Levha | Tanımlama |
|---------|-------|--|
| Nr. 316 | 55 | AnAr 10601 b (CTH 832). 3,2 × 2,6 cm. |
| Nr. 317 | 56 | AnAr 10607 (CTH 832). 4,5 × 3,1 cm. Enstrüksiyon ya da dua ? |
| Nr. 318 | 56 | AnAr 10608 (CTH 832). 3,0 × 3,2 cm. “KIN” falı ya da bir rituale ait büyü sözleri ? |
| Nr. 319 | 56 | AnAr 10759 (CTH 832). 7,4 × 6,6 cm. Eski Hitit yazısı karakterleri göstermektedir. Öy. 2': [ut-n]i-ja-an-ta-an. |
| Nr. 320 | 56 | AnAr 11240 a (CTH 832). 2,3 × 2,1 cm. St. 2': [š]u-up-pí-iš. |
| Nr. 321 | 56 | AnAr 11240 b (CTH 832). 3,1 × 2,4 cm. |
| Nr. 322 | 56 | AnAr 11246 f (CTH 832). 1,6 × 1,9 cm. Özensiz [?] yazısı nedeniyle fal metni olabilir. |
| Nr. 323 | 57 | AnAr 11246 i (CTH 832). 3,1 × 3,4 cm. St. 4': [h]u-i-nu-mi; 6': [š]u-un- ^l na-an-z ^l [i]. |
| Nr. 324 | 57 | AnAr 11385 a (CTH 832). 4,8 × 2,8 cm. G. Beckman'a göre (şifahen) büyü içeren bir ritual. |
| Nr. 325 | 57 | AnAr 11390 (CTH 832). 2,3 × 3,0 cm. |
| Nr. 326 | 57 | AnAr 11392 (CTH 832). 3 × 3 cm. Dinsel konulu olabilir. |
| Nr. 327 | 57 | AnAr 11393 (CTH 832). 2,4 × 3,9 cm. |
| Nr. 328 | 57 | AnAr 11404 (CTH 832). 2,5 × 2,2 cm. Dua ya da adak ? St. 1': [ne-p] ^l i-š ^l a-aš ^l [^d l[...]. |
| Nr. 329 | 57 | AnAr 11500 (CTH 832). 5,2 × 4,9 cm. Tekrarlanan maddeler içermektedir. St. 7': pé-eš-š[i-ja-az ² -zi]. |
| Nr. 330 | 57 | AnAr 11617 a (CTH 832). 5,5 × 4,4 cm. |
| Nr. 331 | 58 | AnAr 11621e (CTH 832). 3,0 × 2,2 cm. |
| Nr. 332 | 58 | AnAr 12131 g (CTH 832). 2,8 × 1,5 cm. |
| Nr. 333 | 58 | AnAr 12163 (CTH 832 ya da 212, 275; <i>Konkordanz</i> : CTH 470). 3,0 × 4,5 cm. Tarihsel içerikli ya da daha çok enstrüksiyon / protokol ? Metin için bkz. Akdoğan, <i>AMMY</i> 2005, 197–98. |
| Nr. 334 | 58 | AnAr 12180 (CTH 832). 2,0 × 1,4 cm. |
| Nr. 335 | 58 | AnAr 12181 (CTH 832). 4,0 × 2,7 cm. |
| Nr. 336 | 58 | AnAr 12182 (CTH 832). 5 × 3 cm. |
| Nr. 337 | 58 | AnAr 12189 (CTH 832). 2,5 × 3,5 cm. |
| Nr. 338 | 58 | AnAr 12196 (CTH 832). 2 × 2 cm. Envanter metni ? |
| Nr. 339 | 58 | AnAr 12197 (CTH 832). 2,6 × 3,3 cm. Bayram tasviri ? St. 3': kar-š[a-an-zi]; 5': ku-in. |
| Nr. 340 | 59 | AnAr 14455 (CTH 832). 2,3 × 1,8 cm. St. 2': KI-LI-LI ^[HIA] ? |
| Nr. 341 | 59 | AnAr 14924 (CTH 832). 3,0 × 3,3 cm. |
| Nr. 342 | 59 | AnAr 14925 (CTH 832). 5,4 × 4,3 cm. Tarihsel ya da idarî konulu bir metin ? |
| Nr. 343 | 59 | AnAr 14929 (CTH 832). 4,6 × 3,4 cm. |
| Nr. 344 | 59 | AnAr 14930 (CTH 832). 4,9 × 4,9 cm. St. 3': [t]u-el É-KA. |
| Nr. 345 | 59 | AnAr 14937 (CTH 832). 3,7 × 3,5 cm. |
| Nr. 346 | 59 | AnAr 14938 (CTH 832). 3,2 × 1,9 cm. St. 6': İ-it. |
| Nr. 347 | 60 | AnAr 14941 (CTH 832). 2,8 × 2,1 cm. |
| Nr. 348 | 60 | AnAr 14944 (CTH 832). 4,9 × 2,0 cm. Tarihsel konulu olmalıdır. Ay.'deki çift paragraf çizgisinden sonra başlayan satır eğer [... LUGAL.GA]L LUGAL KU[R ^{URU} ...] okunacak ise, bir kral ismi de içeren giriş kısmı olabilir. |
| Nr. 349 | 60 | AnAr 14947 (CTH 832). 2,3 × 2,2 cm. St. 2': GEŠTIN.SIG ₅ . |

Katalog

| Tablet | Levha | Tanımlama |
|---------|-------|---|
| Nr. 350 | 60 | AnAr 14954 (CTH 832). 2,8 × 2,4 cm. Dinsel konulu olabilir. |
| Nr. 351 | 60 | AnAr 14957 (CTH 832). 2,4 × 3,1 cm. |
| Nr. 352 | 60 | AnAr 14964 (CTH 832). 2,8 × 2,5 cm. |
| Nr. 353 | 60 | AnAr 14968 (CTH 832; <i>Konkordanz</i> : CTH 238 ?). 2,5 × 3,1 cm. Bkz. Akdoğan, <i>AMMY</i> 2005, 199. Şehir adları sayılmaktadır. 5'. satırdaki ^{URU} Šanap[ra?] KUB 26.43 öy. 26 (CTH 225.A)'da da geçer. |
| Nr. 354 | 60 | AnAr 14969 (CTH 832). 4,4 × 2,2 cm. Dinsel konulu olabilir; ritual ? |
| Nr. 355 | 61 | AnAr 14974 (CTH 832). 2,8 × 2,1 cm. |
| Nr. 356 | 61 | AnAr 14975 (CTH 832). 2,3 × 1,9 cm. |
| Nr. 357 | 61 | AnAr 14978 (CTH 832). 4,5 × 3,5 cm. Dinsel konulu. 10'. satırda [nu]-ut-ták-kán 2. şahısa seslenişi işaret etmektedir. |
| Nr. 358 | 61 | AnAr 14981 (CTH 832). 3,3 × 2,0 cm. |
| Nr. 359 | 61 | AnAr 14982 (CTH 832). 3,6 × 1,7 cm. |
| Nr. 360 | 61 | AnAr 14983 (CTH 832). 2,9 × 3,5 cm. Sıkça 2. şahıs (tekil ve çoğul) emir kipi içermektedir; enstrüksiyon, antlaşma ya da protokol ? |
| Nr. 361 | 61 | AnAr 15154 (CTH 832). 3,8 × 4,4 cm. Görünüşe göre uzun bir deri / post listesi; böylece bir envanter metni olabilir. Krş. KUB 60.29 öy. 7'-11' (CTH 250). |
| Nr. 362 | 61 | AnAr 15156 (CTH 832). 3,7 × 3,0 cm. |
| Nr. 363 | 62 | AnAr 15159 (CTH 832). 3,2 × 2,8 cm. Korunduğu kadarıyla Orta Hitit yazısı özellikleri göstermektedir. |
| Nr. 364 | 62 | AnAr 15161 (CTH 832). 2,8 × 2,2 cm. |
| Nr. 365 | 62 | AnAr 21624 (CTH 832). 4,2 × 2,6 cm. |
| Nr. 366 | 62 | AnAr 21625 (CTH 832). 2,2 × 2,7 cm. |
| Nr. 367 | 62 | AnAr 21720 (CTH 832). 5,4 × 3,1 cm. |
| Nr. 368 | 62 | AnAr 21721 (CTH 832). 2,6 × 2,1 cm. Herhalde dinsel konulu. |
| Nr. 369 | 62 | AnAr 21731 (CTH 832). 2,4 × 2,0 cm. |
| Nr. 370 | 62 | AnAr 21733 (CTH 832). 3,9 × 2,0 cm. |
| Nr. 371 | 62 | AnAr 21740 (CTH 832). 2,4 × 2,1 cm. Envanter metni ? |
| Nr. 372 | 62 | AnAr 21766 (CTH 832). 3,7 × 3,1 cm. |
| Nr. 373 | 63 | AnAr 21771 (CTH 832). 2,7 × 2,4 cm. |
| Nr. 374 | 63 | AnAr 21829 (CTH 832). 4,5 × 2,6 cm. |
| Nr. 375 | 63 | AnAr 4220 b (CTH 832). 2,9 × 2,8 cm. |
| Nr. 376 | 63 | AnAr 4220 c (CTH 832). 2,7 × 3,6 cm. |
| Nr. 377 | 63 | AnAr 4220 h (CTH 832). 2,2 × 2,6 cm. |
| Nr. 378 | 63 | AnAr 4220 k (CTH 832). 2,2 × 2,0 cm. |
| Nr. 379 | 63 | AnAr 4220 ö (CTH 832). 2,8 × 2,4 cm. |
| Nr. 380 | 63 | AnAr 68-3-65 (CTH 832). 2,6 × 2,6 cm. |
| Nr. 381 | 63 | AnAr 28-2-66 (CTH 832). 3,2 × 3,6 cm. |
| Nr. 382 | 63 | AnAr 26-2-68 (CTH 832). 4,6 × 4,4 cm. Dinsel konulu. |
| Nr. 383 | 64 | AnAr 26-3-68 (CTH 832). 4,7 × 3,0 cm. |

Katalog

| <i>Tablet</i> | <i>Levha</i> | <i>Tanımlama</i> |
|----------------|--------------|--|
| Nr. 384 | 64 | AnAr 90-5-68 (CTH 832). 2,3 × 4,1 cm. |
| Nr. 385 | 64 | AnAr 90-7-68 (CTH 832). 2,3 × 3,0 cm. |
| Nr. 386 | 64 | AnAr 80-2-74 (CTH 832 ya da 500). 2,8 × 2,7 cm. Dinsel konulu. St. 2'de [^d Minki]n ve ^d Amu[nkin] anılıyor ve bu nedenle Kizzuwatna kaynaklı bir ritual olabilir. |
| Nr. 387 | 64 | AnAr 80-3-74 (CTH 832). 3,1 × 3,2 cm. |
| Nr. 388 | 64 | AnAr 96-3-76 (CTH 832). 3,1 × 2,5 cm. “Kuşsaray” tabletlerinden. |
| Nr. 389 | 64 | AnAr 96-4-76 (CTH 832). 4,2 × 1,4 cm. “Kuşsaray” tabletlerinden. |
| Nr. 390 | 64 | AnAr 96-5-76 (CTH 832). 3,8 × 2,0 cm. “Kuşsaray” tabletlerinden. 7'. satırda [^m H]ešni ve ^m Piḫa-A.[A] anar. |

CATALOG

The second volume presented here (ABoT II) is the continuation of the cuneiform edition *Ankara Arkeoloji Müzesinde Bulunan Boğazköy Tabletleri* (ABoT) published by Kemal Balkan in 1948. The Hittite tablets, which were acquired by the Ankara Anadolu Medeniyetleri Müzesi by purchase and donations, or came as surface finds, bear the siglum “AnAr.” The best-preserved and interesting ones among these tablets have been made accessible to the scholarly public through the publication of ABoT, the others, however, were not considered for publication at that time. Since the series of ABoT was later discontinued, such fragments, mostly still useful and in reasonable condition, remained untouched in the Ankara Museum for years.

When my colleague Rukiye Akdoğan decided to make copies of nearly four hundred AnAr fragments and publish them as ABoT II, an agreement of cooperation for the preparation of the catalog of this work was made in 2005. Although the cuneiform copies in other similar works like ABoT and IBoT I–IV were made by Turkish scholars (K. Balkan, M. Çiğ, H. Kızılyay, and M. Eren), the support of foreign scholars (H. G. Güterbock and H. A. Hoffner) was still sought for the catalogs. ABoT II, on the other hand, is a fully Turkish cuneiform edition as a welcome result of a joint Ankara-Chicago effort.

The small size of most of the fragments made it particularly difficult to determine the text genres and to place them in the text categories assigned in E. Laroche’s *Catalogue des textes hittites* (CTH). Nevertheless, after two years of intensive work and with the support of the Chicago Hittite Dictionary Project’s lexical files, it has been possible to find many duplicates of well-known compositions from Boğazköy. We believe this volume will certainly enrich the Hittite text corpus.

With the present edition of 389 hand copies and photographs of one other tablet, almost no other AnAr fragments in the Ankara Museum would be worth publishing. The following information concerns five AnAr texts, whose hand copies are not included in ABoT II:

- 1) AnAr 8655 (CTH 209). This fragment, which is cited in Košak’s *Konkordanz* as CTH 832, was actually edited as ABoT 64, where, however, its inventory number is given differently as Al/D 164 (Alaca Höyük).
- 2) AnAr 10285 (ABoT II 140). A large part of the surface of this fragment is heavily abraded and unreadable, so a hand copy would not be worthwhile. Photographs of the tablet are given here instead (pl. 27).
- 3) AnAr 10590 (CTH 188). This Middle Hittite letter was recently studied by B. Dinçol in *SMEA* 49, 235–45, where a photograph and hand copy of the tablet are provided as well.
- 4) AnAr 10605 (CTH 540.I.4). Birth omina. This fragment is treated by K. K. Riemschneider (StBoT 9, 9 n. 1) who also provides a hand copy on Textbeilage II; cf. also Riemschneider, DBH 12, 159.
- 5) AnAr 10753 (CTH 540.II.6). Birth omina. Already listed by E. Laroche in CTH Premier supplément, under nr. 540. This fragment is treated by K. K. Riemschneider in StBoT 9, 39ff., who also provides a hand copy on Textbeilage II; cf. also Riemschneider, DBH 12, 159. According to the inventory records of the Ankara Museum, the origin of the tablet is Emirbaşı Köyü.

While this volume was in preparation, the transliterations of the hand copies herein were published by Rukiye Akdoğan separately in DBH 32. In that volume additional joins are noted, but it was too late in the publication process to be considered here. Thus, due to the different transliterations used by both authors, one may also notice slight differences between the two publications, especially in the readings of proper names.

I would like to express my sincere thanks to the Hittite Dictionary Project of the Oriental Institute of the University of Chicago for allowing me to use the lexical files during my work on this catalog, and to the Oriental Institute for a generous financial grant in 2007 that made it possible for me to travel to Turkey and work in Ankara for two weeks. My longtime Chicago colleague Richard H. Beal read the English sections for corrections, and Gary Beckman (Ann Arbor) made some helpful suggestions regarding catalog details; let me thank them both for their kind help.

Oğuz Soysal
February 10, 2011
Chicago

Catalog

| Tablet | Plate | Description |
|--------|-------|-------------|
|--------|-------|-------------|

Historical Texts (CTH 1–216 “Textes Historiques”)

- Nr. 1** 1 AnAr 12194 (CTH 51.I.C). 4.0 × 2.4 cm. Akkadian Šattiwaza Treaty; belongs to the copy CTH 51.I.C, and obv. 45–55 are duplicates of KBo 1.1 obv. 43–51; see Akdoğan, *AMMY* 2005, 200–02.
- Nr. 2** 1 AnAr 4220 1 (CTH 53.E). 2.2 × 3.7 cm. Akkadian Tette Treaty; indirect join to KBo 28.98, and obv. 2'–6' are a duplicate of KBo 1.4 II 6–11.
- Nr. 3** 1 AnAr 11621 a (CTH 71.C). 4.8 × 3.9 cm. “Affair of ^{MUNUS}AMA.DINGIR-LIM”; lines 2'–10' are duplicates of KBo 4.8 II 17'–22' and III 1–3.
- Nr. 4** 1 AnAr 11386 (CTH 186?). 3.7 × 5.0 cm. In line 3 [LUGAL[?] KUR] *Kar-ga-miš* is mentioned. The text content is similar to the letter KBo 18.48 rev.; cf. there LUGAL^{KUR} *Kargamiš* and BAL-nu- in rev. 9'–10', 13'.
- Nr. 5** 1 AnAr 8916 (CTH 212 or 275). 7.0 × 4.8 cm. Due to the phrase *ištamaš- ... UL tekkušnu-* “to hear but conceal” (obv. 5'–6') perhaps a treaty or protocol.
- Nr. 6** 1 AnAr 14932 (CTH 216). 2.6 × 2.6 cm. Fragment of an Akkadian treaty. ^{LÚ.MEŠ}DAM.GÀR ŠA KUR [*Hatti*] (line 6') reminds one of KBo 1.4 II 2 (CTH 53.A).

Administrative and Technical Texts (CTH 221–287 “Textes Administratifs et Techniques”)

- Nr. 7** 2 AnAr 11401 (CTH 238?). 7.9 × 3.5 cm. List of city names.
- Nr. 8** 2 AnAr 9722 (CTH 239). 4.2 × 4.3 cm. Field text.
- Nr. 9** 2 AnAr 12928 (CTH 242). 5.4 × 5.4 cm. Glass production text. For the text, see Akdoğan-Wilhelm, *AMMY* 2001, 242–43, and ZA 93, 220–22.
- Nr. 10** 2 AnAr 12131 d (CTH 275?). 5.9 × 3.5 cm. Probably an instruction text; for the form *halziaši* in line 6', cf. KUB 26.12 III 23.
- Nr. 11** 2 AnAr 14921 (CTH 275?). 4.5 × 5.1 cm. Instruction?
- Nr. 12** 3 AnAr 9469 (CTH 276). 5.5 × 6.1 cm. Catalog tablet.
- Nr. 13** 3 AnAr 9134 (CTH 287). 5.6 × 4.7 cm. Horse training text; I[?] 4' [*IŠTU É* ^{LÚ}KUŠ₇ *p*] *arā uwadanzi* and I[?] 7' [... *gip*] *eššar arnuanzi*. The fragment exhibits Middle Hittite script.

Lexical Texts (CTH 299–316 “Textes Scolaires”)

- Nr. 14** 3 AnAr 15162 (CTH 309). 5.5 × 2.2 cm. Sumerian portion of a vocabulary text.
- Nr. 15** 3 AnAr 21630 (CTH 309). 4.8 × 3.9 cm. Hittite portion of a vocabulary text.

Mythological Texts (CTH 321–370 “Mythologie”)

- Nr. 16** 3 AnAr 80-1-74 (CTH 335?). 4.2 × 4.4 cm. Reminiscent of the soothing rituals for the angry god in the Telipinu Myth (CTH 324); see also line 8': [^d*Te-l*]-*pí-n*[*u*].
- Nr. 17** 4 AnAr 96-6-76 (CTH 348.27.B). 2.6 × 3.0 cm. Hedammu Myth. This fragment is one of the “Kuşsaray” tablets (others are ABoT II 143, 388–90; in general, see under Nr. 143). It was previously transliterated by H. G. Güterbock in KBo 26 on p. VII under nr. 109 with a tentative designation “Çorum 1” as a duplicate of KBo 26.79; see Groddek, *AoF* 25, 231 f. (nr. 44). It is remarkable that a composition of this kind (a myth of Hurrian origin) was really unearthed outside of Boğazköy.

Catalog

| <i>Tablet</i> | <i>Plate</i> | <i>Description</i> |
|---------------|--------------|---|
| Nr. 18 | 4 | AnAr 12165 (CTH 361.II). 4.9 × 6.6 cm. To the Hurrian Kešši Story. |
| Nr. 19 | 4 | AnAr 12164+ (CTH 362.A.1). 3.6 × 9.6 cm. Gurparanzaḫ Myth. Directly joins KUB 36.67 III 12'ff. For the text, see Akdoğan, <i>SMEA</i> 49, 1–20. |
| Nr. 20 | 4 | AnAr 10869 (CTH 370). 4.5 × 5.7 cm. A mythological text from the Hurrian ² milieu; obv. 2'–7' contain dialogues mentioning the Storm God and Ištar. On the co-occurrence of these deities, see KUB 33.92 IV 12'–14', KUB 33.113 I 16'–22' (Song of Ullikummi). |

Hymns and Prayers (CTH 371–389 “Hymnes et Prières”)

| | | |
|--------|---|--|
| Nr. 21 | 4 | AnAr 11621c (CTH 376.II.K). 4.0 × 2.8 cm. The prayer of Muršili II to the Sun Goddess of Arinna; lines 1'–8' are duplicate of KUB 24.3 III 11'–18'. |
| Nr. 22 | 4 | AnAr 11398 (CTH 378.II.D). 3.7 × 3.3 cm. The second Plague Prayer of Muršili II; lines 2'–8' are duplicate of KUB 14.11 III 17'–23'. |
| Nr. 23 | 5 | AnAr 12177 (CTH 378.?). 3.8 × 3.7 cm. One of the Plague Prayers of Muršili II; this fragment also contains a colophon indicating it is the “2 nd tablet,” but its alignment within the text group cannot be determined. |

Rituals (CTH 390–500 “Rituels”)

| | | |
|--------|---|--|
| Nr. 24 | 5 | AnAr 10591 (CTH 400). 6.2 × 6.2 cm. “Iriya Ritual”; obv. 6'–11' are duplicates of KUB 39.104 IV 1'–6'. |
| Nr. 25 | 5 | AnAr 12183 (CTH 402). 3.2 × 4.0 cm. “Malli Ritual”; lines 1'–6' are duplicates of KUB 24.9 II 7'–14'. |
| Nr. 26 | 5 | AnAr 14915 (CTH 404.5.II.A). 3.0 × 7.4 cm. Belongs to the same tablet as Bo 2738 (= KUB 58.79) without having a direct physical connection to it. |
| Nr. 27 | 6 | AnAr 12131 b (CTH 412?). 7.3 × 4.5 cm. Ritual/incantation speeches; similar to the Zuwi Ritual. The malicious entities listed in obv. 14'ff. are reminiscent of those in KBo 24.51 rev. ² 5'–7' and KBo 24.52:7. |
| Nr. 28 | 6 | AnAr 11613 a (CTH 430 or 470). 5.7 × 3.3 cm. Ritual/prayer to the Sun Goddess of the Earth, or a birth ritual; cf. KBo 17.60 rev. |
| Nr. 29 | 6 | AnAr 11246 a (CTH 446). 5.0 × 3.8 cm. Rev. ² 1'–11' are parallel to KUB 41.8 II 29'–37'. |
| Nr. 30 | 7 | AnAr 21626 + KBo 10.45 (CTH 446.B). 6.1 × 6.9 cm. Edited in Akdoğan-Wilhelm, <i>AMMY</i> 2001, 238–42 and <i>ZA</i> 93, 214–20. For KBo 53.34, a parallel text to AnAr 21626 + KBo 10.45 IV 37ff. and for others, see now J. L. Miller, KBo 53, p. V (under nr. 34). |
| Nr. 31 | 7 | AnAr 11503 a+d (CTH 448). 3.8 × 4.0 cm. Lines 1'–5' are parallel to KUB 60.161 II 7–10; cf. also KUB 17.18 II 26'ff. |
| Nr. 32 | 7 | AnAr 14966 (CTH 449 or 790). 4.3 × 2.2 cm. Obv. II ² 2'–7' are duplicates of KUB 58.88 II ¹ 4'–11'+ KUB 38.22 rev. 5'–8'. |
| Nr. 33 | 7 | AnAr 8926 (CTH 450?). 3.8 × 2.6 cm. Cf. KUB 39.8 + KBo 34.58 II 28'ff., KBo 25.184 II 18ff. |
| Nr. 34 | 7 | AnAr 4220 m (CTH 470?). 3.0 × 2.3 cm. For lines 4'–5', cf. KUB 7.60 II 13, 15 (CTH 423). |
| Nr. 35 | 7 | AnAr 4220 o + s (CTH 470). 4.1 × 4.1 cm. Ritual and myth? |
| Nr. 36 | 7 | AnAr 6993 (CTH 470?). 2.7 × 2.1 cm. Line 5 ^o : ŠI-PAT. |
| Nr. 37 | 8 | AnAr 8357 (CTH 470). 4.8 × 2.5 cm. Line 6': [pé]-e-da-an-z[i]. |

Catalog

| Tablet | Plate | Description |
|--------|-------|---|
| Nr. 38 | 8 | AnAr 9146 (CTH 470?). 3.5 × 1.9 cm. Perhaps a ritual fragment if in line 3' the word <i>himma-</i> is present. |
| Nr. 39 | 8 | AnAr 10308 (CTH 470?). 8.1 × 7.6 cm. Rev. 4' and 13': <i>ni-ni-ik?</i> Cf. KUB 59.26 IV 7'. |
| Nr. 40 | 8 | AnAr 10312 (CTH 470?). 5.5 × 5.5 cm. Rev. 3' and 8': DUMU- <i>an-na-aš hu-i-pa-at-ta-an</i> ; cf. KUB 12.58+ II 35': DUMU- <i>la-an-na-aš hu-i-pa-ia-ta-an</i> . |
| Nr. 41 | 8 | AnAr 10320 (CTH 470). 3.2 × 4.1 cm. [<i>idalu</i>] ^{š?} GISKIM- <i>iš</i> “[ba]d sign” is mentioned in line 5'; cf. KBo 13.101 I 27'–31' and rev. 19'–20' (CTH 435.2). |
| Nr. 42 | 9 | AnAr 10589 (CTH 470). 6.5 × 5.0 cm. Ritual/spell against evil tongues. |
| Nr. 43 | 9 | AnAr 10594 (CTH 470). 3.2 × 5.2 cm. Contains the ingredients list(?) of a ritual; for <i>šuppiyahh-</i> in line 4', see KBo 43.176 rev. 2'ff. and 6', similarly with an ingredients list. |
| Nr. 44 | 9 | AnAr 10602 (CTH 470). 3.1 × 3.8 cm. Line 3': [EN].SÍSKUR- <i>m[a]</i> ; 5': [<i>i</i>]- <i>ia-at-ta-[ri]</i> ? |
| Nr. 45 | 9 | AnAr 10868 (CTH 470). 6.5 × 3.8 cm. Lines 6'–15' are duplicates of KBo 24.10 obv. [?] I 3'–11'. |
| Nr. 46 | 9 | AnAr 11498 (CTH 470). 7.2 × 5.5 cm. Obv. [?] 4': <i>ha-ri-ia-az-[zi]</i> . |
| Nr. 47 | 10 | AnAr 11501 (CTH 470). 4.0 × 2.7 cm. |
| Nr. 48 | 10 | AnAr 11503 e (CTH 470?). 2.4 × 3.2 cm. Line 3': PA Š[E]; 4': <i>ša-mi-ši-ia-nu-z[i]</i> ; 5': [I]Š- [†] TU [†] KAŠ <i>šu-un-n[i-ia²-az²-zi]</i> . |
| Nr. 49 | 10 | AnAr 11503 g (CTH 470). 2.3 × 1.8 cm. For lines 3'–4', cf. KUB 43.60 I 21–22 (CTH 457.6). |
| Nr. 50 | 10 | AnAr 11620 b (CTH 470). 3.7 × 1.1 cm. Line 4': <i>iš-h[i-ia²-...]</i> . |
| Nr. 51 | 10 | AnAr 12171 (CTH 470). 7.0 × 6.1 cm. The phrase 2 ² /3 ² -ŠU 9 GÍŠGAG GÍŠMA.NU in obv. 10 reminds one of KUB 35.142 rev. [?] IV 21 (CTH 772.4). |
| Nr. 52 | 10 | AnAr 14916 (CTH 470). 4.2 × 4.0 cm. A magic ritual about the nailing down (i.e., deactivating) of evils; in lines 6'–7' the army of the king and the hostile [troops [?]] are mentioned. |
| Nr. 53 | 11 | AnAr 14989 (CTH 470). 1.7 × 2.0 cm. Ritual against the evil and sorcery? |
| Nr. 54 | 11 | AnAr 21813 (CTH 470?). 2.4 × 1.6 cm. |
| Nr. 55 | 11 | AnAr 64-1-65 (CTH 470). 4.6 × 4.2 cm. Obv. 9': DINGIR-LUM. |
| Nr. 56 | 11 | AnAr 14973 (CTH 470 or 448?). 1.7 × 2.2 cm. For <i>tarpalli-</i> in line 3', cf. AnAr 11503 a+d (ABoT II 31) lines (2'), 6', KUB 17.18 II 27, III (5), and KUB 60.161 II 5, 8 (all CTH 448). |
| Nr. 57 | 11 | AnAr 4220 r (CTH 470 or 530). 3.0 × 4.2 cm. Line 1': HÁD.D[U.A]; 2': BAPPIR. |
| Nr. 58 | 11 | AnAr 14951 (CTH 470 or 530). 3.1 × 3.0 cm. A list of ingredients for a ritual (or festival); cf. KBo 5.2 I 17ff. (CTH 424), KUB 7.20 obv. 7ff. (CTH 426), KUB 32.129 I 7, 9–10 (CTH 474), and KUB 32.133 I 11–13 (CTH 431). |
| Nr. 59 | 11 | AnAr 6992 (CTH 470 or 670). 4.3 × 3.3 cm. Ritual or festival description. |
| Nr. 60 | 12 | AnAr 8360 i (CTH 470 or 670). 2.5 × 3.4 cm. Rev. 2': [<i>d</i>] <i>a-m[†]e-e-d[†]la-ni pí-[di]</i> ; 4': [†] PA [†] -NI ^{NA} [[†] ZI.KIN]. |
| Nr. 61 | 12 | AnAr 8365 f (CTH 470 or 670). 1.8 × 2.5 cm. Line 1': GÍŠERIN- <i>ia</i>] or GÍŠERIN. [†] TUR [†] ? |
| Nr. 62 | 12 | AnAr 9138 (CTH 470 or 670). 3.8 × 3.5 cm. I ² 4': [<i>hur-</i> or <i>ú</i>]- <i>nu-ua-an</i> ; 7': [<i>p</i>] <i>i-ra-an</i> . |
| Nr. 63 | 12 | AnAr 9166 (CTH 470 or 670). 4.0 × 6.8 cm. Line 3': [†] <i>pé-e-d[†]la-a[n-zi]</i> . |
| Nr. 64 | 12 | AnAr 9465 (CTH 470 or 670). 2.9 × 3.6 cm. Lines 5'–6' may not be Hittite. Line 1': I UDU; 3': [†] É. [†] IA [†] ? |
| Nr. 65 | 12 | AnAr 9715 (CTH 470 or 670). 2.0 × 2.7 cm. Line 4': [... H]I.A <i>har-t[e-...]</i> . |

Catalog

| <i>Tablet</i> | <i>Plate</i> | <i>Description</i> |
|---------------|--------------|--|
| Nr. 66 | 12 | AnAr 10322 (CTH 470 or 670). 3.2 × 2.5 cm. |
| Nr. 67 | 13 | AnAr 10592 (CTH 470 or 670). 6.4 × 3.4 cm. Line 6': [me]-ma-al; 8': [s ⁱ]Gmi-ti-iš. |
| Nr. 68 | 13 | AnAr 10598 (CTH 470 or 670). 6.4 × 2.6 cm. Obv. [?] 6': [DU]G.KAŠ XII 'NINDA'.GU[R ₄ .RA.ḪI.A]. |
| Nr. 69 | 13 | AnAr 10603 (CTH 470 or 670). 2.8 × 3.1 cm. |
| Nr. 70 | 13 | AnAr 11246 d (CTH 470 or 670). 3.0 × 3.3 cm. Line 5': [ua]-ra-a-ni. |
| Nr. 71 | 13 | AnAr 11246 e (CTH 470 or 670). 3.3 × 2.0 cm. Line 2': "LXXX"; 4': KU ₆ .ḪI.A. |
| Nr. 72 | 13 | AnAr 11391 (CTH 470 or 670). 4.5 × 1.9 cm. Obv. [?] 4': a-aš-k[i] (photo). |
| Nr. 73 | 13 | AnAr 11396 (CTH 470 or 670). 1.5 × 3.7 cm. |
| Nr. 74 | 14 | AnAr 11614 a (CTH 470 or 670). 4.3 × 3.9 cm. Line 6': [d]a-pí-an ME-E. |
| Nr. 75 | 14 | AnAr 11616 b (CTH 470 or 670). 3.6 × 2.0 cm. Rev. [?] 5': i-ja-an-na-[i]. |
| Nr. 76 | 14 | AnAr 14453 (CTH 470 or 670). 5.6 × 6.8 cm. II [?] 7': nu-uš- ^l ma ^l -[aš]. |
| Nr. 77 | 14 | AnAr 12131 f (CTH 470 or 670). 2.9 × 3.0 cm. Line 2': [an-t]u ² -uh-ša-aš-š[a ²]. |
| Nr. 78 | 14 | AnAr 12131 h (CTH 470 or 670). 3.0 × 1.9 cm. |
| Nr. 79 | 14 | AnAr 12131 k (CTH 470 or 670). 1.7 × 2.2 cm. |
| Nr. 80 | 14 | AnAr 14931 (CTH 470 or 670). 2.1 × 4.1 cm. Line 4' is possibly not Hittite. |
| Nr. 81 | 15 | AnAr 14933 (CTH 470 or 670). 3.3 × 2.1 cm. The divine name ^d A-la-w[a-...] in line 6' belongs perhaps to ^d Alawayaimi; cf. KUB 30.56 III 18. |
| Nr. 82 | 15 | AnAr 14958 (CTH 470 or 670). 3.9 × 3.0 cm. |
| Nr. 83 | 15 | AnAr 14965 (CTH 470 or 670). 3.0 × 3.7 cm. Line 8': ^l a-ru ^l -um-ma-aš- ^l ša ^l (photo). |
| Nr. 84 | 15 | AnAr 14994 (CTH 470 or 670). 3.1 × 3.0 cm. For lines 5'–6', cf. KUB 56.55 I 12 (CTH 456). |
| Nr. 85 | 15 | AnAr 15155 (CTH 470 or 670). 4.0 × 4.3 cm. |
| Nr. 86 | 15 | AnAr 21631 (CTH 470 or 670). 3.2 × 3.4 cm. |
| Nr. 87 | 15 | AnAr 21730 (CTH 470 or 670). 2.3 × 2.3 cm. |
| Nr. 88 | 15 | AnAr 4220 e (CTH 470 or 670). 3.1 × 3.0 cm. |
| Nr. 89 | 16 | AnAr 28-1-66 (CTH 470 or 670). 4.2 × 2.9 cm. |
| Nr. 90 | 16 | AnAr 16-5-68 (CTH 470 or 670). 7.2 × 3.2 cm. In terms of context it resembles a Kizzuwatnan ritual (CTH 500). This fragment, alongside others (ABoT II 144, 214–17, 219–21, and 230), was purchased by D. Owen at Boğazköy in 1968 and donated to the Ankara Anadolu Medeniyetleri Müzesi. |
| Nr. 91 | 16 | AnAr 80-4-74 (CTH 470 or 670). 2.0 × 2.3 cm. Line 2': SILA ₄ .G[E ₆] (photo); 3': [^{MUNU}]skat-ri-iš-ša (cf. KUB 32.133 IV 2'). |
| Nr. 92 | 16 | AnAr 9464 (CTH 474.C). 5.7 × 6.2 cm. Listed in Laroche, CTH, p. 82. |
| Nr. 93 | 17 | AnAr 11618 (CTH 475). 4.9 × 3.4 cm. Lines 1'–9' are duplicates of KBo 9.119A I 9'–16' and Bo 69/630 obv. [?] rt. col. 4'–10'. |
| Nr. 94 | 17 | AnAr 6984 (CTH 500?). 4.3 × 4.6 cm. Probably a fragment of a Kizzuwatnan ritual; for line 3', cf. KBo 21.45 I 16'. |
| Nr. 95 | 17 | AnAr 6987 (CTH 500?). 3.7 × 3.6 cm. For lines 2'–6', cf. KBo 33.35 rev. [?] 6'–9' (CTH 790). |
| Nr. 96 | 17 | AnAr 7007 (CTH 500?). 3.5 × 4.8 cm. |

Catalog

| Tablet | Plate | Description |
|---------|-------|--|
| Nr. 97 | 17 | AnAr 8358 a+b (CTH 500?). 3.4 × 2.9 cm. |
| Nr. 98 | 17 | AnAr 8360 a (CTH 500?). 2.7 × 3.5 cm. |
| Nr. 99 | 17 | AnAr 8363 (CTH 500). 8.1 × 3.2 cm. For lines 13'–14', cf. KUB 29.7 rev. 47'–48' (CTH 480). |
| Nr. 100 | 17 | AnAr 8847 (CTH 500?). 3.0 × 2.0 cm. Line 1': [ki ² -i]š-ša-r ¹ [a-...]; 3': nu-uš-š[a-an]. |
| Nr. 101 | 18 | AnAr 9157 (CTH 500?). 11.8 × 2.7 cm. This fragment was directly joined by R. Akdoğan to KBo 41.114 (listed in the <i>Konkordanz</i> as CTH 832). It contains a list of animals and burned birds offered to Kizzuwatnan divinities; similar texts are ABoT 19 (CTH 706), KBo 33.169 (CTH 705), and KBo 2.18 (CTH 787.1). However, AnAr 9157 and ABoT 19 (= AnAr 9161) do not belong to the same tablet. |
| Nr. 102 | 18 | AnAr 10310 (CTH 500). 5.7 × 4.3 cm. II ² 9': I ŠU-Š[I]. |
| Nr. 103 | 18 | AnAr 10313 (CTH 500?). 4.5 × 4.5 cm. Obv. 3: da-[an-zi]; 6–7: I ^{DUG} kap-[pí-iš ...] / [k]a-ap-pa-ru-ma-aš ^{GI} [š ...] (cf. VBoT 89 I 12–13'). |
| Nr. 104 | 18 | AnAr 10587 (CTH 500). 4.0 × 5.3 cm. For lines 4'–5', cf. KBo 10.20 IV 2–3 (CTH 604.A). |
| Nr. 105 | 19 | AnAr 10865 (CTH 500?). 8.0 × 6.2 cm. A Kizzuwatnan ritual (CTH 790) or offering list for the Kizzuwatnan divinities (CTH 705). |
| Nr. 106 | 19 | AnAr 11246 g (CTH 500). 1.8 × 3.7 cm. Line 2' mentions ^d Kulitta. |
| Nr. 107 | 19 | AnAr 11388 (CTH 500). 2.6 × 3.5 cm. Line 1': [še-pí-i]t-ta ¹ ; 3': [ši-pa-a]n-ti. |
| Nr. 108 | 19 | AnAr 11408 (CTH 500?). 4.3 × 4.6 cm. |
| Nr. 109 | 19 | AnAr 11620 a (CTH 500). 3.7 × 3.7 cm. For line 3', cf. KUB 32.129 I 9. The unique form of the number “8” in this AnAr fragment (written as four broken verticals) is noticeable. |
| Nr. 110 | 19 | AnAr 14919 (CTH 500). 3.9 × 4.9 cm. For obv. 2–3, cf. IBoT 3.99:4'–5' and KUB 9.34 I [3']–4' (CTH 760). |
| Nr. 111 | 20 | AnAr 14955 (CTH 500). 2.7 × 1.9 cm. For lines 2'–4', cf. KBo 24.45 rev. 10–11 and KBo 27.202:5'–10' (CTH 479). |
| Nr. 112 | 20 | AnAr 90-4-68 (CTH 500). 2.0 × 4.3 cm. Line 3': [SÍG].SA ₅ ; 4': [A-NA] ¹ EN ¹ .SISKUR še-er ar-ḫa [ua-aḫ-nu-zi]. |
| Nr. 113 | 20 | AnAr 11615 (CTH 500 or 530). 3.2 × 2.8 cm. A Kizzuwatnan ritual or cult inventory. |
| Nr. 114 | 20 | AnAr 14922 (CTH 500 or 628?). 4.9 × 5.6 cm. A Kizzuwatnan ritual or festival; it may belong to the <i>Hišuwā</i> Festival. |

Cult Administration and Inventory Texts (CTH 501–530 “Administration Religieuse”)

| | | |
|---------|----|--|
| Nr. 115 | 20 | AnAr 6964 + 6991 (CTH 523?). 7.5 × 6.4 cm. List of provisions/ <i>MELQĒTU</i> ? For similar lists, see also KBo 11.36 IV 4–7 (CTH 523) and KUB 58.27 II 1–17 (CTH 635). |
| Nr. 116 | 20 | AnAr 10326 (CTH 530?). 2.7 × 1.7 cm. Cult inventory? |
| Nr. 117 | 21 | AnAr 10606 (CTH 530). 8.0 × 8.5 cm. Obv. 8': III ¹ DUG.KAŠ; 9': pé-e[š-kán-zi]; rev. 2': [LÚ.M]EŠ URU-LIM. |
| Nr. 118 | 21 | AnAr 10871 (CTH 530). 6.4 × 2.9 cm. Obv. 6': ma-al-li-iš-ká[n-zi]. |
| Nr. 119 | 22 | AnAr 11499 (CTH 530). 5.4 × 4.5 cm. In line 1' [^{UZU} H]A-KU-RA-TU ₄ is mentioned; cf. KBo 22.222 III (5') (CTH 530). |
| Nr. 120 | 22 | AnAr 14913 (CTH 530; <i>Konkordanz</i> : CTH 670). 8.3 × 3.7 cm. Cf. CTH 506, 525.3 and especially 511.1. The fragment is studied in Akdoğan-Soysal, <i>AMMY</i> 2002, 176–79. |

Catalog

| Tablet | Plate | Description |
|---------|-------|---|
| Nr. 121 | 22 | AnAr 3544 (CTH 530). 7.3 × 4.9 cm. Note the mention of the proper names ^d Šu-ú-i-ta and ^m Up-pa-ti-ši-pa (obv. 7'). For the divine name, see ^d Šu-ú-i-en-ta-an (KUB 57.102 IV? 4'). |
| Nr. 122 | 23 | AnAr 10315 (CTH 530 or 670). 3.4 × 4.3 cm. See Akdoğan, <i>AMMY</i> 2005, 199–200. |
| Nr. 123 | 23 | AnAr 11613 c (CTH 530 or 670). 4.5 × 5.2 cm. Possibly a festival description, a cult inventory or an oracle about a festival; for obv. 2', cf. ABoT 14 V 8' (CTH 568) and KUB 51.12 obv. 3 (CTH 670). See Akdoğan, <i>AMMY</i> 2005, 205–06, 220. |

Divination Texts (CTH 531–590 “Divination”)

| | | |
|---------|----|---|
| Nr. 124 | 23 | AnAr 14920 (CTH 538.I). 7.2 × 4.9 cm. Akkadian omen text; see Akdoğan-Soysal, <i>AMMY</i> 2002, 181–83. |
| Nr. 125 | 24 | AnAr 11407 (CTH 547.I). 8.6 × 11.6 cm. Akkadian liver model; cited in Riemschneider, <i>DBH</i> 12, 159. For line 1, see KBo 9.63 obv. A 2 and KBo 9.64 A 1. |
| Nr. 126 | 24 | AnAr 8357 b+c+d+e+g+h (CTH 560). 5.6 × 4.4 cm. Divination fragment of an undetermined type. The word <i>takku</i> in the protasis indicates an Old Hittite <i>Vorlage</i> . |
| Nr. 127 | 24 | AnAr 10609 (CTH 570). 4.7 × 2.7 cm. Lines 2'–12' are duplicates of KUB 5.6 III 24–38. |
| Nr. 128 | 25 | AnAr 10872 (CTH 570). 5.0 × 3.4 cm. “SU” oracle. Line 4': [EGIR-Š]Ú šu-ri<-iš> XII [ŠÀ TIR ...]; 6': [EGIR-Š]Ú; 9': ^{GIŠ} TUKUL ¹ . |
| Nr. 129 | 25 | AnAr 8357 a (CTH 572). 4.1 × 1.9 cm. “KIN” oracle. Line 6': [EGIR ² -p]a DU-u-e-ni (= <i>paiweni</i>). |
| Nr. 130 | 25 | AnAr 8840 (CTH 572?). 3.8 × 3.2 cm. Obv. 6': x x KI.GUB. |
| Nr. 131 | 25 | AnAr 9163 (CTH 572). 4.9 × 5.0 cm. III ² 4': da-p[í-an]; 6': H[U[L-lu]; IV ² 4': [mi-nu-m]ar ^{HIA} . |
| Nr. 132 | 25 | AnAr 11246 I (CTH 572?). 2.6 × 2.2 cm. |
| Nr. 133 | 25 | AnAr 11387 (CTH 572). 2.9 × 5.0 cm. |
| Nr. 134 | 25 | AnAr 12174 (CTH 572). 3.7 × 2.2 cm. |
| Nr. 135 | 25 | AnAr 12216 (CTH 572). 3.0 × 2.2 cm. Line 4': [d]a-pí-an Z[I-an]. |
| Nr. 136 | 26 | AnAr 10757 (CTH 574). 6.5 × 6.6 cm. “MUŠEN HURRI” oracle; for the frequent occurrence of ^{DUG} haršiyalli in rev. 5', 10', and 11'; cf. KUB 5.7 obv. 2, 12. |
| Nr. 137 | 26 | AnAr 15151 (CTH 580). 6.9 × 7.2 cm. Mixed “MUŠEN” and “KIN” oracles. AnAr 15151 joins KUB 5.17 obv. I (Y. Sakuma). |

Festival Texts (CTH 591–720 “Fêtes et Cultes”)

| | | |
|---------|----|---|
| Nr. 138 | 26 | AnAr 90-6-68 (CTH 591). 4.5 × 2.4 cm. Festival of the Month. For line 3'ff., cf. KBo 20.67 IV 16ff., KBo 17.88 III 10'ff., 23'ff., and KBo 22.201 III 1'ff., IV 3ff. |
| Nr. 139 | 26 | AnAr 70-1-76 (CTH 627). 5.9 × 8.8 cm. KILAM Festival. This is the fragment tentatively called “Ankara 1934,” which is published in Soysal, <i>JCS</i> 50, 59–65, based on a transliteration made by H. G. Güterbock in 1934. Although the fragment in question has now surfaced among the ArAr texts in Ankara, the fate of the other related piece “İzmir 1270++” is still unknown; on the story of this tablet, see Soysal, <i>ibid.</i> , p. 63. |
| Nr. 140 | 27 | AnAr 10285 (CTH 628). 6.3 × 7.7 × 2.5 cm. <i>Hišuwā</i> Festival. Listed in Laroche, <i>CTH</i> , p. 112, under “ <i>autres fragments</i> .” A large part of the surface of this fragment is heavily abraded and unreadable, thus a photo of the tablet is given here instead of a hand copy. |
| Nr. 141 | 28 | AnAr 12157 (CTH 628). 4.7 × 4.7 cm. I 2'–9' are duplicates of KUB 32.128 I 9–15. |

Catalog

| Tablet | Plate | Description |
|---------|-------|--|
| Nr. 142 | 28 | AnAr 8360 i (CTH 634). 3.0 × 2.9 cm. For lines 1'–7', cf. KBo 8.121:6'–9', KBo 46.142 rt. col. 5'–9' and KUB 25.3 obv. III 21–26. |
| Nr. 143 | 28 | AnAr 96-2-76 (CTH 635). 3.7 × 2.7 cm. Obv. 2'–6' are duplicates or parallel to KUB 11.30 + KUB 44.14 IV 22'–27'. This fragment is among the “Kuşsaray” tablets. In his report, Koşay, “ <i>Kuşsaray</i> ,” p. 89, Koşay provides the following information about Kuşsaray: <p style="padding-left: 40px;">“On the orders of the Ministry of Education on May 24, 1966, on behalf of the Ministry and the Turkish Historical Society, the Alacahöyük excavation team conducted a sounding and survey between July 18–25, 1966, with fourteen workers at the Kuşsaray Höyüğü, 15 km south of Çorum, where reportedly some Hittite tablet fragments have been discovered.”</p> |
| Nr. 144 | 28 | AnAr 16-6-68 (CTH 643; see <i>Konkordanz</i>). 3.6 × 3.7 cm. This fragment is from the D. Owen tablets. Lines 2'–7' are duplicates of KUB 25.33 I 3–8. |
| Nr. 145 | 28 | AnAr 9723 (CTH 645). 4.5 × 4.3 cm. II ² 8'–9' are parallel to KUB 58.38 II 2'–3', 8'–9', 15'–16' and (23'). |
| Nr. 146 | 28 | AnAr 12156 (CTH 645 or 458). 4.8 × 5.2 cm. Lines 2'–11' are duplicates of 942/z (cf. E. Neu and Otten, <i>IF</i> 77, 183) obv. ² 1'–5' and rev. ² 1'–3'. Due to the mention of [DINGIR p]iše-neš and DINGIR maliašmiš in line 5' the text reminds one of KUB 43.30 III 10'–11' and KBo 43.75:6'–7' (CTH 645) or KUB 41.23 III 12' (CTH 458.10). |
| Nr. 147 | 28 | AnAr 11502 c (CTH 647). 2.1 × 2.5 cm. Lines 1'–5' are duplicates of KBo 11.45 obv. III 13'–17'. |
| Nr. 148 | 29 | AnAr 10311 (CTH 648). 5.8 × 5.9 cm. For rev. 4'ff., cf. KBo 25.67 rt. col. 12'ff., KBo 30.99 I 2'ff., and KUB 54.50 I ² 11'ff. |
| Nr. 149 | 29 | AnAr 10300 (CTH 649). 3.2 × 4.5 cm. One of the festival descriptions mentioning the NIN.DINGIR priestess. Obv. 5' reads [G ¹⁸ hul]uganni; cf. KBo 17.101 obv. III 11', 15'. |
| Nr. 150 | 29 | AnAr 12176 (CTH 649). 3.0 × 4.5 cm. Line 1': ¹ kar-ap-zi ¹ ; 2': NIN.DINGIR-i IGI-[an-da]; 3': NIN.DINGIR tu- ¹ u ¹ -[ya-az]. |
| Nr. 151 | 29 | AnAr 4220 d (CTH 649). 2.6 × 3.0 cm. For [NI]N.DINGIR-i parā ē[pzi] in line 3', cf. KBo 24.98:10', KUB 53.28 obv. 6'. |
| Nr. 152 | 29 | AnAr 70-2-76 (CTH 664). 6.3 × 4.0 cm. See Akdoğan-Soysal, <i>AMMY</i> 2002, 180–81. |
| Nr. 153 | 29 | AnAr 10299 ([CTH 669]. <i>Addendum</i> : more likely CTH 448). 4.6 × 4.0 cm. For lines 2'–10', cf. duplicate, parallel or similar texts: KBo 39.94 obv. ² 1'–8' (CTH 448.4.5), KBo 15.16 obv. ² II 2'–6' (CTH 448.4.3.b; for the text, see Kümmel, <i>StBoT</i> 3, 138), KBo 16.103:2'–5' (CTH 832), and IBoT 3.129 obv. 1'–10' (CTH 448.4.6). |
| Nr. 154 | 29 | AnAr 3137 (CTH 670). 5.4 × 2.7 cm. Line 2': [ki-i]t-kar-za; 3': [ša]-aš- ¹ ti ¹ . |
| Nr. 155 | 29 | AnAr 6995 (CTH 670?). 4.4 × 3.2 cm. Line 5': ma-a-n[a-aš(-)...]. |
| Nr. 156 | 30 | AnAr 8357/f (CTH 670). 3.0 × 2.4 cm. |
| Nr. 157 | 30 | AnAr 8360 c+g+m (CTH 670). 3.3 × 3.0 cm. Line 5': [L ¹ GU]DU ₁₂ . |
| Nr. 158 | 30 | AnAr 8360 f (CTH 670). 3.0 × 3.1 cm. Line 6': ¹ pa-iz-zi ¹ . |
| Nr. 159 | 30 | AnAr 8360 h (CTH 670). 2.8 × 2.5 cm. Line 2': [ya-a]l-ḫa-an-ni-a[n-zi]; 4': [ḫ]u-ke-eš-kán-z[i]. |
| Nr. 160 | 30 | AnAr 8360 n+s+ş (CTH 670 or 651). 2.4 × 2.9 cm. Line 2' mentions [MUNUS.MEŠ(?)ḫ]a-az-ka ₄ -ra-i; cf. KUB 9.30:5'–7', KUB 58.4 V 11'–14', and KUB 58.1 I (1'–4') (all CTH 651). |
| Nr. 161 | 30 | AnAr 8365 b (CTH 670?). 2.4 × 1.6 cm. |
| Nr. 162 | 30 | AnAr 8857 (CTH 670, or most likely 824). 4.4 × 3.7 cm. In many ways it resembles KBo 22.242 (CTH 824). Line 6': L ¹ .MEŠ ² KUŠ ₇ .GUŠKIN. |

Catalog

| Tablet | Plate | Description |
|---------|-------|---|
| Nr. 163 | 30 | AnAr 8911 (CTH 670). 5.3 × 5.4 cm. Rev. 4': $\text{[na-at}^1\text{ GE}_6\text{-an hu-u-ma-[an-da-an]}$. |
| Nr. 164 | 31 | AnAr 8919 (CTH 670). 3.8 × 4.3 cm. The description in lines 1'–6' is similar to KUB 57.99 IV 3'–7' (CTH 618.5); cf. also KBo 39.86 II 14'–16' (CTH 660.4). |
| Nr. 165 | 31 | AnAr 9145 (CTH 670?). 3.8 × 3.6 cm. It has similarities to a festival description, but a second person is addressed in obv. ² II 2'–3'. Therefore, this fragment may belong to another text genre as well (e.g., prayers, vows, etc.). |
| Nr. 166 | 31 | AnAr 9716 (CTH 670). 3.1 × 2.2 cm. Line 2': $\text{dUTU}^{\text{UR}}[\text{UArinna}]?$ |
| Nr. 167 | 31 | AnAr 9720 (CTH 670?). 2.4 × 2.3 cm. See Akdoğan, <i>AMMY</i> 2005, 204–05, 219. |
| Nr. 168 | 31 | AnAr 9730 (CTH 670). 4.9 × 3.3 cm. Obv. 3': $\text{[ša}^2\text{-r]a-a}$; 4': $\text{[gal-gal-tu-u}^2\text{]-ri}$; 5': $\text{[ha-az-zi-i]k-kán-zi}$. |
| Nr. 169 | 31 | AnAr 10301 (CTH 670). 2.6 × 3.2 cm. For lines 3'–4' with a context mentioning LUGAL, GAL <i>MEŠEDI</i> , and <i>memal</i> , cf. KBo 23.79 II 1–2 (CTH 675), KBo 11.52 VI 22'–23' (CTH 634.1.B), and KUB 34.69 + KUB 34.70 obv. 11'–12' (CTH 609). |
| Nr. 170 | 32 | AnAr 10309 (CTH 670). 7.6 × 5.0 cm. |
| Nr. 171 | 32 | AnAr 10325 (CTH 670). 3.2 × 2.0 cm. Line 2': I GÍN; 3': $\text{da-pí-í[a-an}^2\text{]}$; are lines 4' and 6' to be restored as EGIR-ŠU-ma a-[la-an-ni ...] (cf. KBo 33.201 obv. ² III 13'–15') or as A-[NA ^d ...]? |
| Nr. 172 | 32 | AnAr 10588 (CTH 670?). 6.4 × 2.6 cm. Line 13': [te]-li-pu-u-ri . |
| Nr. 173 | 32 | AnAr 10593 (CTH 670). 5.2 × 5.6 cm. For ^d Karzi and <i>irhāuwar</i> in II ² 7', 9' cf. KBo 21.64 III 5, (12) and KUB 2.13 V 5. |
| Nr. 174 | 33 | AnAr 10596 (CTH 670 or more likely 651). 6.2 × 4.4 cm. II ² 1'–12' are duplicates of or parallel to KUB 58.1 I 6'–17' (CTH 651). |
| Nr. 175 | 33 | AnAr 10597 (CTH 670). 4.2 × 5.5 cm. For the phrase <i>nu</i> MUNUS.LUGAL <i>arāi</i> in obv. 3', see KUB 32.87 rev. 26 (CTH 646.1.A) and cf. also KBo 29.188 IV 14' (CTH 694). |
| Nr. 176 | 33 | AnAr 10604 (CTH 670). 3.3 × 3.6 cm. |
| Nr. 177 | 33 | AnAr 10611 (CTH 670). 3.5 × 3.3 cm. Line 3': $\text{[me}^2\text{]-[e}^1\text{-mí-iš-ki-iz-z[i]}$. |
| Nr. 178 | 34 | AnAr 10758 (CTH 670). 9.6 × 9.4 cm. Lines 9'–10' are duplicates of or parallel to KBo 24.103 V 2'–4' (CTH 670); cf. also KBo 15.36 III 10'–12' (CTH 330.3.A). The script of the fragment exhibits Middle Hittite features. |
| Nr. 179 | 34 | AnAr 10866 (CTH 670). 5.1 × 5.9 cm. Line 4': <i>ta-ma-iš</i> ; 5': ^{GIŠ} ERIN BIR ₉ .R[A] “burnt cedar wood.” |
| Nr. 180 | 34 | AnAr 11246 h (CTH 670?). 2.8 × 2.2 cm. Contains a bread (offering) list. Line 1': [NINDA.GUR ₄ .R]A. |
| Nr. 181 | 34 | AnAr 11288 a (CTH 670). 8.4 × 3.4 cm. |
| Nr. 182 | 34 | AnAr 11288 b (CTH 670). 5.0 × 3.3 cm. Possibly belongs to the same tablet as ABoT II 181 (AnAr 11288 a), but it is not a direct join. |
| Nr. 183 | 34 | AnAr 11385b (CTH 670). 2.3 × 2.9 cm. |
| Nr. 184 | 35 | AnAr 11402 a (CTH 670 or 738). 2.3 × 2.6 cm. Line 1': $\text{[ha-a]z-[ze}^1\text{-eš-kán-z[i]}$; lines 1'–3' are duplicates of or parallel to KBo 19.138 obv. 5'–7' (CTH 738.I.7.B); cf. also KBo 24.98:1'–2' (CTH 738.I.7.A). |
| Nr. 185 | 35 | AnAr 11503 b (CTH 670). 3.3 × 2.2 cm. |
| Nr. 186 | 35 | AnAr 11504 (CTH 670). 3.1 × 1.9 cm. |

Catalog

| Tablet | Plate | Description |
|---------|-------|--|
| Nr. 187 | 35 | AnAr 11619 a (CTH 670). 3.8 × 4.1 cm. |
| Nr. 188 | 35 | AnAr 11621 b (CTH 670?). 3.2 × 3.2 cm. For lines 3'–4', cf. KUB 2.6 II 1–2 (CTH 598.1.A). |
| Nr. 189 | 35 | AnAr 12166 (CTH 670). 7.7 × 4.5 cm. Lines (1'), (12'), (14'): ^{LÚ} ḫa-mi-na(-aš); 8': I ú-i-ri-ia-a[š-ša ² -an ²]; (13'), (19'), (20'): ^{NINDA} ši-lu-ḫa-a-an(-ma); 22': ku-ri- ¹ ya ² 1-nu-uš-ša. |
| Nr. 190 | 35 | AnAr 12169 (CTH 670). 3.2 × 3.9 cm. Contains a list of offerings to the gods; see Akdoğan, <i>AMMY</i> 2005, 198–99. |
| Nr. 191 | 35 | AnAr 12178 (CTH 670?). 3.6 × 1.7 cm. |
| Nr. 192 | 35 | AnAr 12186 (CTH 670). 2.1 × 0.8 cm. Left edge 2' mentions ^{URU} Da-a-ú-[ni-ia]. The script resembles the Middle Hittite ductus. |
| Nr. 193 | 36 | AnAr 12188 (CTH 670). 3.7 × 3.4 cm. |
| Nr. 194 | 36 | AnAr 14839 b (CTH 670). 6.2 × 5.7 cm. For obv. 2'–4' cf. VS 28.33 III 25–26, 28–29; see R. Akdoğan, <i>AMMY</i> 2005, 204, 218. |
| Nr. 195 | 36 | AnAr 14839 c (CTH 670). 3.5 × 2.5 cm. For lines 1'–7', cf. KUB 53.44 IV 1'ff., 4'–6' (CTH 647.16). |
| Nr. 196 | 36 | AnAr 14923 (CTH 670). 5.9 × 4.2 cm. Obv. ² I ² 10': ir-ḫa-[iz-z]i. |
| Nr. 197 | 36 | AnAr 14926 (CTH 670). 6.3 × 3.5 cm. |
| Nr. 198 | 36 | AnAr 14927 (CTH 670). 4.0 × 2.2 cm. Line 6': [^{LÚ} ALAN.Z]U ₉ . |
| Nr. 199 | 36 | AnAr 14928 (CTH 670?). 4.8 × 4.6 cm. In obv. 2 the spelling [^{UR}]U ² Zi-ip-pal-an-da is noticeable. |
| Nr. 200 | 36 | AnAr 14936 (CTH 670?). 3.5 × 2.5 cm. |
| Nr. 201 | 37 | AnAr 14939 (CTH 670?). 2.7 × 1.9 cm. Line 1': [^N]A ² ZI.KIN.ḪI.1A ¹ . |
| Nr. 202 | 37 | AnAr 14942 (CTH 670). 2.6 × 2.2 cm. |
| Nr. 203 | 37 | AnAr 14967 (CTH 670). 2.6 × 2.3 cm. |
| Nr. 204 | 37 | AnAr 14970 (CTH 670). 2.0 × 4.2 cm. |
| Nr. 205 | 37 | AnAr 14971 (CTH 670 or 663?). 4.6 × 2.7 cm. For cult descriptions involving ^{LÚ.MEŠ} DUGUD(-TIM) as here in line 5', see also HT 19:7'–9' (CTH 663.4.A), IBoT 2.65:10'–11' (663.4.B), IBoT 3.23 obv. ² III ² 10'–13' (CTH 663), and KUB 28.97 III 9'–10' (CTH 744). |
| Nr. 206 | 37 | AnAr 14972 (CTH 670). 2.4 × 2.1 cm. For lines 2'–3', cf. KBo 20.74 rev. ² III 10'–11' (CTH 635?). |
| Nr. 207 | 37 | AnAr 14984 (CTH 670?). 1.6 × 2.3 cm. Line 1': ¹ LÚki-ta-a1-[aš]; 3': DINGIR.LÚ.MEŠ. |
| Nr. 208 | 37 | AnAr 15160 (CTH 670?). 3.4 × 0.9 cm. |
| Nr. 209 | 37 | AnAr 21627 (CTH 670). 3.4 × 5.6 cm. Rev. 2': XXIV- ¹ ŠU ¹ ; rev. 4'–8' are similar to KUB 33.79 rev. ² IV 4'–9' (CTH 332.4). |
| Nr. 210 | 38 | AnAr 21632 (CTH 670). 4.2 × 3.3 cm. Obv. 4: [ar-ḫ]a; 6: BÉ-EL S[ISKUR ²]. |
| Nr. 211 | 38 | AnAr 21633 (CTH 670). 2.8 × 3.8 cm. Line 7': ¹ LUGAL-uš ¹ . For descriptions similar to 2'–7', cf. KBo 34.146 IV 2'–5' (CTH 591.I.b.C), KBo 41.86 II 2'–5' (CTH 650), and KBo 25.105 rev. 2'–4' (CTH 669.25.C). |
| Nr. 212 | 38 | AnAr 28-3-66 (CTH 670?). 2.9 × 3.0 cm. |
| Nr. 213 | 38 | AnAr 151-1-67 (CTH 670). 6.8 × 4.6 cm. Cf. CTH 669, 675, and 744.19. For a text edition of this fragment, see Akdoğan-Soysal, <i>AMMY</i> 2002: 172–76. |

Catalog

| Tablet | Plate | Description |
|---------|-------|---|
| Nr. 214 | 38 | AnAr 16-1-68 (CTH 670; see <i>Konkordanz</i>). 5.2 × 4.3 cm. Another fragment from the D. Owen tablets. Obv. I ² : [a]n-da; 3: [p]é-e-di ti-it-ta-nu-ù[a-an-zi]. |
| Nr. 215 | 38 | AnAr 16-2-68 (CTH 670; see <i>Konkordanz</i>). 4.2 × 3.2 cm. From the D. Owen tablets. |
| Nr. 216 | 38 | AnAr 16-3-68 (CTH 670; see <i>Konkordanz</i>). 3.9 × 3.2 cm. From the D. Owen tablets. |
| Nr. 217 | 39 | AnAr 16-4-68 (CTH 670; see <i>Konkordanz</i>). 3.2 × 1.5 cm. From the D. Owen tablets. It contains a list of bread offerings to the gods; cf. KBo 47.14 obv. 1'ff. (CTH 470), KBo 53.146 obv. 1ff. (CTH 670), and KUB 27.1 I 54ff., II 46ff. (CTH 712.A). <i>Addendum</i> : ABoT II 217 now directly joins KBo 54.222 (CTH 712). |
| Nr. 218 | 39 | AnAr 16-8-68 (CTH 670; see <i>Konkordanz</i>). 2.8 × 4.8 cm. |
| Nr. 219 | 39 | AnAr 16-9-68 (CTH 670 [see <i>Konkordanz</i>] or 790). 3.1 × 4.2 cm. From the D. Owen tablets. For [LÚ.ME] ^s zuppariyalle[š] in line 2' and ^d (^l)apir[eš] in line 3', cf. KBo 39.187 + KBo 34.187 rt. col. 11'–12', 14'–15' (CTH 670), KBo 39.190 II 4' (CTH 790), and KUB 45.49 IV 3 (CTH 790). |
| Nr. 220 | 39 | AnAr 16-10-68 (CTH 670). 3.8 × 6.6 cm. Another fragment from the D. Owen tablets. |
| Nr. 221 | 39 | AnAr 16-11-68 (CTH 670). 3.9 × 1.8 cm. From the D. Owen tablets. Left edge 1'–2' to be read [ANA GIŠ].ḪUR-kán / [ḫa-an-d]a-a-an. |
| Nr. 222 | 39 | AnAr 90-2-68 (CTH 670). 4.9 × 3.3 cm. For obv. II ² 3', 7'–11', cf. KBo 30.56 V 11', 15', 22'–29' (CTH 669). |
| Nr. 223 | 40 | AnAr 87-2-06 (CTH 670). 7.5 × 8.3 cm. For a text edition of this fragment see Akdoğan, <i>AMMY</i> 2006, 163–77, and eadem in FsWilhelm, 17–26. For the co-attestation of taknaš ^d UTU(-waš É) in obv. II 8 and ^{LÚ} ḫamina- in rev. V 2', cf. KBo 11.49 I 5', 9'–10' (CTH 592.2.II?.1.A) and especially IBoT 3.44 obv. 3–4, rev. 5–6 (CTH 635?). |
| Nr. 224 | 40 | AnAr 4038 (CTH 670). 7.6 × 4.2 cm. Obv. 10': [ḫal]-za-a- ^r i ^l ; 13': LUGAL-i ^r pa-a ^l -[i]. For obv. 3'–13', cf. KUB 25.9 III 4'–18' (CTH 634.2.B), KUB 1.17 I 2–12 (CTH 591.II.A), and KBo 14.31 I 2–5 (CTH 670). |
| Nr. 225 | 40 | AnAr 11619 b (CTH 670 or 685?). 2.3 × 2.9 cm. Fragment with religious context. In line 2' ^d LAMMA is mentioned and therefore this may be a festival description, ritual, or even a mythological text. |
| Nr. 226 | 41 | AnAr 11202 (CTH 678). 16.0 × 8.4 cm. Rev. 9': [^d Ḫat]epuna or [^d Tel]ipuna; 23': ^{LÚ} [SANGA] ^l ^d U; 26": [GIŠ ^d INANN]A.GAL; 27": [^d Me- <i>ez-zu-ul-l</i>]a ^r TUŠ ^l -aš; 28" and 30": [S]IR-RU; 29": [^d U ^{URU} Zi-i]p-la-an- ^r la. |
| Nr. 227 | 42 | AnAr 12131 a (CTH 691). 4.7 × 6.6 cm. <i>Witaššiya</i> Festival. Obv. I ² 5': [me]- ^r e ^l -ḫu-ni. The fragment exhibits Middle Hittite script. Obv. II ² 1–5 are parallel to KUB 27.59 I 6–9. |
| Nr. 228 | 42 | AnAr 10307 (CTH 692). 7.0 × 5.8 cm. <i>Witaššiya</i> Festival. The fragment exhibits Middle Hittite script. For the passages in obv. 8'ff. and rev. 6'ff., see KBo 24.22:2'ff. AnAr 10307 belongs most likely to the same tablet as KBo 29.130. Both fragments form the right edge of the tablet. Since the obv. of KBo 29.130 is the bottom of the tablet, AnAr 10307 should be placed somewhere before line 1' of KBo 29.130 obv. |
| Nr. 229 | 43 | AnAr 26-1-68 (CTH 693?). 4.2 × 4.8 cm. For lines 2'ff., see KBo 24.24 III 4'ff. (CTH 693) and KBo 14.89 + I 13'ff. (CTH 693). |
| Nr. 230 | 43 | AnAr 16-7-68 (CTH 701; see <i>Konkordanz</i>). 4.8 × 3.4 cm. Another fragment from the D. Owen tablets. For the content of obv. 7'ff., see KBo 27.162 rt. col. 4'ff. (CTH 701.b ₂ .F); for rev. 1'–4', cf. KBo 23.45 IV 4, 12–16 (701.b.VII.A). |
| Nr. 231 | 43 | AnAr 21629 + KBo 11.5 + KBo 11.58 (CTH 703.2.B). 9.4 × 13.3 cm. For the text edition, see Akdoğan-Wilhelm, <i>AMMY</i> 2001, 244–45, and ZA 93, 223–27. |

Catalog

| Tablet | Plate | Description |
|--|-------|--|
| Nr. 232 | 44 | AnAr 9150 (CTH 704 or 705). 1.4 × 1.9 cm. A Kizzuwatnan festival, ritual or an offering list to Hurrian divinities. Obv. 1' should be read [<i>tūn</i>]i <i>tapri</i> ; for this term, see KUB 25.44 II 4' (CTH 704), KBo 23.67 II 9' (CTH 704), and KBo 14.138:9 (CTH 705). For the geographical name [^{URU} D]ašimūwa in obv. 2', cf. ^{URU} Tašimuaz in KUB 60.148 I 11. |
| Texts in Other Languages (CTH 725–791 “Langues Étrangères”) | | |
| Nr. 233 | 44 | AnAr 12168 (CTH 732; <i>Konkordanz</i> : CTH 745). 4.8 × 4.6 cm. Hattian “Ḫutuši Ritual.” See Akdoğan-Soysal, <i>AMMY</i> 2002, 183–84. This fragment is also mentioned in Soysal, <i>HWHT</i> , 68, and utilized for the lexical list. |
| Nr. 234 | 44 | AnAr 3136 (CTH 735; <i>Konkordanz</i> : CTH 745). 5.0 × 7.3 cm. A monolingual Hattian fragment. It shows features of Old Hittite ductus, and in terms of composition it has close similarities to KUB 28.23 (CTH 735). This fragment is mentioned in Soysal, <i>HWHT</i> , 68, and utilized for the lexical list. |
| Nr. 235 | 44 | AnAr 10610 (CTH 738; <i>Konkordanz</i> : CTH 650). 3.0 × 3.9 cm. Already listed in CTH Premier supplément under nr. 738.5. It contains the Hattian hymn of <i>taššaninna</i> sung by the <i>zintuḫi</i> -women; lines 2'–6' are parallel to KBo 19.163 I 9'–11', KBo 21.95 I 8'–10', KBo 21.96:7'–10', KBo 21.100 obv. 11'–13', KBo 21.102 rev. 10'–12', KBo 21.106 obv. 9'–12', and KBo 44.136 obv. [?] 12'–15'. |
| Nr. 236 | 44 | AnAr 12175 (CTH 745). 2.6 × 3.7 cm. Hattian. See Akdoğan-Soysal, <i>AMMY</i> 2002, 184–85. This fragment is mentioned in Soysal, <i>HWHT</i> , 68, and utilized for the lexical list. |
| Nr. 237 | 44 | AnAr 11502 b (CTH 758). 3.6 × 3.0 cm. “Puriyanni Ritual.” For lines 1'–3', cf. KUB 35.54 III 3–5. |
| Nr. 238 | 45 | AnAr 8918 (CTH 760). 3.9 × 2.9 cm. “ ^{MUNUS} ŠU.GI Ritual.” For lines 1'–5', cf. KUB 9.34 I 30'–33', IV 8'–12', IBoT 3.102:8'–13', and KBo 24.3 I 9–12. |
| Nr. 239 | 45 | AnAr 11621 d+g (CTH 760). 3.8 × 2.5 cm. For lines 2'–3', see KUB 35.59 + KBo 29.13 II 4'–5' (CTH 760 II 3). |
| Nr. 240 | 45 | AnAr 14917 (CTH 760?). 6.4 × 4.1 cm. With mention of ŠA ^d Pann[unta ŠAḫ.TUR] in lines 3' and 6'; cf. KUB 9.4 III 22', 25', IV (21'), (29')–30' and KBo 29.196 rev. [?] 3'. |
| Nr. 241 | 45 | AnAr 14839 a (CTH 763). 6.1 × 3.8 cm. Ritual with Luwian passages. |
| Nr. 242 | 45 | AnAr 14914 (CTH 763). 4.5 × 3.2 cm. Perhaps a ritual; contains Luwian in obv. 7'–8'; for lines 6'–7', cf. KUB 32.70 rt. col. 4'–5' (CTH 763). Further passages with similar context are: KUB 17.15 II 9'ff. (CTH 767.2.C), KUB 9.4 III 42' (CTH 760.I.2), and KUB 35.145 obv. 3'–4' (CTH 767.2.A). |
| Nr. 243 | 46 | AnAr 9251 (CTH 764.I). 7.5 × 5.8 cm. Mythology and magic. Written in Middle Hittite script. Text edition is in Akdoğan, <i>FsKošak</i> , 1–12. For obv. 10', cf. KBo 12.89 III 9'–10'. |
| Nr. 244 | 46 | AnAr 12170 (CTH 767). 4.8 × 3.0 cm. Magical context with Luwian influence. Lines 3'–9' are duplicates of or parallel to KUB 35.143:4'–12' (CTH 767.2.B). |
| Nr. 245 | 46 | AnAr 10319 (CTH 780). 4.8 × 3.2 cm. “Allaituraḫi Ritual.” Lines 2'–9' are duplicates of VS 28.57 IV 5'–12'. |
| Nr. 246 | 46 | AnAr 12131 c (CTH 788?). 3.3 × 6.2 cm. Resembling the “Šalašu Ritual.” |
| Nr. 247 | 46 | AnAr 42-2-66 (CTH 789). 3.5 × 3.9 cm. Hittite fragment belonging to the Hurrian “Song of Release.” Obv. 2': ^m Me-ge-e[š]. According to the sign “da” in line 5' the script should be New Hittite; cf. KBo 57.180 and relevant discussions by J. L. Miller, KBo 57, pp. IX–X. |

Catalog

| <i>Tablet</i> | <i>Plate</i> | <i>Description</i> |
|---------------|--------------|--|
| Nr. 248 | 47 | AnAr 14918 (CTH 790). 5.4 × 4.9 cm. Ritual containing Hurrian. For line 4', cf. KBo 11.19 obv. 13' (CTH 788.2.A). |
| Nr. 249 | 47 | AnAr 10318 (CTH 791; <i>Konkordanz</i> : CTH 370.II). 4.7 × 3.9 cm. Hurrian. Obv. II' 4'–5' are parallel to KUB 47.17:2'–3'. This fragment is cited in Laroche, <i>GLH</i> 1, 144, under the lemma <i>gešhena</i> , and transliterated in Salvini-Wegner, <i>ChS</i> I/6, 53 (nr. 22). |
| Nr. 250 | 47 | AnAr 10595 (CTH 791). 4.9 × 4.5 cm. Hurrian. The words of this fragment are listed in Laroche, <i>GLH</i> , and the transliteration of the text is given in Trémouille, <i>ChS</i> I/8, 84 (nr. 163). |
| Nr. 251 | 47 | AnAr 11616 a (CTH 791). 2.9 × 2.6 cm. Hurrian text of unknown genre. |
| Nr. 252 | 47 | AnAr 12155 (CTH 791). 7.4 × 8.3 cm. Hurrian. For the text edition see Akdoğan-Wilhelm, <i>AMMY</i> 2001, 246–47, and <i>ZA</i> 93, 227–30; cf. also Trémouille, <i>ChS</i> I/8, 16 (nr. 19). |

Sumerian and Akkadian Texts (CTH 792–819 “Littérature Suméro-Akkadienne”)

| | | |
|---------|----|--|
| Nr. 253 | 48 | AnAr 8915 (CTH 819). 8.0 × 5.3 cm. Akkadian. Perhaps the same composition as ABoT II 262 (AnAr 11619 c+e); the fragments, however, are from different tablets. |
| Nr. 254 | 48 | AnAr 8917 (CTH 819). 4.5 × 5.2 cm. Perhaps of historical nature; thus, an Akkadian treaty or letter (CTH 208 or 216?). |
| Nr. 255 | 48 | AnAr 9167 (CTH 819). 7.5 × 7.4 cm. Sumerian. |
| Nr. 256 | 48 | AnAr 10321 (CTH 819). 3.4 × 3.3 cm. Akkadian omen / divination text? |

Varia and Texts of Unknown Type (CTH 820–833 “Varia”)

| | | |
|---------|----|--|
| Nr. 257 | 48 | AnAr 8360 d (CTH 831). 2.1 × 3.0 cm. Non-Hittite; perhaps Hurrian. |
| Nr. 258 | 49 | AnAr 10873 (CTH 831). 4.4 × 7.1 cm. Non-Hittite. <i>Addendum</i> : According to G. Beckman (personal communication), an Akkadian incantation with Sumerian rubric (KA.INIM.MA); thus, rather to CTH 819. |
| Nr. 259 | 49 | AnAr 11246 i (CTH 831). 3.4 × 4.0 cm. A Non-Hittite language. |
| Nr. 260 | 49 | AnAr 11617b (CTH 831). 3.9 × 4.1 cm. Possibly Non-Hittite. |
| Nr. 261 | 49 | AnAr 11616 c (CTH 831). 3.4 × 2.9 cm. Hurrian or Hattian? |
| Nr. 262 | 49 | AnAr 11619 c+e (CTH 831). 4.3 × 2.1 cm. Non-Hittite; perhaps Akkadian. This fragment may belong to the same composition as ABoT II 253 (AnAr 8915). |
| Nr. 263 | 49 | AnAr 14935 (CTH 831). 3.5 × 2.0 cm. Possibly Hurrian. |
| Nr. 264 | 49 | AnAr 6966 (CTH 832). 4.4 × 5.7 cm. |
| Nr. 265 | 50 | AnAr 6968 (CTH 832). 2.8 × 2.9 cm. Line 3': <i>a-ap-[pa]</i> . |
| Nr. 266 | 50 | AnAr 6988 (CTH 832). 2.2 × 3.0 cm. |
| Nr. 267 | 50 | AnAr 6996 (CTH 832). 2.9 × 1.8 cm. Possibly of religious nature. Line 5': <i>[IŠ]-TU^UZU^UĪ</i> . |
| Nr. 268 | 50 | AnAr 7002 (CTH 832). 4.9 × 6.0 cm. |
| Nr. 269 | 50 | AnAr 7004 (CTH 832). 2.2 × 3.0 cm. |
| Nr. 270 | 50 | AnAr 8354 (CTH 832). 6.4 × 4.0 cm. |
| Nr. 271 | 50 | AnAr 8355 (CTH 832). 7.6 × 5.4 cm. Omen / divination text? |
| Nr. 272 | 51 | AnAr 8358 c (CTH 832). 1.9 × 1.8 cm. |

Catalog

| <i>Tablet</i> | <i>Plate</i> | <i>Description</i> |
|---------------|--------------|--|
| Nr. 273 | 51 | AnAr 8360 b (CTH 832). 5.7 × 3.0 cm. |
| Nr. 274 | 51 | AnAr 8360 ç (CTH 832). 2.5 × 2.1 cm. May be of religious nature if the single curved-up line on the left column reads [ma]-al-di. |
| Nr. 275 | 51 | AnAr 8360 e (CTH 832). 2.8 × 2.5 cm. See Akdoğan, <i>AMMY</i> 2005, 202, 216. |
| Nr. 276 | 51 | AnAr 8360 g (CTH 832). 1.7 × 2.5 cm. |
| Nr. 277 | 51 | AnAr 8360 j (CTH 832). 2.1 × 2.1 cm. Line 1': [p]é- ^l en-na ^l -[i?]. |
| Nr. 278 | 51 | AnAr 8360 k (CTH 832). 1.5 × 2.5 cm. A “dream and vow” (CTH 584, 590) or oracular text (CTH 577–579). Line 2': MUNUS.L[UGAL]; 3': AŠ ^{URU} Kum-[ma-an-ni(?)]. |
| Nr. 279 | 51 | AnAr 8360 r (CTH 832). 3.2 × 2.5 cm. May be of historical nature; letter or treaty? Line 4': [E]N-KA-ma. |
| Nr. 280 | 51 | AnAr 8364 (CTH 832). 6.1 × 5.2 cm. |
| Nr. 281 | 52 | AnAr 8365 a (CTH 832). 2.8 × 2.5 cm. May be of historical nature. Line 2': [l]i-in-kir; 5': GIŠTUKUL.GÍ[D.DA]. |
| Nr. 282 | 52 | AnAr 8365 ç (CTH 832). 2.7 × 1.8 cm. |
| Nr. 283 | 52 | AnAr 8365 ğ (CTH 832). 2.4 × 1.6 cm. Line 3': MUNUS.LUGA[L]. |
| Nr. 284 | 52 | AnAr 8844 a (CTH 832). 2.3 × 2.3 cm. Line 4' is perhaps to be restored as ^{URU} Kum[manni]. The script of the fragment is identical with that in ABoT II 285 (AnAr 8844 c); thus, they likely belong to the same tablet. |
| Nr. 285 | 52 | AnAr 8844 c (CTH 832). 1.4 × 1.9 cm. Possibly an inventory text. Line 1': KISLAḪ LUGAL? This belongs likely to the same tablet as ABoT II 284 (AnAr 8844 a). |
| Nr. 286 | 52 | AnAr 8845 (CTH 832). 4.4 × 3.0 cm. |
| Nr. 287 | 52 | AnAr 8846 (CTH 832). 3.4 × 4.6 cm. |
| Nr. 288 | 52 | AnAr 8850 (CTH 832). 2.1 × 2.6 cm. Line 1': É- ^l ir-za-ma ^l . |
| Nr. 289 | 52 | AnAr 8852 (CTH 832). 3.3 × 3.1 cm. |
| Nr. 290 | 52 | AnAr 8853 (CTH 832). 2.4 × 2.2 cm. |
| Nr. 291 | 52 | AnAr 8856 (CTH 832). 3.6 × 5.6 cm. |
| Nr. 292 | 53 | AnAr 8913 (CTH 832; <i>Konkordanz</i> : CTH 215.?). 4.0 × 2.4 cm. See Akdoğan, <i>AMMY</i> 2005, 202–04, 217. |
| Nr. 293 | 53 | AnAr 8920 (CTH 832). 5.5 × 3.6 cm. |
| Nr. 294 | 53 | AnAr 8921 (CTH 832). 2.9 × 2.0 cm. |
| Nr. 295 | 53 | AnAr 8922 (CTH 832). 4.8 × 3.2 cm. |
| Nr. 296 | 53 | AnAr 9143 (CTH 832). 5.3 × 4.1 cm. |
| Nr. 297 | 53 | AnAr 9144 (CTH 832). 4.9 × 6.7 cm. |
| Nr. 298 | 53 | AnAr 9460 (CTH 832). 2.5 × 2.4 cm. Perhaps of religious nature. |
| Nr. 299 | 54 | AnAr 9461 (CTH 832). 2.3 × 2.4 cm. |
| Nr. 300 | 54 | AnAr 9462 (CTH 832). 3.2 × 1.9 cm. Akkadian. Most likely correspondence between Hatti and Egypt (CTH 170?). For the words <i>ša-ni-e</i> and <i>a-ḫi-ia</i> in lines 5'–6', cf. KUB 3.69 rev. 6 (<i>ša-ni-i</i>), 8 (<i>ŠEŠ-ia</i>); see Edel, <i>ÄHK</i> I, 90. |
| Nr. 301 | 54 | AnAr 9463 (CTH 832). 1.8 × 2.9 cm. |
| Nr. 302 | 54 | AnAr 9467 (CTH 832). 3.7 × 2.0 cm. |

Catalog

| <i>Tablet</i> | <i>Plate</i> | <i>Description</i> |
|----------------|--------------|--|
| Nr. 303 | 54 | AnAr 9470 (CTH 832). 2.3 × 4.5 cm. Perhaps of religious nature. For the usage GE ₆ - <i>ti-ma</i> in line 4', cf. GE ₆ .KAM- <i>ti-ia</i> in KUB 33.102 II 13. |
| Nr. 304 | 54 | AnAr 9718 (CTH 832). 3.7 × 2.3 cm. |
| Nr. 305 | 54 | AnAr 9719 (CTH 832). 3.8 × 2.0 cm. Colophon of a tablet. Line 3': INIM [x][...]. |
| Nr. 306 | 54 | AnAr 9728 (CTH 832). 4.6 × 3.9 cm. Due to Akkadian <i>IKRŪB</i> in line 4' may be a text on dream and vow (CTH 590?). |
| Nr. 307 | 54 | AnAr 9729 (CTH 832). 2.8 × 2.3 cm. |
| Nr. 308 | 55 | AnAr 9731 (CTH 832). 4.0 × 4.7 cm. Perhaps of religious nature. |
| Nr. 309 | 55 | AnAr 9732 (CTH 832). 2.1 × 2.9 cm. |
| Nr. 310 | 55 | AnAr 10314 (CTH 832). 4.4 × 4.5 cm. Line 2': [LUGAL ²]- <i>u-iz-zi-ī</i> [<i>a</i> -...]; 5': [m...]- <i>li-in-na</i> LUGAL- <i>iz-ni</i> "and [...]li (PN, accusative) to the kingship [...]." |
| Nr. 311 | 55 | AnAr 10316 (CTH 832). 3.4 × 3.9 cm. Ritual or medical text? |
| Nr. 312 | 55 | AnAr 10317 (CTH 832). 3.4 × 4.0 cm. Mentions ^m <i>Muršili</i> in line 4' and may have a historical content; a treaty or protocol (CTH 212, 275)? |
| Nr. 313 | 55 | AnAr 10323 (CTH 832). 4.0 × 2.5 cm. |
| Nr. 314 | 55 | AnAr 10324 (CTH 832). 2.3 × 2.6 cm. Line 4' is possibly to be read [DINGIR.M]EŠ ŠA <KUR> <i>Kar-an-d</i> [<i>u-ni-ia</i>]. |
| Nr. 315 | 55 | AnAr 10601 a (CTH 832). 3.5 × 2.0 cm. |
| Nr. 316 | 55 | AnAr 10601 b (CTH 832). 3.2 × 2.6 cm. |
| Nr. 317 | 56 | AnAr 10607 (CTH 832). 4.5 × 3.1 cm. Instruction or prayer? |
| Nr. 318 | 56 | AnAr 10608 (CTH 832). 3.0 × 3.2 cm. "KIN" oracle or conjuration of a ritual? |
| Nr. 319 | 56 | AnAr 10759 (CTH 832). 7.4 × 6.6 cm. Exhibits features of Old Hittite script. Obv. 2': [<i>ut-n</i>] <i>i-ia-an-ta-an</i> . |
| Nr. 320 | 56 | AnAr 11240 a (CTH 832). 2.3 × 2.1 cm. Line 2': [š] <i>u-up-pí-iš</i> . |
| Nr. 321 | 56 | AnAr 11240 b (CTH 832). 3.1 × 2.4 cm. |
| Nr. 322 | 56 | AnAr 11246 f (CTH 832). 1.6 × 1.9 cm. Because of its careless [?] script may be an oracular text. |
| Nr. 323 | 57 | AnAr 11246 i (CTH 832). 3.1 × 3.4 cm. Line 4': [<i>h</i>] <i>u-i-nu-mi</i> ; 6': [š] <i>u-un-^lna-an-z^l</i> [<i>i</i>]. |
| Nr. 324 | 57 | AnAr 11385 a (CTH 832). 4.8 × 2.8 cm. According to G. Beckman (personal communication), a ritual with incantation. |
| Nr. 325 | 57 | AnAr 11390 (CTH 832). 2.3 × 3.0 cm. |
| Nr. 326 | 57 | AnAr 11392 (CTH 832). 3.0 × 3.0 cm. Perhaps of religious nature. |
| Nr. 327 | 57 | AnAr 11393 (CTH 832). 2.4 × 3.9 cm. |
| Nr. 328 | 57 | AnAr 11404 (CTH 832). 2.5 × 2.2 cm. Prayer or vow? Line 1': [<i>ne-p</i>] ^[í-š^la-aš^l] [...]. |
| Nr. 329 | 57 | AnAr 11500 (CTH 832). 5.2 × 4.9 cm. Contains repetitive clauses. Line 7': <i>pé-eš-š</i> [<i>i-ia-az²-zi</i>]. |
| Nr. 330 | 57 | AnAr 11617 a (CTH 832). 5.5 × 4.4 cm. |
| Nr. 331 | 58 | AnAr 11621 e (CTH 832). 3.0 × 2.2 cm. |
| Nr. 332 | 58 | AnAr 12131 g (CTH 832). 2.8 × 1.5 cm. |
| Nr. 333 | 58 | AnAr 12163 (CTH 832 or 212, 275; <i>Konkordanz</i> : CTH 470). 3.0 × 4.5 cm. Of historical content, or more likely an instruction / protocol? For the text, see Akdoğan, <i>AMMY</i> 2005, 197–98. |

Catalog

| <i>Tablet</i> | <i>Plate</i> | <i>Description</i> |
|----------------|--------------|---|
| Nr. 334 | 58 | AnAr 12180 (CTH 832). 2.0 × 1.4 cm. |
| Nr. 335 | 58 | AnAr 12181 (CTH 832). 4.0 × 2.7 cm. |
| Nr. 336 | 58 | AnAr 12182 (CTH 832). 5.0 × 3.0 cm. |
| Nr. 337 | 58 | AnAr 12189 (CTH 832). 2.5 × 3.5 cm. |
| Nr. 338 | 58 | AnAr 12196 (CTH 832). 2.0 × 2.0 cm. Inventory text? |
| Nr. 339 | 58 | AnAr 12197 (CTH 832). 2.6 × 3.3 cm. Festival description? Line 3': <i>kar-š[a-an-zi]</i> ; 5': <i>ku-in</i> . |
| Nr. 340 | 59 | AnAr 14455 (CTH 832). 2.3 × 1.8 cm. Line 2': <i>KI-LI-LI</i> [^{HI.A}]? |
| Nr. 341 | 59 | AnAr 14924 (CTH 832). 3.0 × 3.3 cm. |
| Nr. 342 | 59 | AnAr 14925 (CTH 832). 5.4 × 4.3 cm. Historical or administrative text? |
| Nr. 343 | 59 | AnAr 14929 (CTH 832). 4.6 × 3.4 cm. |
| Nr. 344 | 59 | AnAr 14930 (CTH 832). 4.9 × 4.9 cm. Line 3': [<i>t</i>] <i>u-el É-KA</i> . |
| Nr. 345 | 59 | AnAr 14937 (CTH 832). 3.7 × 3.5 cm. |
| Nr. 346 | 59 | AnAr 14938 (CTH 832). 3.2 × 1.9 cm. Line 6': <i>ì-it</i> . |
| Nr. 347 | 60 | AnAr 14941 (CTH 832). 2.8 × 2.1 cm. |
| Nr. 348 | 60 | AnAr 14944 (CTH 832). 4.9 × 2.0 cm. Probably of historical content. If the line after the double paragraph strokes on the reverse is to be read [... LUGAL.GA]L LUGAL KU[R ^{URU} ...], this may include an introduction with a royal name. |
| Nr. 349 | 60 | AnAr 14947 (CTH 832). 2.3 × 2.2 cm. Line 2': GEŠTIN.SIG ₅ . |
| Nr. 350 | 60 | AnAr 14954 (CTH 832). 2.8 × 2.4 cm. Perhaps of religious nature. |
| Nr. 351 | 60 | AnAr 14957 (CTH 832). 2.4 × 3.1 cm. |
| Nr. 352 | 60 | AnAr 14964 (CTH 832). 2.8 × 2.5 cm. |
| Nr. 353 | 60 | AnAr 14968 (CTH 832; <i>Konkordanz</i> : CTH 238?). 2.5 × 3.1 cm. See Akdoğan, <i>AMMY</i> 2005, 199. Includes a list of geographical names. ^{URU} š ^{anap} [<i>ra</i> ²] in line 5' occurs also in KUB 26.43 obv. 26 (CTH 225.A). |
| Nr. 354 | 60 | AnAr 14969 (CTH 832). 4.4 × 2.2 cm. Perhaps of religious nature; ritual? |
| Nr. 355 | 61 | AnAr 14974 (CTH 832). 2.8 × 2.1 cm. |
| Nr. 356 | 61 | AnAr 14975 (CTH 832). 2.3 × 1.9 cm. |
| Nr. 357 | 61 | AnAr 14978 (CTH 832). 4.5 × 3.5 cm. A religious fragment. [<i>nu</i>]- <i>ut-ták-kán</i> in line 10' refers to a second person being addressed. |
| Nr. 358 | 61 | AnAr 14981 (CTH 832). 3.3 × 2.0 cm. |
| Nr. 359 | 61 | AnAr 14982 (CTH 832). 3.6 × 1.7 cm. |
| Nr. 360 | 61 | AnAr 14983 (CTH 832). 2.9 × 3.5 cm. Contains frequent uses of second-person imperatives (singular and plural); thus, an instruction, treaty or protocol? |
| Nr. 361 | 61 | AnAr 15154 (CTH 832). 3.8 × 4.4 cm. Apparently a long list of leather products; thus possibly an inventory text. Cf. KUB 60.29 obv. [?] 7'–11' (CTH 250). |
| Nr. 362 | 61 | AnAr 15156 (CTH 832). 3.7 × 3.0 cm. |
| Nr. 363 | 62 | AnAr 15159 (CTH 832). 3.2 × 2.8 cm. As far as the fragment is preserved, the script shows Middle Hittite features. |
| Nr. 364 | 62 | AnAr 15161 (CTH 832). 2.8 × 2.2 cm. |

Catalog

| <i>Tablet</i> | <i>Plate</i> | <i>Description</i> |
|----------------|--------------|--|
| Nr. 365 | 62 | AnAr 21624 (CTH 832). 4.2 × 2.6 cm. |
| Nr. 366 | 62 | AnAr 21625 (CTH 832). 2.2 × 2.7 cm. |
| Nr. 367 | 62 | AnAr 21720 (CTH 832). 5.4 × 3.1 cm. |
| Nr. 368 | 62 | AnAr 21721 (CTH 832). 2.6 × 2.1 cm. Perhaps of religious nature. |
| Nr. 369 | 62 | AnAr 21731 (CTH 832). 2.4 × 2.0 cm. |
| Nr. 370 | 62 | AnAr 21733 (CTH 832). 3.9 × 2.0 cm. |
| Nr. 371 | 62 | AnAr 21740 (CTH 832). 2.4 × 2.1 cm. Inventory text? |
| Nr. 372 | 62 | AnAr 21766 (CTH 832). 3.7 × 3.1 cm. |
| Nr. 373 | 63 | AnAr 21771 (CTH 832). 2.7 × 2.4 cm. |
| Nr. 374 | 63 | AnAr 21829 (CTH 832). 4.5 × 2.6 cm. |
| Nr. 375 | 63 | AnAr 4220 b (CTH 832). 2.9 × 2.8 cm. |
| Nr. 376 | 63 | AnAr 4220 c (CTH 832). 2.7 × 3.6 cm. |
| Nr. 377 | 63 | AnAr 4220 h (CTH 832). 2.2 × 2.6 cm. |
| Nr. 378 | 63 | AnAr 4220 k (CTH 832). 2.2 × 2.0 cm. |
| Nr. 379 | 63 | AnAr 4220 ö (CTH 832). 2.8 × 2.4 cm. |
| Nr. 380 | 63 | AnAr 68-3-65 (CTH 832). 2.6 × 2.6 cm. |
| Nr. 381 | 63 | AnAr 28-2-66 (CTH 832). 3.2 × 3.6 cm. |
| Nr. 382 | 63 | AnAr 26-2-68 (CTH 832). 4.6 × 4.4 cm. Of religious nature. |
| Nr. 383 | 64 | AnAr 26-3-68 (CTH 832). 4.7 × 3.0 cm. |
| Nr. 384 | 64 | AnAr 90-5-68 (CTH 832). 2.3 × 4.1 cm. |
| Nr. 385 | 64 | AnAr 90-7-68 (CTH 832). 2.3 × 3.0 cm. |
| Nr. 386 | 64 | AnAr 80-2-74 (CTH 832 or 500). 2.8 × 2.7 cm. Of religious nature. In line 2' [^d Minki]n and ^d Amu[nkin] are mentioned; hence, perhaps a Kizzuwatnan ritual. |
| Nr. 387 | 64 | AnAr 80-3-74 (CTH 832). 3.1 × 3.2 cm. |
| Nr. 388 | 64 | AnAr 96-3-76 (CTH 832). 3.1 × 2.5 cm. From the “Kuṣsaray” tablets. |
| Nr. 389 | 64 | AnAr 96-4-76 (CTH 832). 4.2 × 1.4 cm. From the “Kuṣsaray” tablets. |
| Nr. 390 | 64 | AnAr 96-5-76 (CTH 832). 3.8 × 2.0 cm. From the “Kuṣsaray” tablets; mentions [^m H]ešni and ^m Piḥa-A.[A] in line 7'. |

ÖZEL İSİMLER DİZİNİ / INDEX OF PROPER NAMES

TANRI İSİMLERİ / DIVINE NAMES

- Ā Nr. 17:5'
 Alawayaimi Nr. 81:(6')
 Amunki Nr. 386:(2')
 É.A² Nr. 64:3'
 Ešhaburni Nr. 231+ I 21'
 Ḫalki Nr. 117 öy./obv. 6'; Nr. 213 öy./obv. 14
 Ḫalmaššuitta Nr. 148 ay./rev. 6'
 Ḫatni Nr. 231+ I 20'
 Ḫepat Nr. 92 öy./obv. 4'; Nr. 152 öy./obv. 3'
 Ḫepat (^{URU}Ḫatti) Nr. 152 öy./obv. 4'
 Ḫepat (^{URU}Ḫurma) Nr. 152 öy./obv. 8'
 Ḫepat (^{URU}Kizzuwatna) Nr. 152 öy./obv. 9'
 Ḫepat (^{URU}Šamuḫa) Nr. 152 öy./obv. 6'
 Ḫepat (^{URU}Šanana[...]) Nr. 152 öy./obv. 7'
 Ḫepat (^{URU}Uda) Nr. 152 öy./obv. 5'
^{GU}Ḫurri Nr. 231+ I (24')
 Ḫuwaššanna Nr. 227 ay./rev. III² (5'); Nr. 228 öy./obv. (12')
 IMIN.IMIN.BI(?) Nr. 160:(4')
 Inar Nr. 178:(9')
 Išḫara Nr. 114:6'
 IŠKUR Nr. 20 öy./obv. 2'; Nr. 228 ay./rev. 10'
 IŠKUR-ub Nr. 252 öy./obv. 3', 9', ay./rev. 7
 IŠTAR Nr. 20 öy./obv. 7'; Nr. 47:(8²); Nr. 103 öy./obv. 2
 Galli Nr. 287:(3')
 Kamrušepa Nr. 243 öy./obv. (10')
 Karzi Nr. 173 öy./obv. II² 7'
 Kulitta Nr. 105:(10'); Nr. 106:2'
 Kumarbi Nr. 17:(8')
 LAMMA Nr. 91:(2'); Nr. 200:3'; Nr. 213 ay./rev. 9'; Nr. 225:2'; Nr. 243 öy./obv. 11'; Nr. 253:7'
 LUGAL-ma Nr. 231+ I 23'
 Maliya Nr. 190 öy./obv. 5'
 Mezzulla Nr. 166:(3'); Nr. 224 öy./obv. (5'); Nr. 226 ay./rev. 8', (14'), (27'')
 Minki Nr. 386:(2')
 Ninatta Nr. 105:(10'); Nr. 354:(3')²
 Ninka Nr. 120 ay./rev. 8'
 Pannunta Nr. 240:(3'), (6')

- Parga **Nr. 139** I 9'
- Bišašap̄hi **Nr. 231+** I (20')
- Šarruma bkz./see under LUGAL-ma
- Šaušga (^{URU}Ninuwa) **Nr. 249** öy./obv. II² (3'), (5')
- ^{GU}Šeri **Nr. 231+** I 24'
- Šuita **Nr. 121** öy./obv. 7'
- Taḫištanu **Nr. 139** I 8'
- Tašimaz **Nr. 139** I 5'
- Telipinu **Nr. 16:**(8'); **Nr. 120** ay./rev. (1'); **Nr. 218:**3'
- Tetešḫap/wi **Nr. 235:**(6')
- Dinu **Nr. 231+** I 31'
- Tunapi **Nr. 228** öy./obv. 1'
- U **Nr. 51** öy./obv. 12²; **Nr. 107:**2'; **Nr. 181** öy./obv. 8'; **Nr. 196** öy./obv.² I² 13'; **Nr. 215:**9'; **Nr. 226** ay./rev. 23'; **Nr. 231+** I 23'; **Nr. 244:**3'; **Nr. 285:**2'; **Nr. 298:**3'; **Nr. 308:**5'²
- U-ub **Nr. 231+** I 26', 29', 31'; **Nr. 251:**3'
- U (É-TIM) **Nr. 120** öy./obv. (2'); **Nr. 173** öy./obv. II² 3'
- U (*ḫaršiharšiyaš*) **Nr. 120** ay./rev. 12'
- U (*ḫeuwaš*) **Nr. 120** ay./rev. 14'
- U (^{URU}Kummiya) **Nr. 17:**9'
- U (^{URU}Nerik(ka)) **Nr. 194** öy./obv. II² 3'; **Nr. 226** ay./rev. 11'
- U (^{URU}Ta[...]) **Nr. 190** öy./obv. 6'
- U (^{URU}Zippalanda) **Nr. 174** ay./rev. III² (2'); **Nr. 226** ay./rev. (29'')
- UTU **Nr. 3:**(4'); **Nr. 166:**2'; **Nr. 182:**2²; **Nr. 190** öy./obv. 2'; **Nr. 224** öy./obv. 5'; **Nr. 328:**6²; **Nr. 382:**3'
- UTU (*taknaš*) **Nr. 28** öy./obv. 7'; **Nr. 30** I (11); **Nr. 31:**3'; **Nr. 152** öy./obv. (10'), (11'); **Nr. 223** II 8; **Nr. 240:**5'
- UTU (AN-E) **Nr. 316:**2'
- UTU (^{NA}ZI.KIN) **Nr. 120** ay./rev. 11'
- UTU (^{URU}Ḫimm[uwa²]) **Nr. 190** öy./obv. 4'
- UTU (^{URU}PÚ) **Nr. 118** sol kenar/left edge 2'
- ZABA₄BA₄ **Nr. 120** öy./obv. (14'); **Nr. 147:**(5'); **Nr. 342:**2'
- DA[M. ...] ya da / or NI[N. ...] **Nr. 181** öy./obv. 1'
- Eš-x-[...] ya da / or ŠIN **Nr. 118** sol kenar/left edge 2'
- Ḫ[a²...] **Nr. 374:**2'
- Ḫa-x-[...] **Nr. 182:**3'
- Ḫu-[...] **Nr. 217** öy./obv. 9'
- [...]-x-im-mu(-uš) **Nr. 92** öy./obv. 5'
- Ga-ag-ga¹-ru(-)x[...] **Nr. 120** ay./rev. 6'
- Li-[...] **Nr. 244:**5'
- Ma²-[...] **Nr. 186:**4'
- [...(-)m]a-am(-)x[...](?) **Nr. 182:**4'
- Pa-az-zi(-)[...] **Nr. 190** öy./obv. 3'
- [...]-x-pu-na **Nr. 226** ay./rev. 9'

- Ši-<me²>-ki **Nr. 92** öy./obv. 4'
 Te-ti-mu-[...]² **Nr. 92** öy./obv. 5'
 Da-x-[...] **Nr. 308:6'**
 Uš²-x-x²[...] **Nr. 228** öy./obv. 11'
 Za-x[...] **Nr. 176** öy./obv. II² 4'
 Za-a-x[...] (?) **Nr. 336:3'** (ya da *an-za-a-a[š]* okunmalıdır/or to be read *an-za-a-a[š]*)
 Zu-u-la-x[...] **Nr. 118** öy./obv. 7'

ŞAHIS İSİMLERİ / PERSONAL NAMES

- Artaya **Nr. 1** öy./obv. (46)
 Artatama **Nr. 1** öy./obv. (52)
 Artešna **Nr. 103** öy./obv. 1
 DINGIR.GE₆.LÚ **Nr. 120** ay./rev. 7'
 Eniadali **Nr. 19** + III 16'
 Ešiadali **Nr. 19** + III 17'
 Ğešni **Nr. 390:(6')**
 Impakru **Nr. 19** + III (10'), 12'
 Kešše **Nr. 18** ay./rev. 2', (4')
 Mašġuiluwa bkz./see under PÉŠ.TUR-wa
 Mege **Nr. 247** öy./obv. 2'
 Muršili **Nr. 23** ay./rev. (4'); **Nr. 312:4'**
 PÉŠ.TUR-wa **Nr. 127:2', 8', (11')**
 Piġa-A.A **Nr. 390:6'**
 Piġamuwa bkz./see under Piġa-A.A
 Tušratta **Nr. 1** öy./obv. (48)
 Uppatišipa **Nr. 121** öy./obv. 7'
 Urġi-teššub **Nr. 231**+ I 30'
 Zazalla **Nr. 247** öy./obv. 3'
 [...] -li(-in-na) **Nr. 310:5'**
 [...] -x-mu-wa(?) **Nr. 390:2'**
 [...] -^dLAMMA(?) **Nr. 390:1'**

YER İSİMLERİ / GEOGRAPHICAL NAMES

- Ailanuwa **Nr. 19** + III 14'
 Alše **Nr. 2** öy./obv. 4'
 Apzi(?) **Nr. 333** ay./rev.² 4' (ya da *kar¹-ap-zi* okunmalıdır/or to be read *kar¹-ap-zi*)
 Arinna **Nr. 7** öy./obv. (13')²; **Nr. 119:(1')**, (10'); **Nr. 378:(2')**
 Ayrıca bkz./see also under PÚ(-na)
 Ğatti **Nr. 1** öy./obv. (49); **Nr. 22:(8')**; **Nr. 152** öy./obv. 4'; **Nr. 275** öy./obv. 1'; **Nr. 333** ay./rev.² 5'
 Ğattuša **Nr. 127:(3')**
 Ğimmuwa(?) **Nr. 190** öy./obv. (4')

Ḫurri **Nr. 200**:(2')

Ḫurma **Nr. 152** öy./obv. 8'

Kalapiya **Nr. 123** öy./obv. 4'

Kaneš **Nr. 213** ay./rev. 10'

Kannuwara(?) **Nr. 378**:(3')

Karanduniya(?) **Nr. 314** ay./rev.(4')

Kargamiš **Nr. 4**:3'

Kizzuwatna **Nr. 110** öy./obv. (2'); **Nr. 152** öy./obv. (9')

KÛ.BABBAR **Nr. 292** öy./obv. 4'

Ayrıca bkz./see also under Ḫatti, Ḫattuša

Kummanni(?) **Nr. 278**:(3'); **Nr. 284**:(4')

Kummiya **Nr. 17**:(9')

Mizri **Nr. 2** öy./obv. 3'

Naruwa **Nr. 9** öy./obv. 8

Nerik(ka) **Nr. 194** öy./obv. II² 3'; **Nr. 226** ay./rev. 11'

Ninuwa **Nr. 249** öy./obv. II² 3', 5'

Partanḫila **Nr. 353** öy./obv. (3')

PÚ(-na) **Nr. 118** sol kenar/left edge 2'; **Nr. 167** öy./obv. (2')

Ayrıca bkz./see also under Arinna

Šamuḫa **Nr. 152** öy./obv. 6'

Šapparta(?) **Nr. 122** öy./obv. 5'

Dašimuwa **Nr. 232**:(2')

Dauniya **Nr. 192** sol kenar/left edge (2')

Timalata **Nr. 122** öy./obv. (2')

Tita **Nr. 18** ay./rev. 6'

Tuššilašši **Nr. 7** öy./obv. 14'

Ura **Nr. 110** öy./obv. 3'

Uda **Nr. 152** öy./obv. 5'

Zip(pa)landa **Nr. 174** ay./rev. III² (2'); **Nr. 199** öy./obv. 2; **Nr. 226** ay./rev. (29")

A-ru-ut-x(-)[...] **Nr. 7** öy./obv. 10'

Ḫa-x-[...] **Nr. 24** öy. 11'

[...]-x-i-za-aš-ta **Nr. 7** öy./obv. 15'

[...](-)x-ma-aš-ši-ja-aš **Nr. 7** öy./obv. 9'

[...-a]r-ni-ja **Nr. 7** öy./obv. 7'

Ša-na-a-n[a-...] **Nr. 152** öy./obv. 7'

Ša-na-a[p²-...] **Nr. 353** öy./obv. 5'

[...](-)x-ša-na-aš-z[i²-...](?) **Nr. 7** öy./obv. 8'

Ta-[...] **Nr. 190** öy./obv. 6'

Da-ḫa-[...] **Nr. 7** öy./obv. 12'

[...]-da-aš-ḫa-pa-aš **Nr. 7** öy./obv. 11'(?)

Ti-ú-x-[...] **Nr. 7** öy./obv. 16'

Wa-al-ku-x(-)[...] **Nr. 353** öy./obv. 4'

Za-x-[...] Nr. 7 öy./obv. 15'

DAĞ İSİMLERİ / MOUNTAIN NAMES

A²-[...] Nr. 103 öy./obv. 2

Ḫur-z[a-...] Nr. 7 öy./obv. 20'

Ḫazzi Nr. 231+ I (25')

Namni Nr. 231+ I 25'

PINAR İSMİ / SPRING NAME

Kuwannaniya Nr. 120 ay./rev. (3')

KONKORDANZ / CONCORDANCE

| ABoT II | AnAr | ABoT II | AnAr |
|---------|------------------------------------|---------|-------------------|
| 1 | 12194(+) KBo 28.111 (+) KBo 28.112 | 42 | 10589 |
| 2 | 4220 ₁ (+) KBo 28.98 | 43 | 10594 |
| 3 | 11621 a | 44 | 10602 |
| 4 | 11386 | 45 | 10868 |
| 5 | 8916 | 46 | 11498 |
| 6 | 14932 | 47 | 11501 |
| 7 | 11401 | 48 | 11503 e |
| 8 | 9722 | 49 | 11503 g |
| 9 | 12928 | 50 | 11620 b |
| 10 | 12131 d | 51 | 12171 |
| 11 | 14921 | 52 | 14916 |
| 12 | 9469 | 53 | 14989 |
| 13 | 9134 | 54 | 21813 |
| 14 | 15162 | 55 | 64-1-65 |
| 15 | 21630 | 56 | 14973 |
| 16 | 80-1-74 | 57 | 4220 r |
| 17 | 96-6-76 | 58 | 14951 |
| 18 | 12165 | 59 | 6992 |
| 19 | 12164+ KUB 36.67 | 60 | 8360 ₁ |
| 20 | 10869 | 61 | 8365 f |
| 21 | 11621 c | 62 | 9138 |
| 22 | 11398 | 63 | 9166 |
| 23 | 12177 | 64 | 9465 |
| 24 | 10591 | 65 | 9715 |
| 25 | 12183 | 66 | 10322 |
| 26 | 14915(+) KUB 58.79 | 67 | 10592 |
| 27 | 12131 b | 68 | 10598 |
| 28 | 11613 a | 69 | 10603 |
| 29 | 11246 a | 70 | 11246 d |
| 30 | 21626+ KBo 10.45 | 71 | 11246 e |
| 31 | 11503 a+d | 72 | 11391 |
| 32 | 14966 | 73 | 11396 |
| 33 | 8926 | 74 | 11614 a |
| 34 | 4220 m | 75 | 11616 b |
| 35 | 4220 o+s | 76 | 14453 |
| 36 | 6993 | 77 | 12131 f |
| 37 | 8357 | 78 | 12131 h |
| 38 | 9146 | 79 | 12131 k |
| 39 | 10308 | 80 | 14931 |
| 40 | 10312 | 81 | 14933 |
| 41 | 10320 | 82 | 14958 |

KONKORDANZ / CONCORDANCE

| ABoT II | AnAr | ABoT II | AnAr |
|---------|-------------------|---------|------------------|
| 83 | 14965 | 127 | 10609 |
| 84 | 14994 | 128 | 10872 |
| 85 | 15155 | 129 | 8357 a |
| 86 | 21631 | 130 | 8840 |
| 87 | 21730 | 131 | 9163 |
| 88 | 4220 e | 132 | 11246 l |
| 89 | 28-1-66 | 133 | 11387 |
| 90 | 16-5-68 | 134 | 12174 |
| 91 | 80-4-74 | 135 | 12216 |
| 92 | 9464 | 136 | 10757 |
| 93 | 11618 | 137 | 15151 + KUB 5.17 |
| 94 | 6984 | 138 | 90-6-68 |
| 95 | 6987 | 139 | 70-1-76 |
| 96 | 7007 | 140 | 10285 |
| 97 | 8358 a+b | 141 | 12157 |
| 98 | 8360 a | 142 | 8360 i |
| 99 | 8363 | 143 | 96-2-76 |
| 100 | 8847 | 144 | 16-6-68 |
| 101 | 9157 + KBo 41.114 | 145 | 9723 |
| 102 | 10310 | 146 | 12156 |
| 103 | 10313 | 147 | 11502 c |
| 104 | 10587 | 148 | 10311 |
| 105 | 10865 | 149 | 10300 |
| 106 | 11246 g | 150 | 12176 |
| 107 | 11388 | 151 | 4220 d |
| 108 | 11408 | 152 | 70-2-76 |
| 109 | 11620 a | 153 | 10299 |
| 110 | 14919 | 154 | 3137 |
| 111 | 14955 | 155 | 6995 |
| 112 | 90-4-68 | 156 | 8357 f |
| 113 | 11615 | 157 | 8360 c + ğ + m |
| 114 | 14922 | 158 | 8360 f |
| 115 | 6964 + 6991 | 159 | 8360 h |
| 116 | 10326 | 160 | 8360 n + s + ş |
| 117 | 10606 | 161 | 8365 b |
| 118 | 10871 | 162 | 8857 |
| 119 | 11499 | 163 | 8911 |
| 120 | 14913 | 164 | 8919 |
| 121 | 3544 | 165 | 9145 |
| 122 | 10315 | 166 | 9716 |
| 123 | 11613 c | 167 | 9720 |
| 124 | 14920 | 168 | 9730 |
| 125 | 11407 | 169 | 10301 |
| 126 | 8357 b+c+d+e+g+h | 170 | 10309 |

KONKORDANZ / CONCORDANCE

| ABoT II | AnAr | ABoT II | AnAr |
|---------|----------|---------|------------------------------|
| 171 | 10325 | 215 | 16-2-68 |
| 172 | 10588 | 216 | 16-3-68 |
| 173 | 10593 | 217 | 16-4-68 + KBo 54.222 |
| 174 | 10596 | 218 | 16-8-68 |
| 175 | 10597 | 219 | 16-9-68 |
| 176 | 10604 | 220 | 16-10-68 |
| 177 | 10611 | 221 | 16-11-68 |
| 178 | 10758 | 222 | 90-2-68 |
| 179 | 10866 | 223 | 87-2-06 |
| 180 | 11246 h | 224 | 4038 |
| 181 | 11288 a | 225 | 11619 b |
| 182 | 11288 b | 226 | 11202 |
| 183 | 11385 b | 227 | 12131 a |
| 184 | 11402 a | 228 | 10307 (+) KBo 29.130 |
| 185 | 11503 b | 229 | 26-1-68 |
| 186 | 11504 | 230 | 16-7-68 |
| 187 | 11619 a | 231 | 21629 + KBo 11.5 + KBo 11.58 |
| 188 | 11621 b | 232 | 9150 |
| 189 | 12166 | 233 | 12168 |
| 190 | 12169 | 234 | 3136 |
| 191 | 12178 | 235 | 10610 |
| 192 | 12186 | 236 | 12175 |
| 193 | 12188 | 237 | 11502 b |
| 194 | 14839 b | 238 | 8918 |
| 195 | 14839 c | 239 | 11621 d + g |
| 196 | 14923 | 240 | 14917 |
| 197 | 14926 | 241 | 14839 a |
| 198 | 14927 | 242 | 14914 |
| 199 | 14928 | 243 | 9251 |
| 200 | 14936 | 244 | 12170 |
| 201 | 14939 | 245 | 10319 |
| 202 | 14942 | 246 | 12131 c |
| 203 | 14967 | 247 | 42-2-66 |
| 204 | 14970 | 248 | 14918 |
| 205 | 14971 | 249 | 10318 |
| 206 | 14972 | 250 | 10595 |
| 207 | 14984 | 251 | 11616 a |
| 208 | 15160 | 252 | 12155 |
| 209 | 21627 | 253 | 8915 |
| 210 | 21632 | 254 | 8917 |
| 211 | 21633 | 255 | 9167 |
| 212 | 28-3-66 | 256 | 10321 |
| 213 | 151-1-67 | 257 | 8360 d |
| 214 | 16-1-68 | 258 | 10873 |

KONKORDANZ / CONCORDANCE

| ABoT II | AnAr | ABoT II | AnAr |
|---------|----------------------|---------|--------------------|
| 259 | 11246 ₁ | 303 | 9470 |
| 260 | 11617 _b | 304 | 9718 |
| 261 | 11616 _c | 305 | 9719 |
| 262 | 11619 _{c+e} | 306 | 9728 |
| 263 | 14935 | 307 | 9729 |
| 264 | 6966 | 308 | 9731 |
| 265 | 6968 | 309 | 9732 |
| 266 | 6988 | 310 | 10314 |
| 267 | 6996 | 311 | 10316 |
| 268 | 7002 | 312 | 10317 |
| 269 | 7004 | 313 | 10323 |
| 270 | 8354 | 314 | 10324 |
| 271 | 8355 | 315 | 10601 _a |
| 272 | 8358 _c | 316 | 10601 _b |
| 273 | 8360 _b | 317 | 10607 |
| 274 | 8360 _ç | 318 | 10608 |
| 275 | 8360 _e | 319 | 10759 |
| 276 | 8360 _g | 320 | 11240 _a |
| 277 | 8360 _j | 321 | 11240 _b |
| 278 | 8360 _k | 322 | 11246 _f |
| 279 | 8360 _r | 323 | 11246 _i |
| 280 | 8364 | 324 | 11385 _a |
| 281 | 8365 _a | 325 | 11390 |
| 282 | 8365 _ç | 326 | 11392 |
| 283 | 8365 _ğ | 327 | 11393 |
| 284 | 8844 _a | 328 | 11404 |
| 285 | 8844 _c | 329 | 11500 |
| 286 | 8845 | 330 | 11617 _a |
| 287 | 8846 | 331 | 11621 _e |
| 288 | 8850 | 332 | 12131 _g |
| 289 | 8852 | 333 | 12163 |
| 290 | 8853 | 334 | 12180 |
| 291 | 8856 | 335 | 12181 |
| 292 | 8913 | 336 | 12182 |
| 293 | 8920 | 337 | 12189 |
| 294 | 8921 | 338 | 12196 |
| 295 | 8922 | 339 | 12197 |
| 296 | 9143 | 340 | 14455 |
| 297 | 9144 | 341 | 14924 |
| 298 | 9460 | 342 | 14925 |
| 299 | 9461 | 343 | 14929 |
| 300 | 9462 | 344 | 14930 |
| 301 | 9463 | 345 | 14937 |
| 302 | 9467 | 346 | 14938 |

KONKORDANZ / CONCORDANCE

| ABoT II | AnAr | ABoT II | AnAr |
|---------|-------|---------|---------|
| 347 | 14941 | 369 | 21731 |
| 348 | 14944 | 370 | 21733 |
| 349 | 14947 | 371 | 21740 |
| 350 | 14954 | 372 | 21766 |
| 351 | 14957 | 373 | 21771 |
| 352 | 14964 | 374 | 21829 |
| 353 | 14968 | 375 | 4220 b |
| 354 | 14969 | 376 | 4220 c |
| 355 | 14974 | 377 | 4220 h |
| 356 | 14975 | 378 | 4220 k |
| 357 | 14978 | 379 | 4220 ö |
| 358 | 14981 | 380 | 68-3-65 |
| 359 | 14982 | 381 | 28-2-66 |
| 360 | 14983 | 382 | 26-2-68 |
| 361 | 15154 | 383 | 26-3-68 |
| 362 | 15156 | 384 | 90-5-68 |
| 363 | 15159 | 385 | 90-7-68 |
| 364 | 15161 | 386 | 80-2-74 |
| 365 | 21624 | 387 | 80-3-74 |
| 366 | 21625 | 388 | 96-3-76 |
| 367 | 21720 | 389 | 96-4-76 |
| 368 | 21721 | 390 | 96-5-76 |

KONKORDANZ / CONCORDANCE

| AnAr | ABoT II | AnAr | ABoT II |
|----------------------------|---------|--------------------|---------|
| 3136 | 234 | 8360 h | 159 |
| 3137 | 154 | 8360 i | 60 |
| 3544 | 121 | 8360 j | 142 |
| 4038 | 224 | 8360 k | 277 |
| 4220 b | 375 | 8360 l | 278 |
| 4220 c | 376 | 8360 m + n + o + p | 160 |
| 4220 d | 151 | 8360 r | 279 |
| 4220 e | 88 | 8363 | 99 |
| 4220 h | 377 | 8364 | 280 |
| 4220 i (+) KBo 28.98 | 2 | 8365 a | 281 |
| 4220 k | 378 | 8365 b | 161 |
| 4220 m | 34 | 8365 ç | 282 |
| 4220 o + s | 35 | 8365 f | 61 |
| 4220 ö | 379 | 8365 ğ | 283 |
| 4220 r | 57 | 8840 | 130 |
| 6964 + 6991 | 115 | 8844 a | 284 |
| 6966 | 264 | 8844 c | 285 |
| 6968 | 265 | 8845 | 286 |
| 6984 | 94 | 8846 | 287 |
| 6987 | 95 | 8847 | 100 |
| 6988 | 266 | 8850 | 288 |
| 6992 | 59 | 8852 | 289 |
| 6993 | 36 | 8853 | 290 |
| 6995 | 155 | 8856 | 291 |
| 6996 | 267 | 8857 | 162 |
| 7002 | 268 | 8911 | 163 |
| 7004 | 269 | 8913 | 292 |
| 7007 | 96 | 8915 | 253 |
| 8354 | 270 | 8916 | 5 |
| 8355 | 271 | 8917 | 254 |
| 8357 | 37 | 8918 | 238 |
| 8357 a | 129 | 8919 | 164 |
| 8357 b + c + d + e + g + h | 126 | 8920 | 293 |
| 8357 f | 156 | 8921 | 294 |
| 8358 a + b | 97 | 8922 | 295 |
| 8358 c | 272 | 8926 | 33 |
| 8360 a | 98 | 9134 | 13 |
| 8360 b | 273 | 9138 | 62 |
| 8360 c + ğ + m | 157 | 9143 | 296 |
| 8360 ç | 274 | 9144 | 297 |
| 8360 d | 257 | 9145 | 165 |
| 8360 e | 275 | 9146 | 38 |
| 8360 f | 158 | 9150 | 232 |
| 8360 g | 276 | 9157 + KBo 41.114 | 101 |

KONKORDANZ / CONCORDANCE

| AnAr | ABoT II | AnAr | ABoT II |
|----------------------|---------|---------|---------|
| 9163 | 131 | 10322 | 66 |
| 9166 | 63 | 10323 | 313 |
| 9167 | 255 | 10324 | 314 |
| 9251 | 243 | 10325 | 171 |
| 9460 | 298 | 10326 | 116 |
| 9461 | 299 | 10587 | 104 |
| 9462 | 300 | 10588 | 172 |
| 9463 | 301 | 10589 | 42 |
| 9464 | 92 | 10591 | 24 |
| 9465 | 64 | 10592 | 67 |
| 9467 | 302 | 10593 | 173 |
| 9469 | 12 | 10594 | 43 |
| 9470 | 303 | 10595 | 250 |
| 9715 | 65 | 10596 | 174 |
| 9716 | 166 | 10597 | 175 |
| 9718 | 304 | 10598 | 68 |
| 9719 | 305 | 10601 a | 315 |
| 9720 | 167 | 10601 b | 316 |
| 9722 | 8 | 10602 | 44 |
| 9723 | 145 | 10603 | 69 |
| 9728 | 306 | 10604 | 176 |
| 9729 | 307 | 10606 | 117 |
| 9730 | 168 | 10607 | 317 |
| 9731 | 308 | 10608 | 318 |
| 9732 | 309 | 10609 | 127 |
| 10285 | 140 | 10610 | 235 |
| 10299 | 153 | 10611 | 177 |
| 10300 | 149 | 10757 | 136 |
| 10301 | 169 | 10758 | 178 |
| 10307 (+) KBo 29.130 | 228 | 10759 | 319 |
| 10308 | 39 | 10865 | 105 |
| 10309 | 170 | 10866 | 179 |
| 10310 | 102 | 10868 | 45 |
| 10311 | 148 | 10869 | 20 |
| 10312 | 40 | 10871 | 118 |
| 10313 | 103 | 10872 | 128 |
| 10314 | 310 | 10873 | 258 |
| 10315 | 122 | 11202 | 226 |
| 10316 | 311 | 11240 a | 320 |
| 10317 | 312 | 11240 b | 321 |
| 10318 | 249 | 11246 a | 29 |
| 10319 | 245 | 11246 d | 70 |
| 10320 | 41 | 11246 e | 71 |
| 10321 | 256 | 11246 f | 322 |

KONKORDANZ / CONCORDANCE

| AnAr | ABoT II | AnAr | ABoT II |
|-------------|---------|-------------------------------------|---------|
| 11246 g | 106 | 11619 a | 187 |
| 11246 h | 180 | 11619 b | 225 |
| 11246 i | 259 | 11619 c + e | 262 |
| 11246 i | 323 | 11620 a | 109 |
| 11246 l | 132 | 11620 b | 50 |
| 11288 a | 181 | 11621 a | 3 |
| 11288 b | 182 | 11621 b | 188 |
| 11385 a | 324 | 11621 c | 21 |
| 11385 b | 183 | 11621 d + g | 239 |
| 11386 | 4 | 11621 e | 331 |
| 11387 | 133 | 12131 a | 227 |
| 11388 | 107 | 12131 b | 27 |
| 11390 | 325 | 12131 c | 246 |
| 11391 | 72 | 12131 d | 10 |
| 11392 | 326 | 12131 f | 77 |
| 11393 | 327 | 12131 g | 332 |
| 11396 | 73 | 12131 h | 78 |
| 11398 | 22 | 12131 k | 79 |
| 11401 | 7 | 12155 | 252 |
| 11402 a | 184 | 12156 | 146 |
| 11404 | 328 | 12157 | 141 |
| 11407 | 125 | 12163 | 333 |
| 11408 | 108 | 12164 + KUB 36.67 | 19 |
| 11498 | 46 | 12165 | 18 |
| 11499 | 119 | 12166 | 189 |
| 11500 | 329 | 12168 | 233 |
| 11501 | 47 | 12169 | 190 |
| 11502 b | 237 | 12170 | 244 |
| 11502 c | 147 | 12171 | 51 |
| 11503 a + d | 31 | 12174 | 134 |
| 11503 b | 185 | 12175 | 236 |
| 11503 e | 48 | 12176 | 150 |
| 11503 g | 49 | 12177 | 23 |
| 11504 | 186 | 12178 | 191 |
| 11613 a | 28 | 12180 | 334 |
| 11613 c | 123 | 12181 | 335 |
| 11614 a | 74 | 12182 | 336 |
| 11615 | 113 | 12183 | 25 |
| 11616 a | 251 | 12186 | 192 |
| 11616 b | 75 | 12188 | 193 |
| 11616 c | 261 | 12189 | 337 |
| 11617 a | 330 | 12194 (+) KBo 28.111 (+) KBo 28.112 | 1 |
| 11617 b | 260 | 12196 | 338 |
| 11618 | 93 | 12197 | 339 |

KONKORDANZ / CONCORDANCE

| AnAr | ABoT II | AnAr | ABoT II |
|---------------------|---------|------------------------------|---------|
| 12216 | 135 | 14966 | 32 |
| 12928 | 9 | 14967 | 203 |
| 14453 | 76 | 14968 | 353 |
| 14455 | 340 | 14969 | 354 |
| 14839 a | 241 | 14970 | 204 |
| 14839 b | 194 | 14971 | 205 |
| 14839 c | 195 | 14972 | 206 |
| 14913 | 120 | 14973 | 56 |
| 14914 | 242 | 14974 | 355 |
| 14915 (+) KUB 58.79 | 26 | 14975 | 356 |
| 14916 | 52 | 14978 | 357 |
| 14917 | 240 | 14981 | 358 |
| 14918 | 248 | 14982 | 359 |
| 14919 | 110 | 14983 | 360 |
| 14920 | 124 | 14984 | 207 |
| 14921 | 11 | 14989 | 53 |
| 14922 | 114 | 14994 | 84 |
| 14923 | 196 | 15151 (+) KUB 5.17 | 137 |
| 14924 | 341 | 15154 | 361 |
| 14925 | 342 | 15155 | 85 |
| 14926 | 197 | 15156 | 362 |
| 14927 | 198 | 15159 | 363 |
| 14928 | 199 | 15160 | 208 |
| 14929 | 343 | 15161 | 364 |
| 14930 | 344 | 15162 | 14 |
| 14931 | 80 | 21624 | 365 |
| 14932 | 6 | 21625 | 366 |
| 14933 | 81 | 21626 + KBo 10.45 | 30 |
| 14935 | 263 | 21627 | 209 |
| 14936 | 200 | 21629 + KBo 11.5 + KBo 11.58 | 231 |
| 14937 | 345 | 21630 | 15 |
| 14938 | 346 | 21631 | 86 |
| 14939 | 201 | 21632 | 210 |
| 14941 | 347 | 21633 | 211 |
| 14942 | 202 | 21720 | 367 |
| 14944 | 348 | 21721 | 368 |
| 14947 | 349 | 21730 | 87 |
| 14951 | 58 | 21731 | 369 |
| 14954 | 350 | 21733 | 370 |
| 14955 | 111 | 21740 | 371 |
| 14957 | 351 | 21766 | 372 |
| 14958 | 82 | 21771 | 373 |
| 14964 | 352 | 21813 | 54 |
| 14965 | 83 | 21829 | 374 |

KONKORDANZ / CONCORDANCE

| AnAr | ABoT II | AnAr | ABoT II |
|----------------------|---------|---------|---------|
| 64-1-65 | 55 | 26-2-68 | 382 |
| 68-3-65 | 380 | 26-3-68 | 383 |
| 28-1-66 | 89 | 90-2-68 | 222 |
| 28-2-66 | 381 | 90-4-68 | 112 |
| 28-3-66 | 212 | 90-5-68 | 384 |
| 42-2-66 | 247 | 90-6-68 | 138 |
| 151-1-67 | 213 | 90-7-68 | 385 |
| 16-1-68 | 214 | 80-1-74 | 16 |
| 16-2-68 | 215 | 80-2-74 | 386 |
| 16-3-68 | 216 | 80-3-74 | 387 |
| 16-4-68 + KBo 54.222 | 217 | 80-4-74 | 91 |
| 16-5-68 | 90 | 70-1-76 | 139 |
| 16-6-68 | 144 | 70-2-76 | 152 |
| 16-7-68 | 230 | 96-2-76 | 143 |
| 16-8-68 | 218 | 96-3-76 | 388 |
| 16-9-68 | 219 | 96-4-76 | 389 |
| 16-10-68 | 220 | 96-5-76 | 390 |
| 16-11-68 | 221 | 96-6-76 | 17 |
| 26-1-68 | 229 | 87-2-06 | 223 |

LEVHALAR

PLATES

Text 1

AnAr 12194
(+) KBo 28.111 (+)KBo 28.112
önyüz / obverse

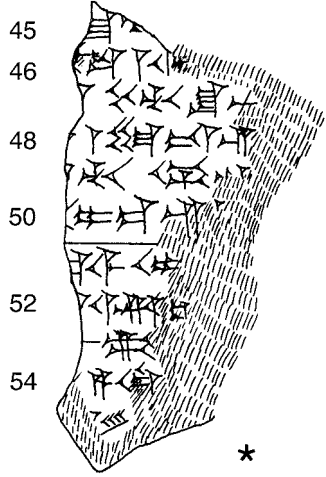

Text 2

AnAr 4220₁ (+) KBo 28.98
önyüz / obverse

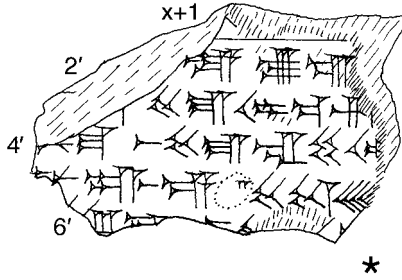

Text 3

AnAr 11621 a

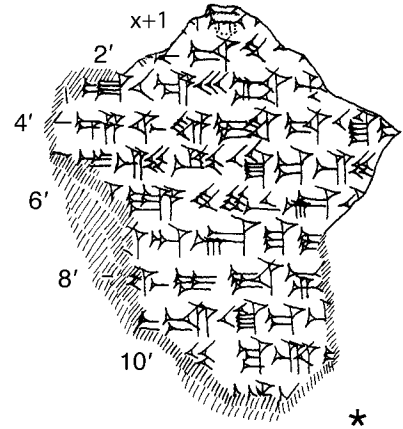

Text 4

AnAr 11386

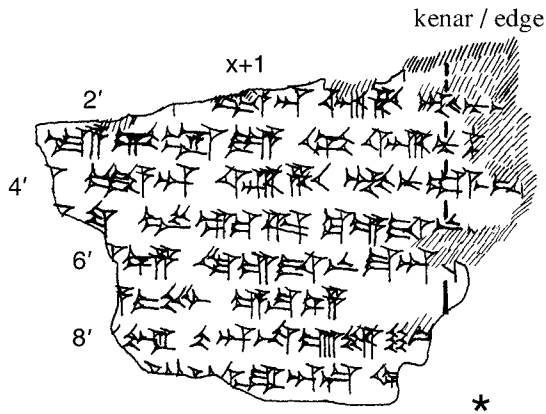

Text 5

AnAr 8916
önyüz / obverse

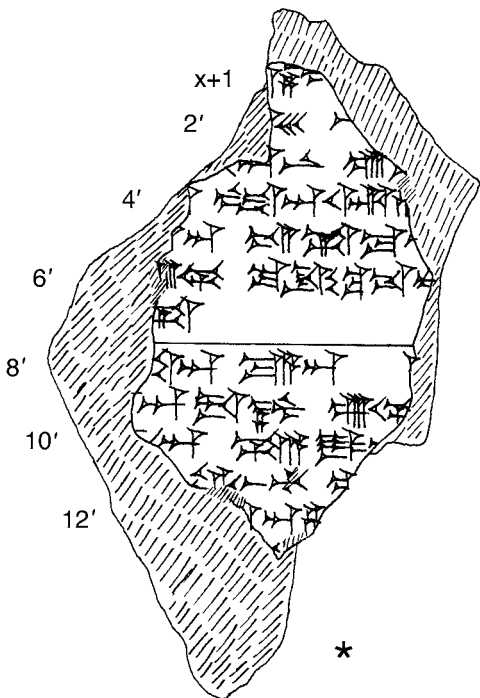

Text 6

AnAr 14932

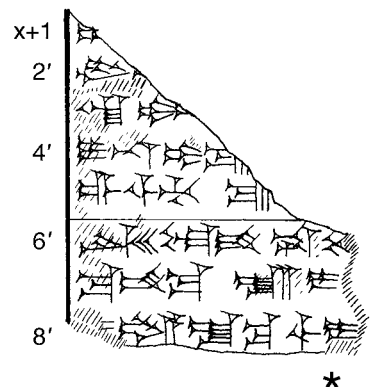

Text 7

AnAr 11401
önyüz / obverse

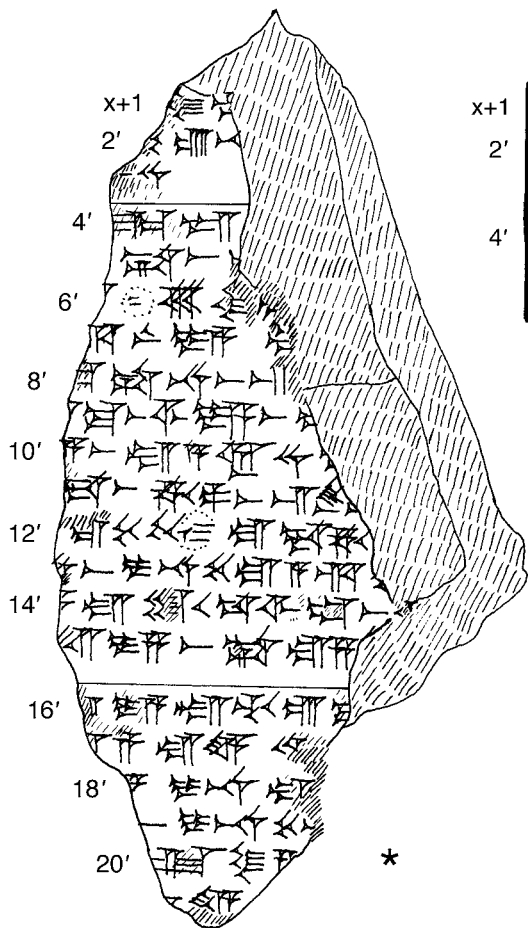

Text 8

AnAr 9722

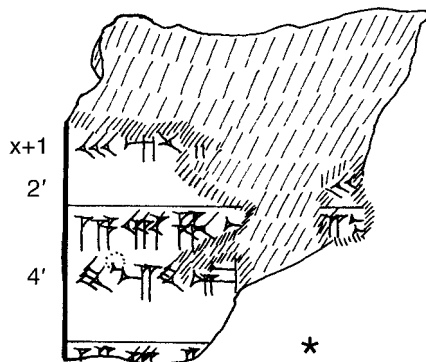

Text 9

AnAr 12928
önyüz / obverse



arkayüz / reverse

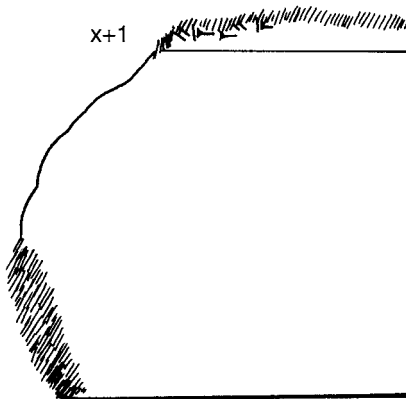

Text 10

AnAr 12131 d

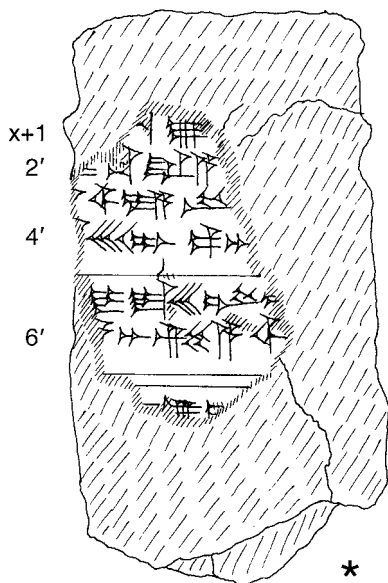

Text 11

AnAr 14921

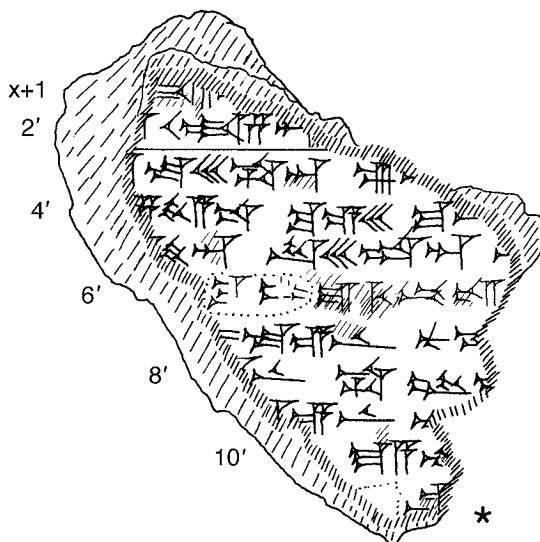

Text 12

AnAr 9469
arkayüz? / reverse?

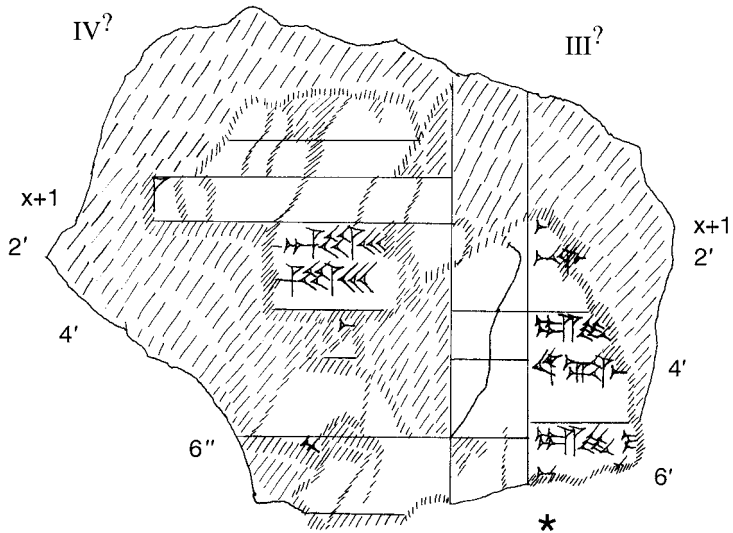

Text 13

AnAr 9134
önyüz / obverse

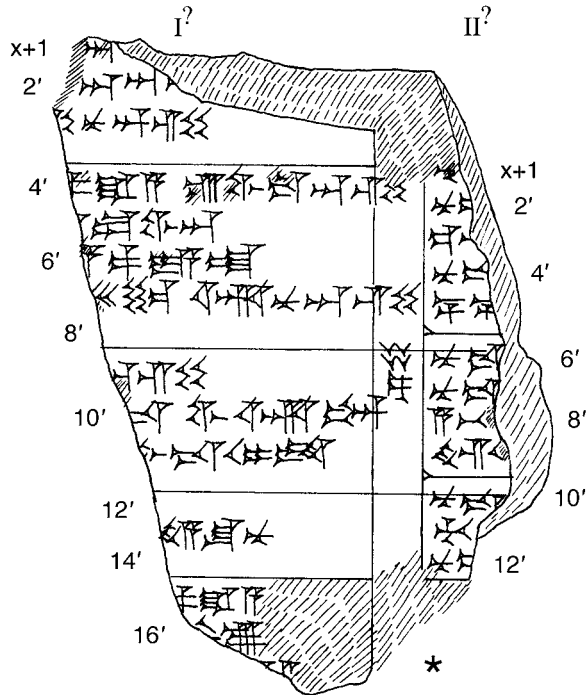

Text 15

AnAr 21630
önyüz / obverse

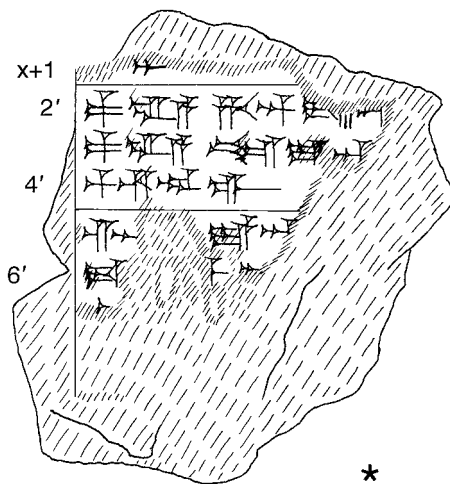

Text 14

AnAr 15162
önyüz / obverse

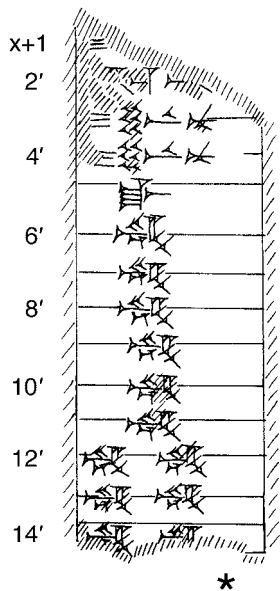

Text 16

AnAr 80-1-74

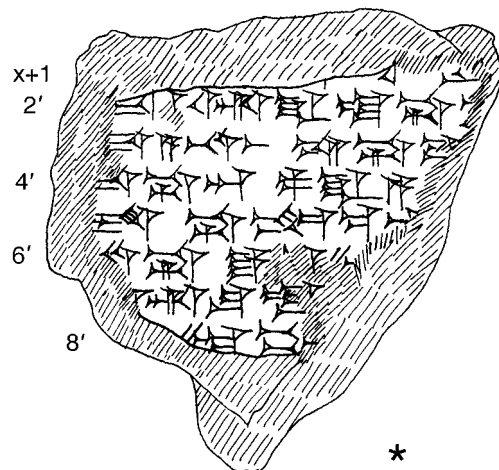

Text 17

AnAr 96-6-76

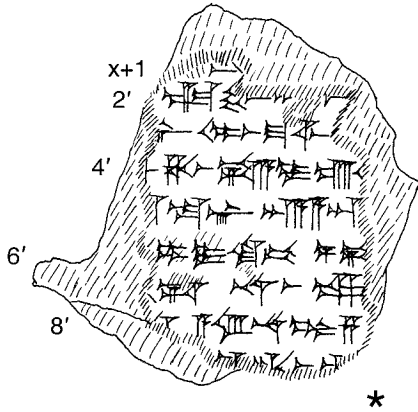

Text 18

AnAr 12165
arkayüz / reverse

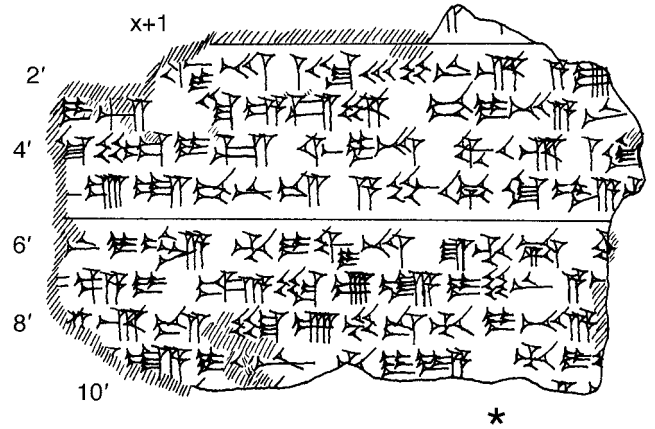

Text 19

AnAr 12164 + KUB 36.67
arkayüz / reverse

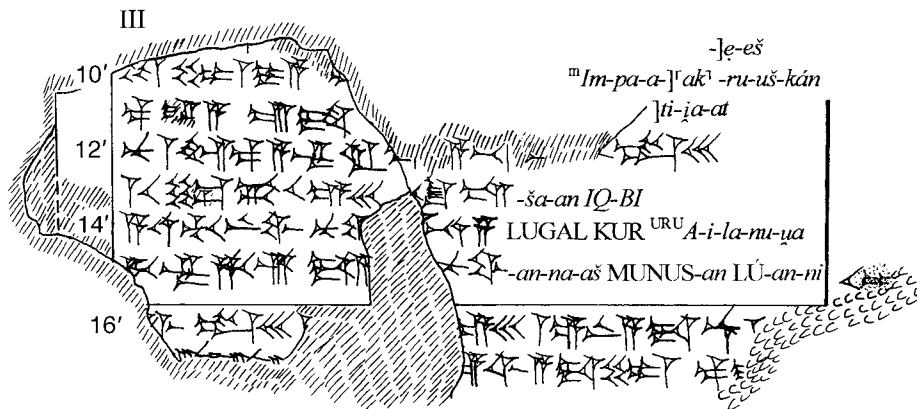

Text 21

AnAr 11621 c

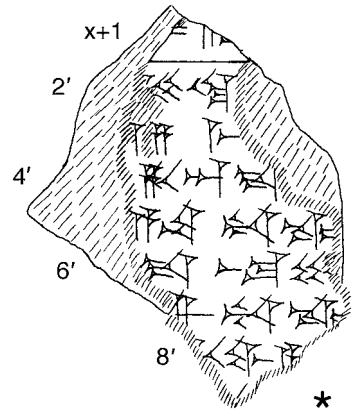

Text 20

AnAr 10869
önyüz / obverse

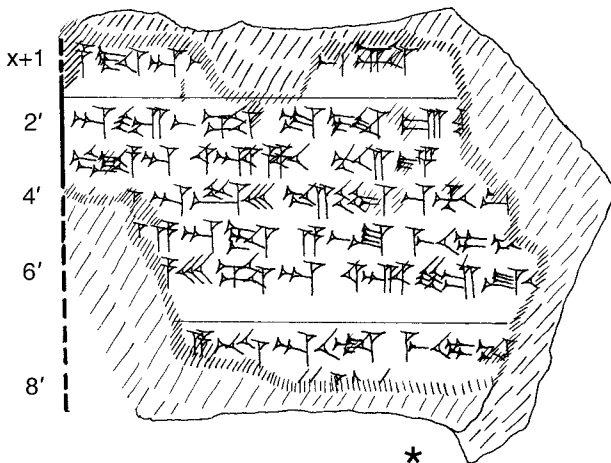

Text 22

AnAr 11398

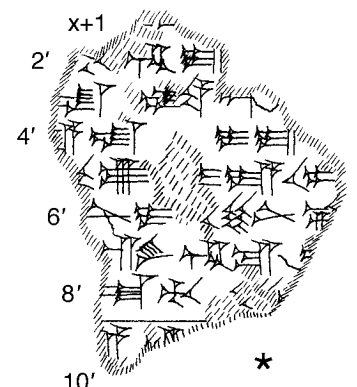

Text 24

AnAr 10591

önyüz / obverse

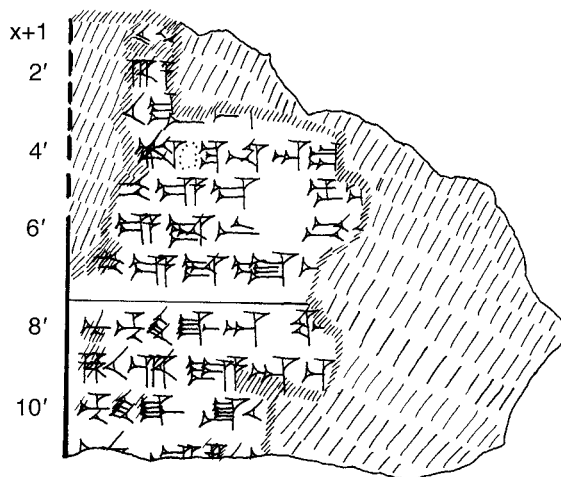

arkayüz / reverse

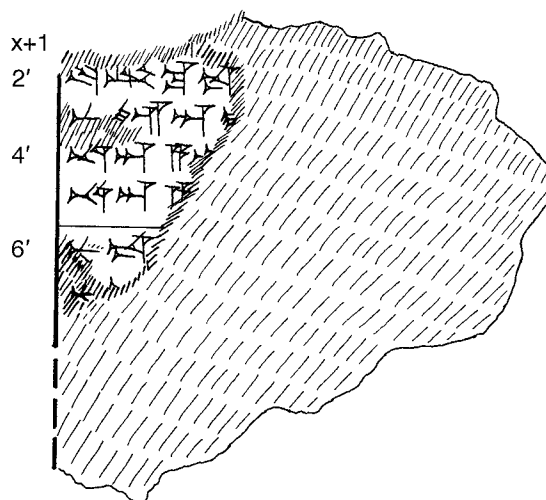

Text 23

AnAr 12177

arkayüz / reverse

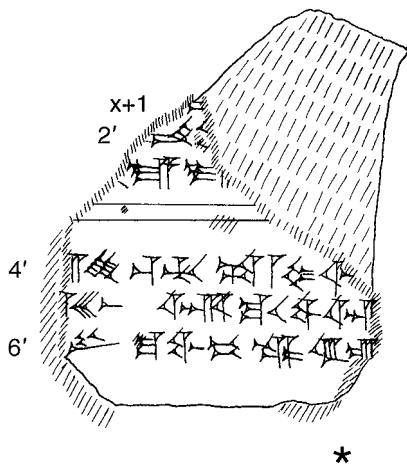

Text 26

AnAr 14915 (+) KUB 58.79

önyüz / obverse

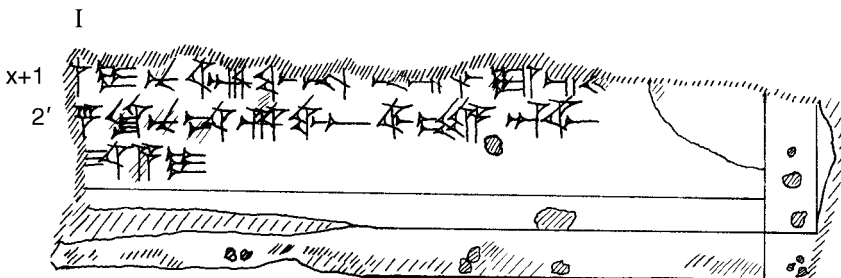

Text 25

AnAr 12183

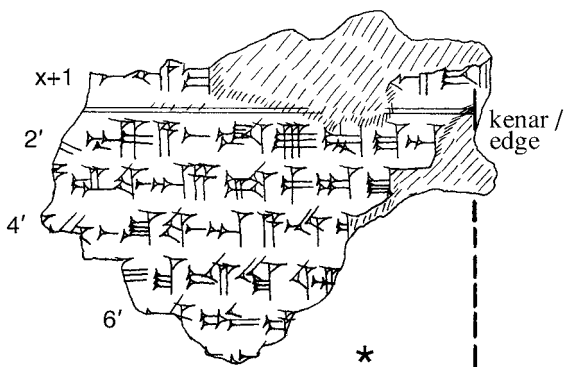

arkayüz / reverse

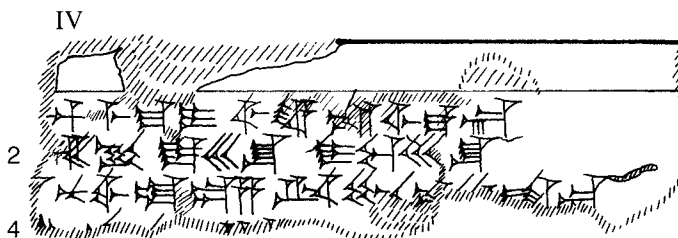

Text 27

AnAr 12131 b

önyüz / obverse

arkayüz / reverse

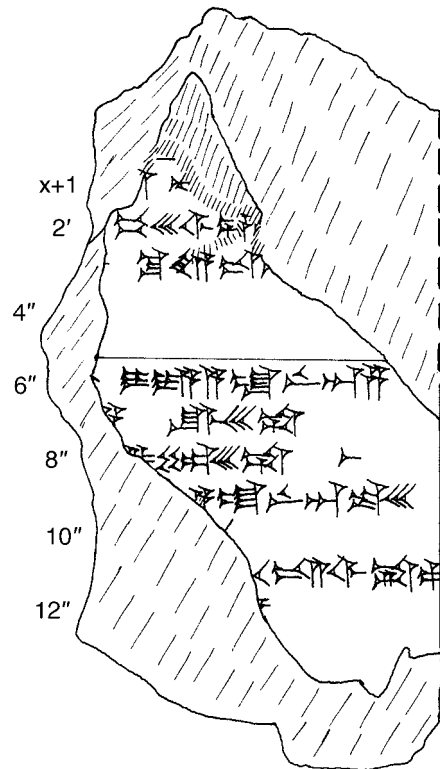
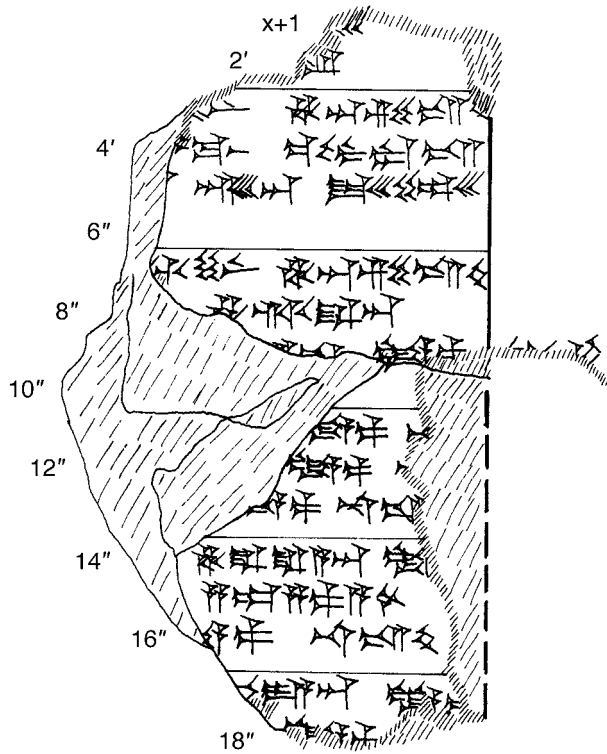

Text 28

AnAr 11613 a

önyüz / obverse

arkayüz / reverse

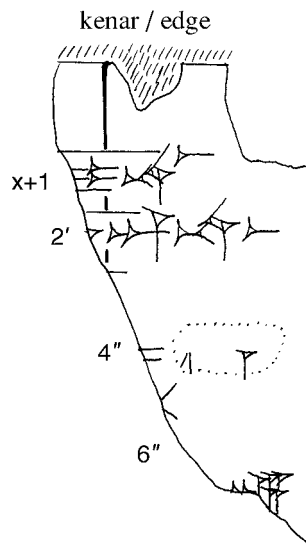
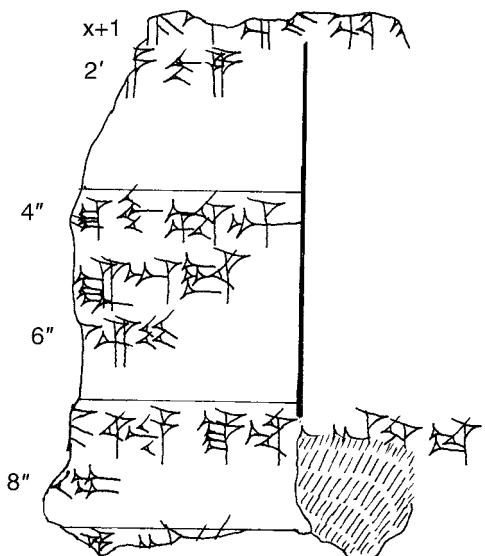

Text 29

AnAr 11246 a

arkayüz? / reverse?

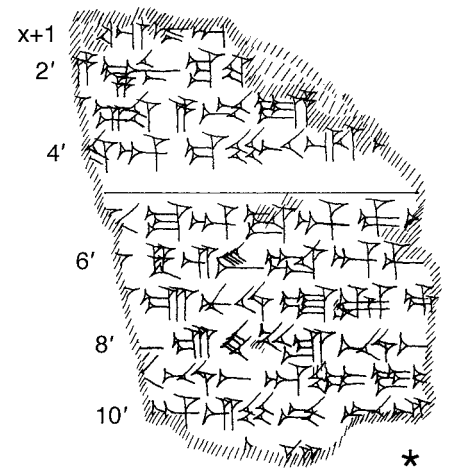

Text 30

AnAr 21626 + KBo 10.45

önyüz / obverse

arkayüz / reverse

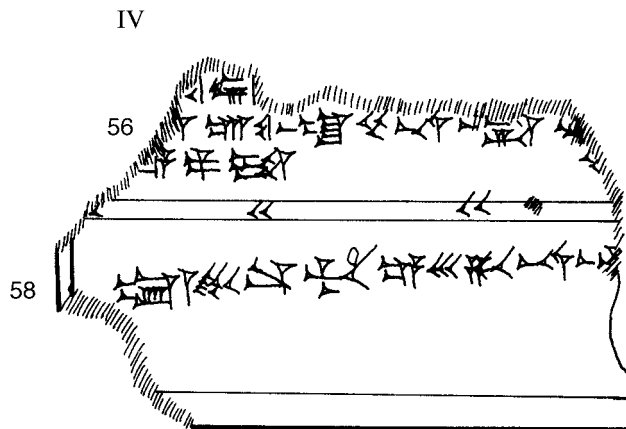
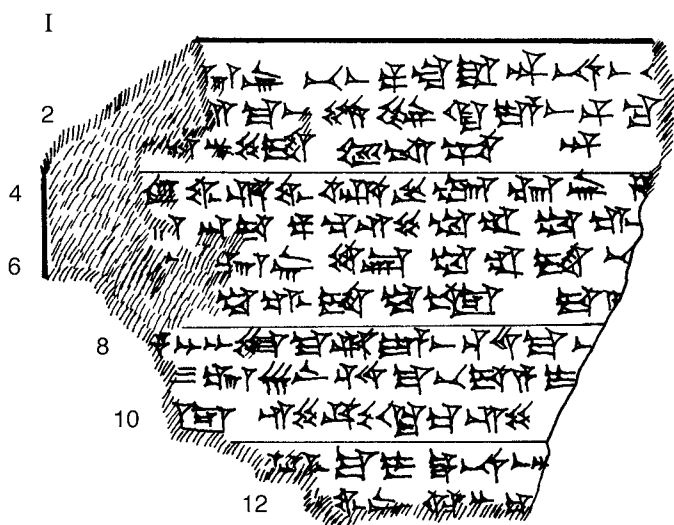

Text 31

AnAr 11503 a+d

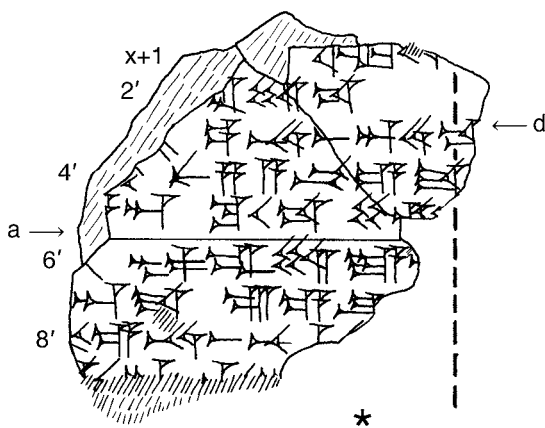

Text 32

AnAr 14966
önyüz / obverse

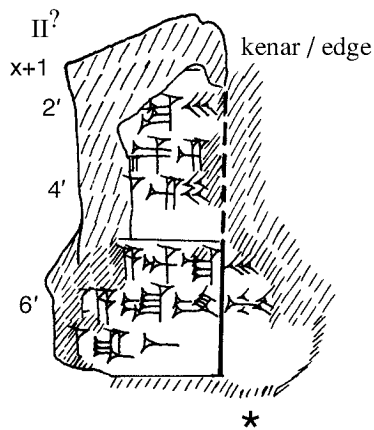

Text 33

AnAr 8926

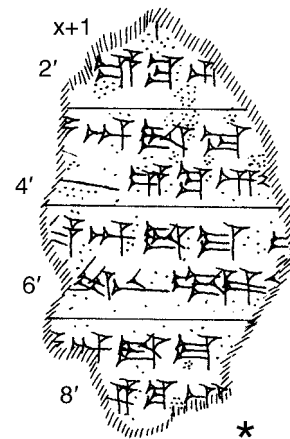

Text 35

AnAr 4220 o+s

Text 34

AnAr 4220 m

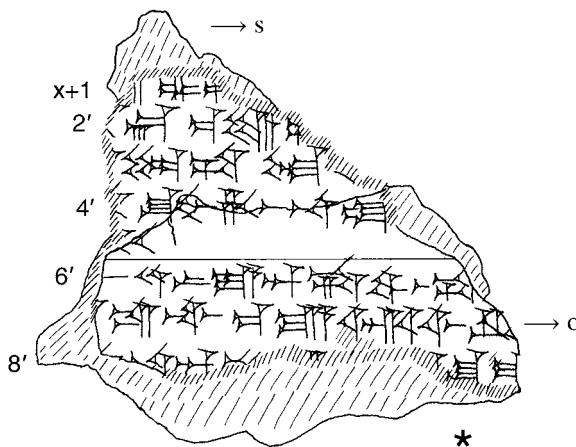
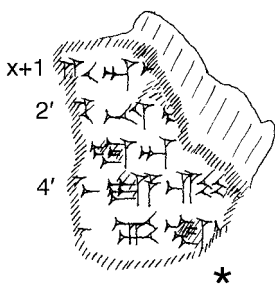

Text 36

AnAr 6993

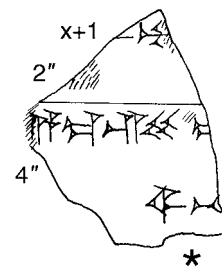

Text 37

AnAr 8357

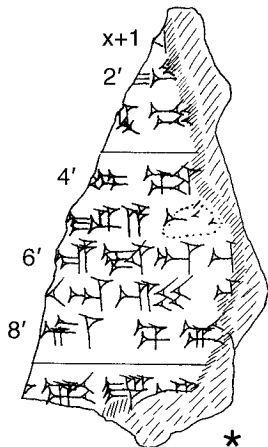

Text 38

AnAr 9146

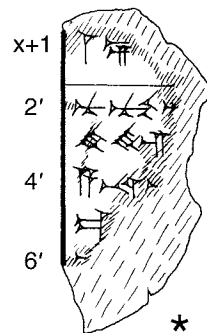

Text 39

AnAr 10308
arkayüz / reverse

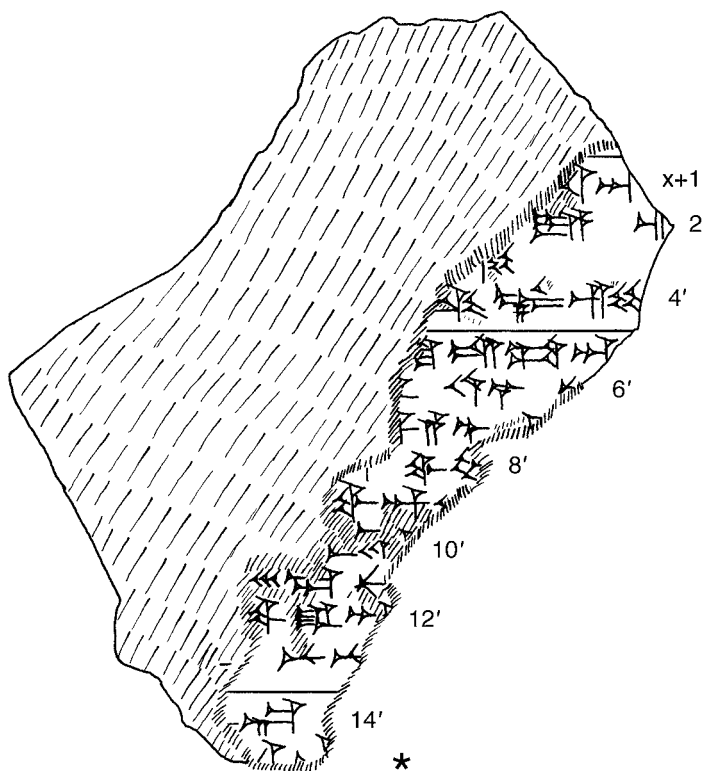

Text 40

AnAr 10312
arkayüz / reverse

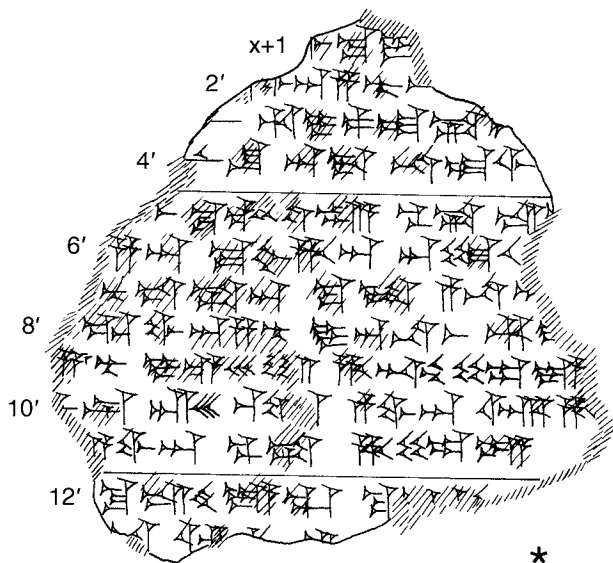

Text 41

AnAr 10320

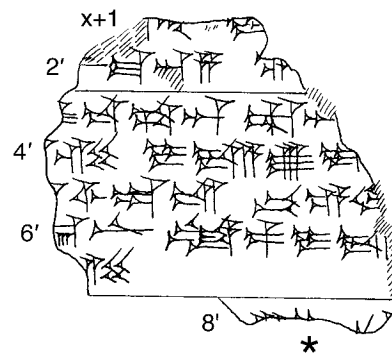

Text 42

AnAr 10589

önyüz? / obverse?

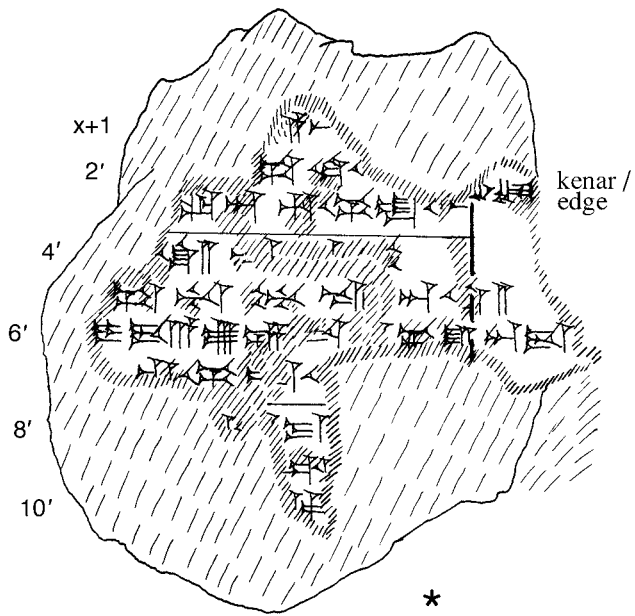

Text 43

AnAr 10594

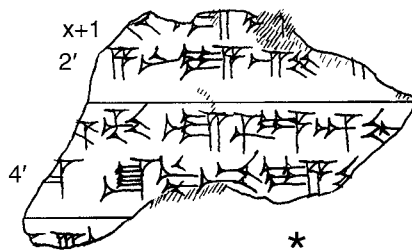

Text 44

AnAr 10602

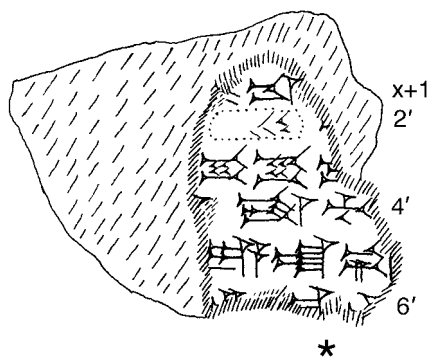

Text 45

AnAr 10868

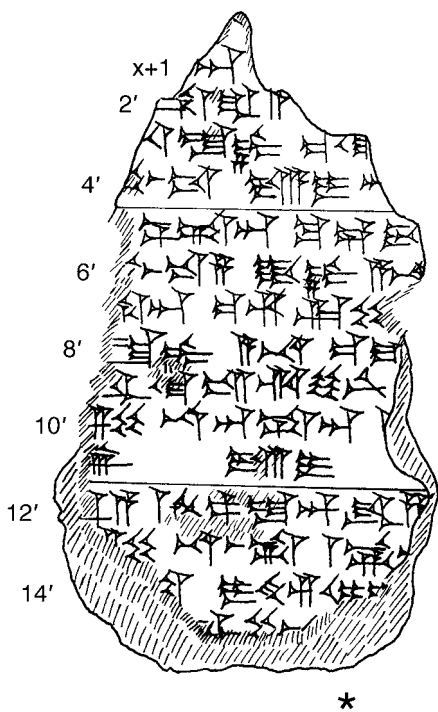

Text 46

AnAr 11498

önyüz? / obverse?

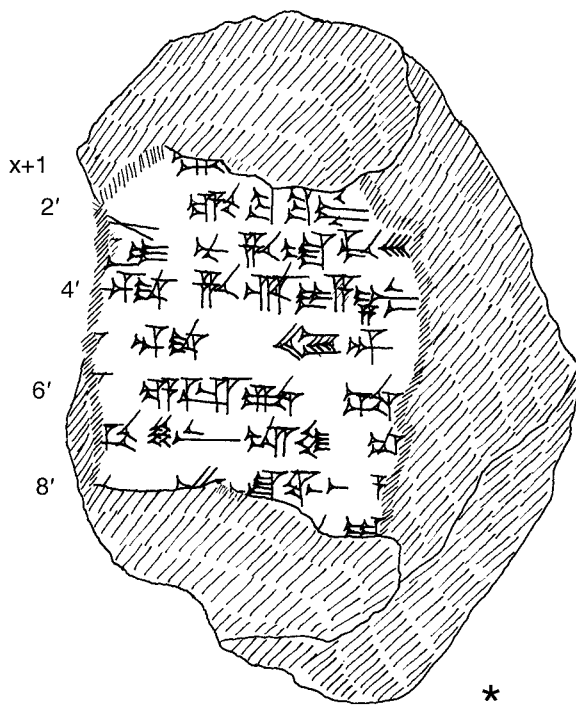

Text 47

AnAr 11501

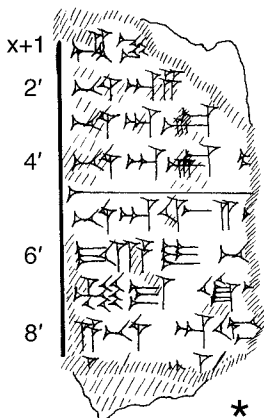

*

önyüz / obverse

Text 48

AnAr 11503 e

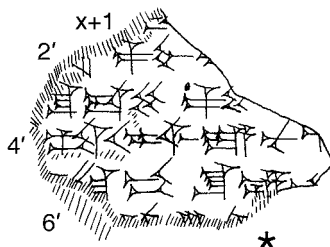

*

Text 51

AnAr 12171

Text 49

AnAr 11503 g

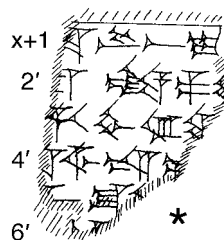

*

arkayüz / reverse

Text 50

AnAr 11620 b

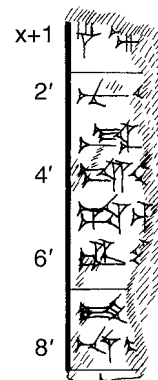

*

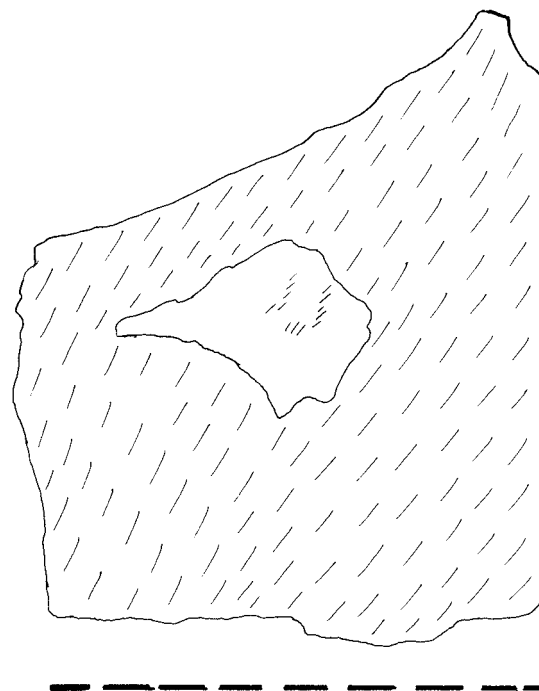
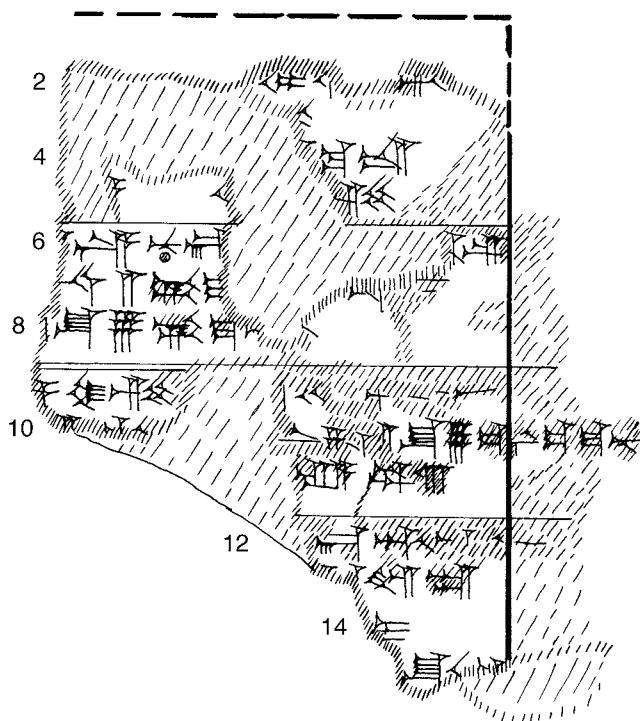

Text 52

AnAr 14916

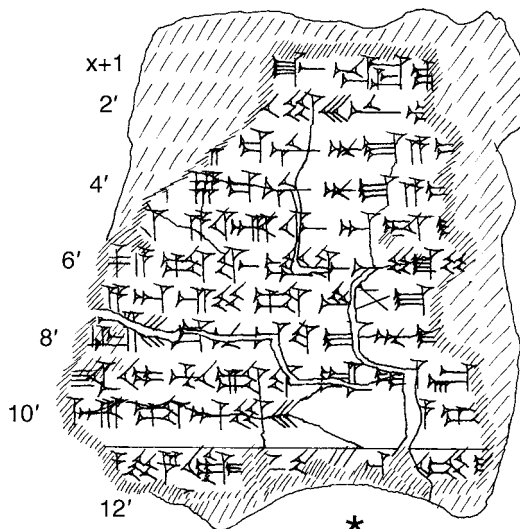

*

Text 53

AnAr 14989

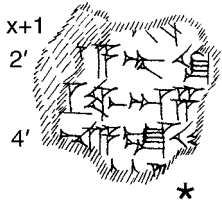

Text 54

AnAr 21813

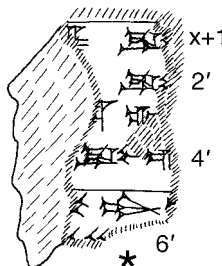

Text 55

AnAr 64-1-65

önyüz / obverse

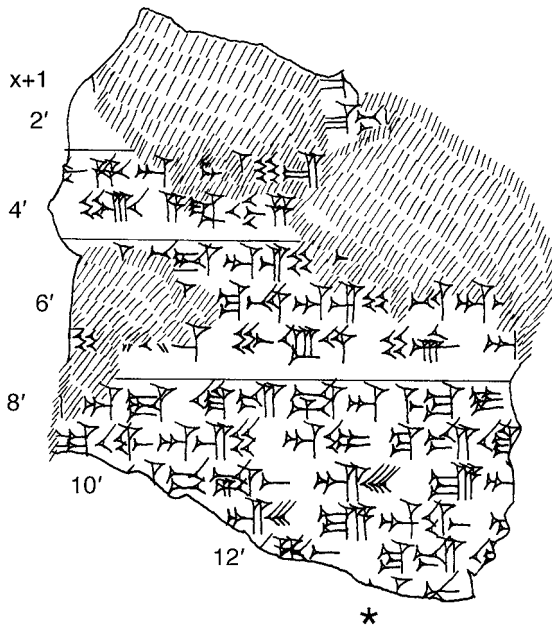

Text 56

AnAr 14973

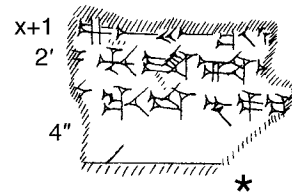

Text 57

AnAr 4220 r

önyüz / obverse

arkayüz / reverse

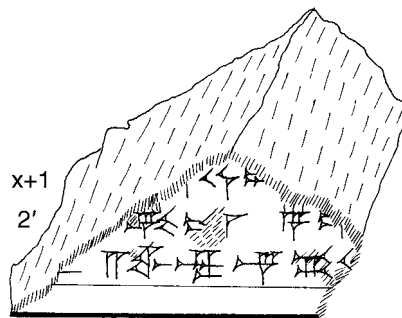
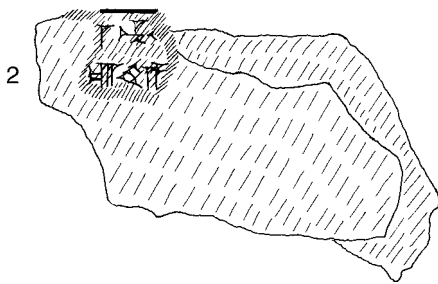

Text 58

AnAr 14951

önyüz? / obverse?

arkayüz? / reverse?

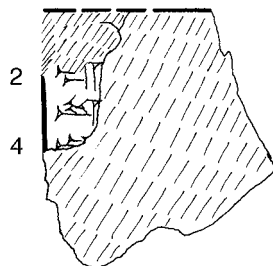
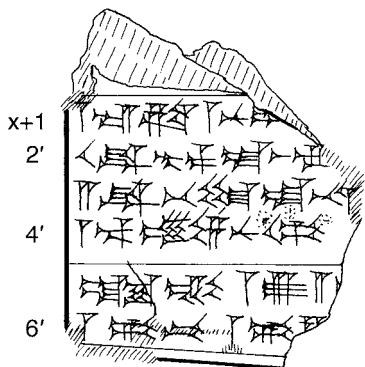

Text 59

AnAr 6992

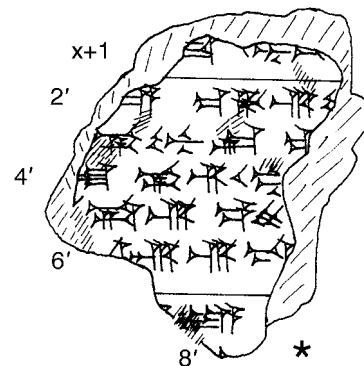

Text 60

AnAr 8360 1
arkayüz / reverse

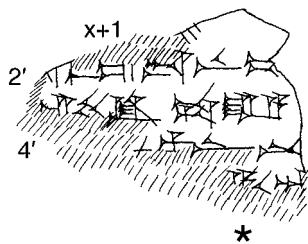

Text 61

AnAr 8365 f

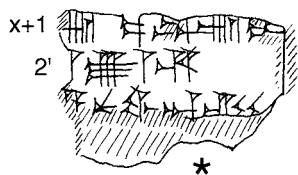

Text 62

AnAr 9138

önyüz / obverse

arkayüz / reverse

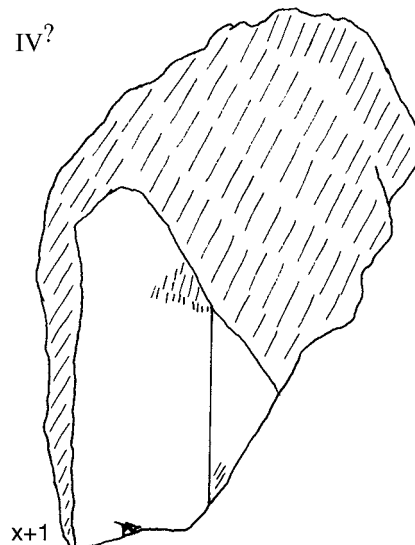
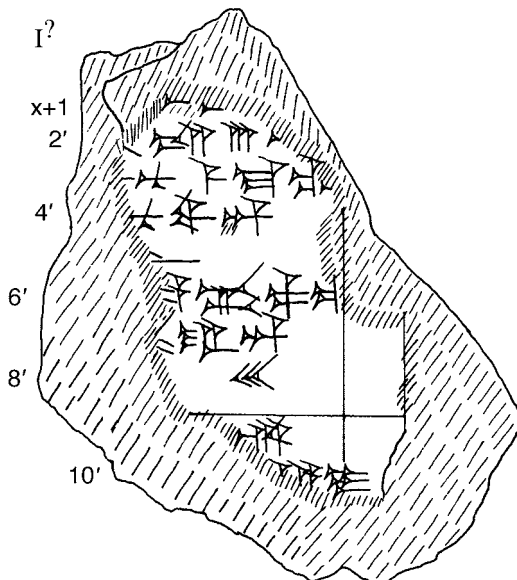

Text 63

AnAr 9166

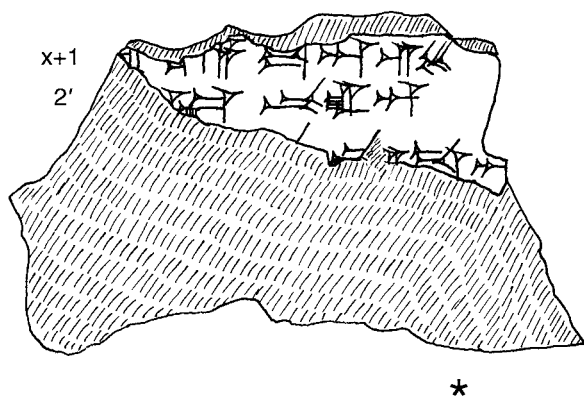

Text 64

AnAr 9465

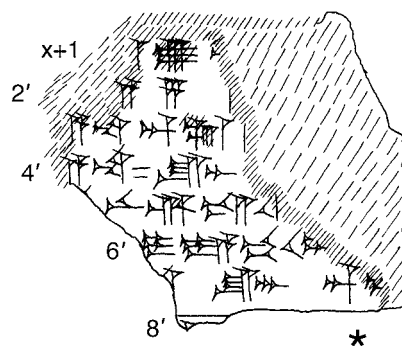

Text 65

AnAr 9715

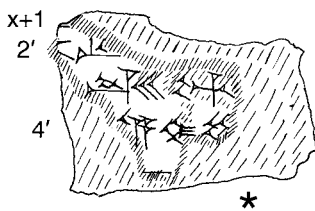

Text 66

AnAr 10322

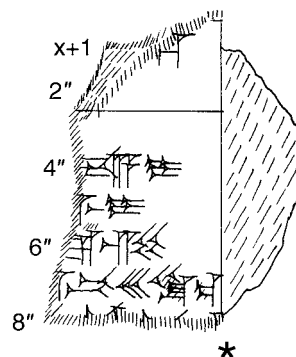

Text 67

AnAr 10592

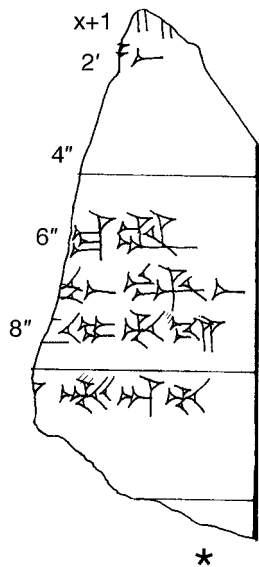

Text 68

AnAr 10598

önyüz? / obverse?

arkayüz? / reverse?

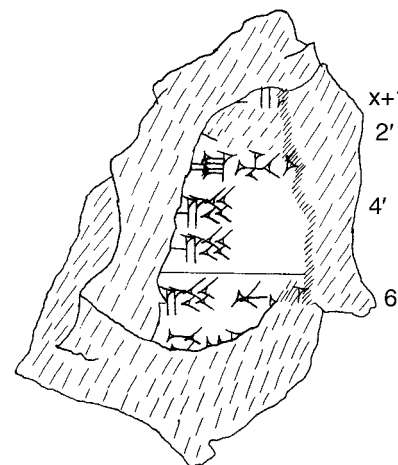
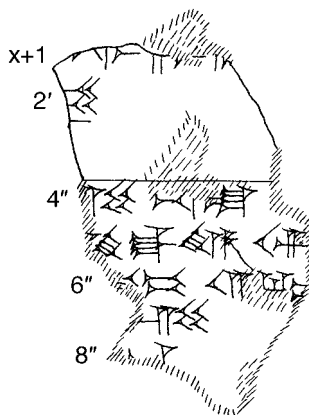

Text 69

AnAr 10603

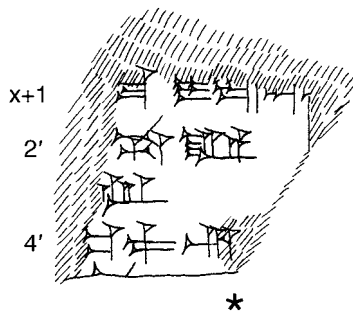

Text 70

AnAr 11246 d

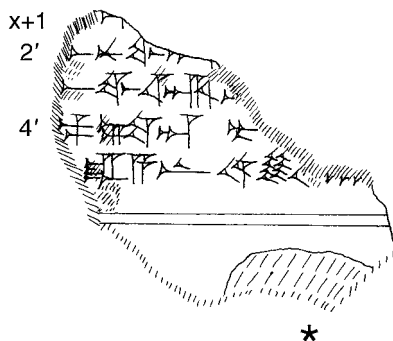

Text 71

AnAr 11246 e

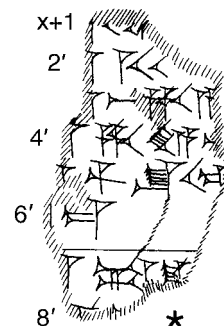

Text 72

AnAr 11391

önyüz? / obverse?

arkayüz? / reverse?

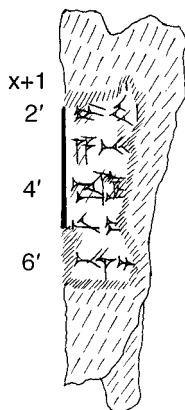
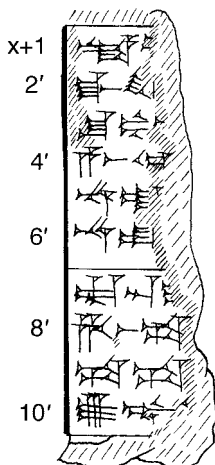

Text 73

AnAr 11396

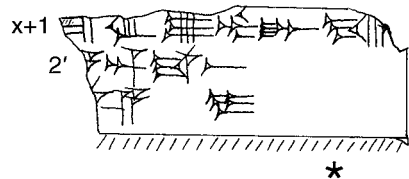

Text 74

AnAr 11614 a

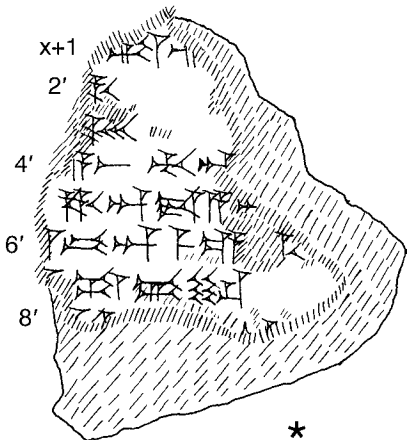

Text 75

AnAr 11616 b
arkayüz? / reverse?

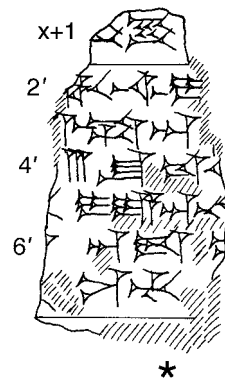

Text 76

AnAr 14453
önyüz / obverse

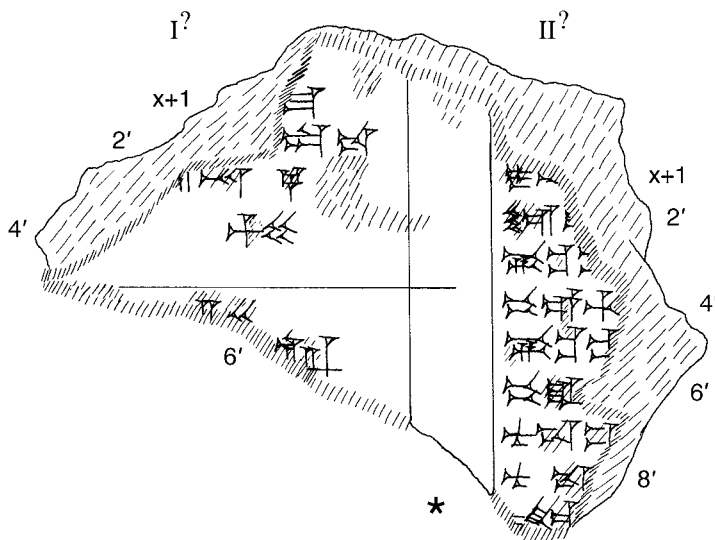

Text 77

AnAr 12131 f



Text 78

AnAr 12131 h

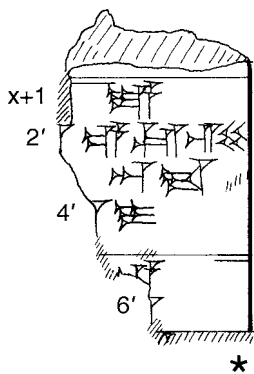

Text 79

AnAr 12131 k

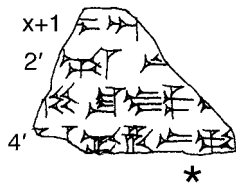

Text 80

AnAr 14931

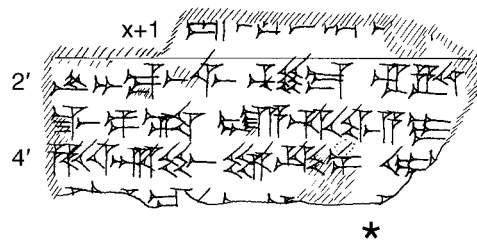

Text 81

AnAr 14933

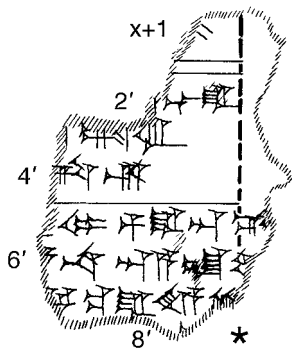

Text 82

AnAr 14958

önyüz? / obverse?

arkayüz? / reverse?

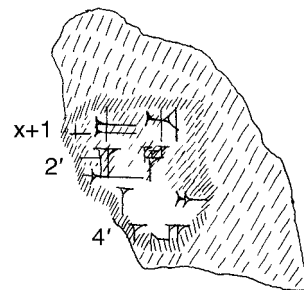
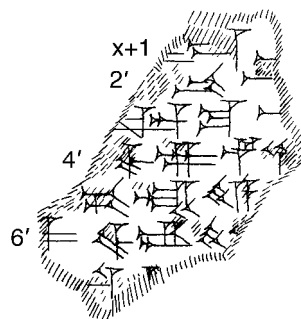

Text 83

AnAr 14965

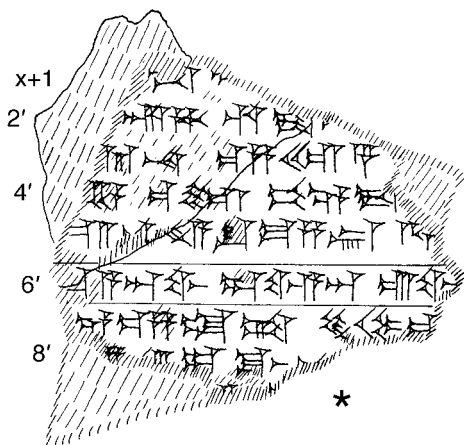

Text 84

AnAr 14994

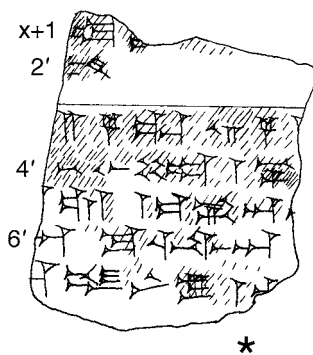

Text 85

AnAr 15155

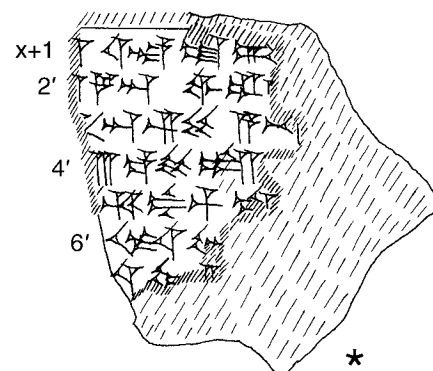

Text 86

AnAr 21631

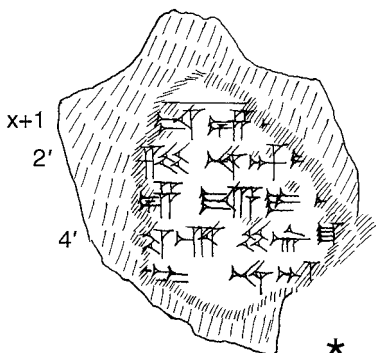

Text 87

AnAr 21370

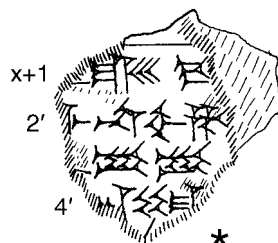

Text 88

AnAr 4220 e

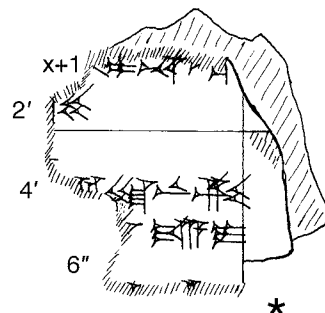

Text 89

AnAr 28-1-66

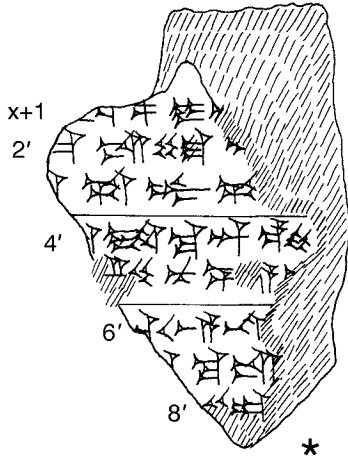

Text 90

AnAr 16-5-68

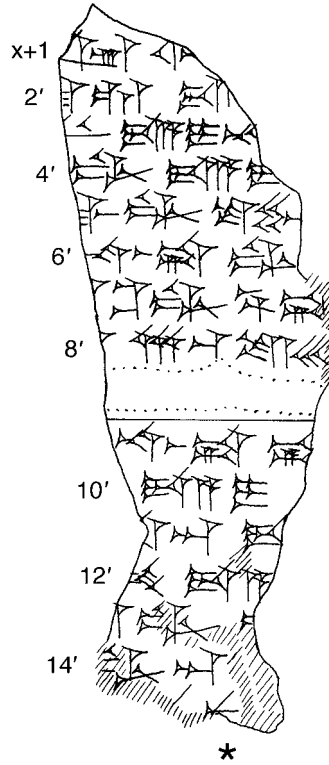

Text 91

AnAr 80-4-74

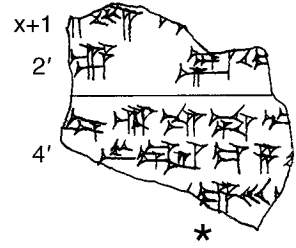

Text 92

AnAr 9464

önyüz / obverse

arkayüz / reverse

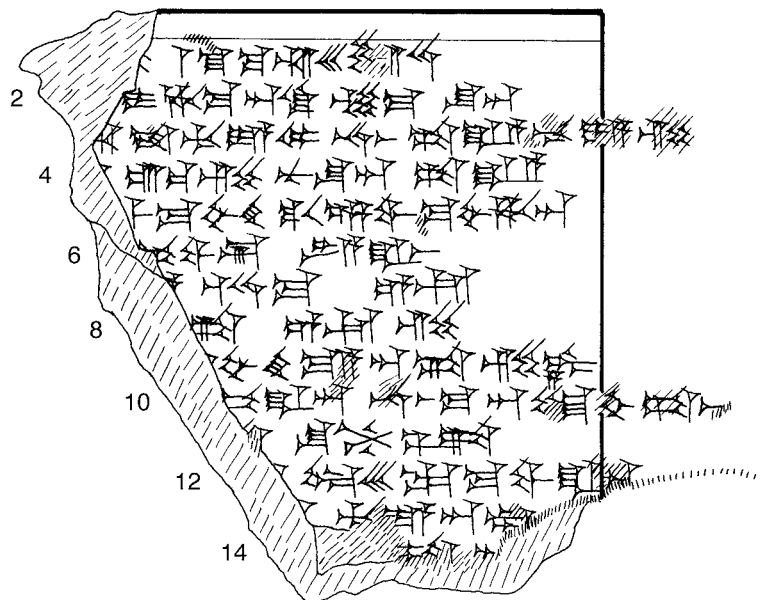
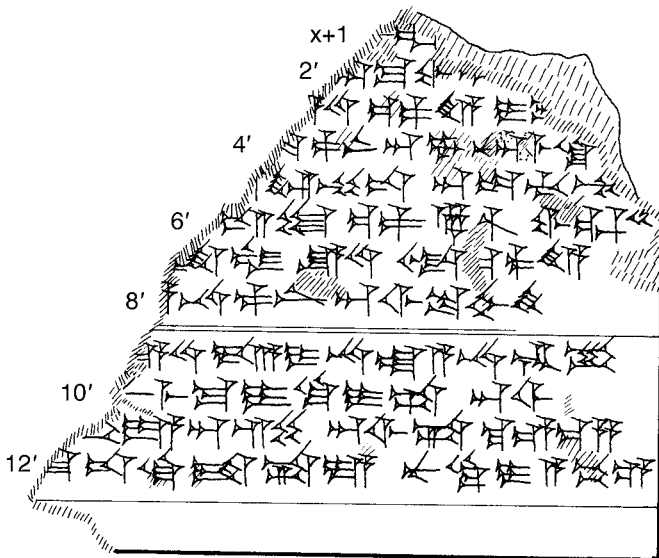

Text 93

AnAr 11618

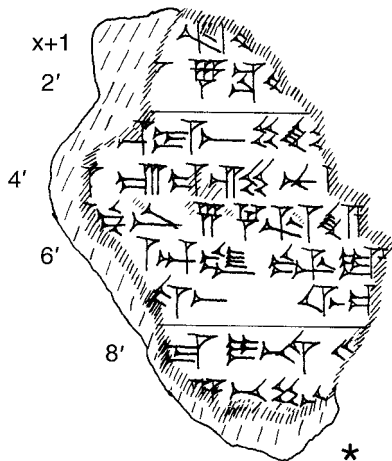

Text 94

AnAr 6984

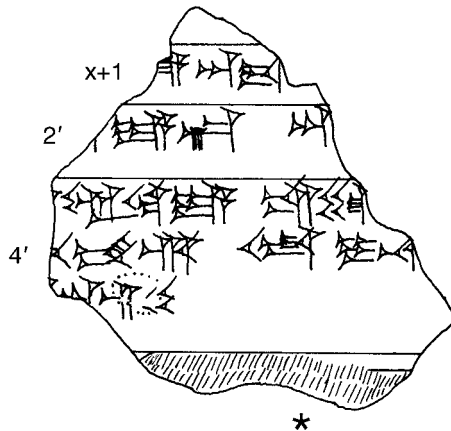

Text 95

AnAr 6987

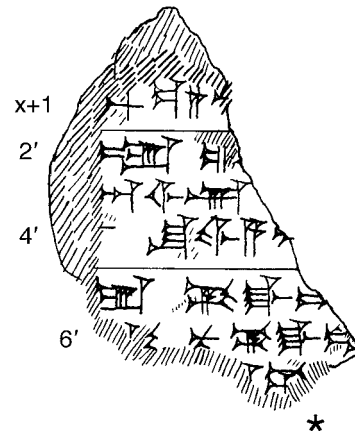

Text 96

AnAr 7007

önyüz / obverse

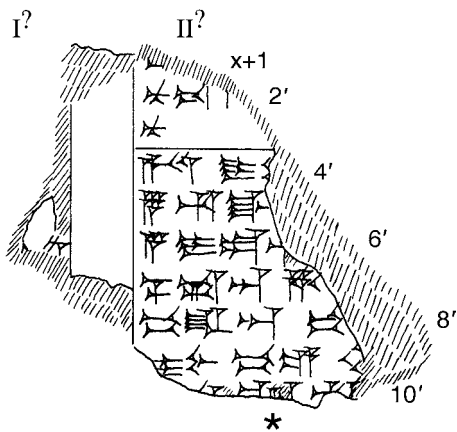

Text 98

AnAr 8360 a

önyüz / obverse

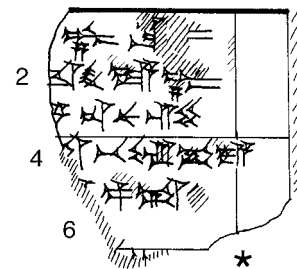

Text 99

AnAr 8363

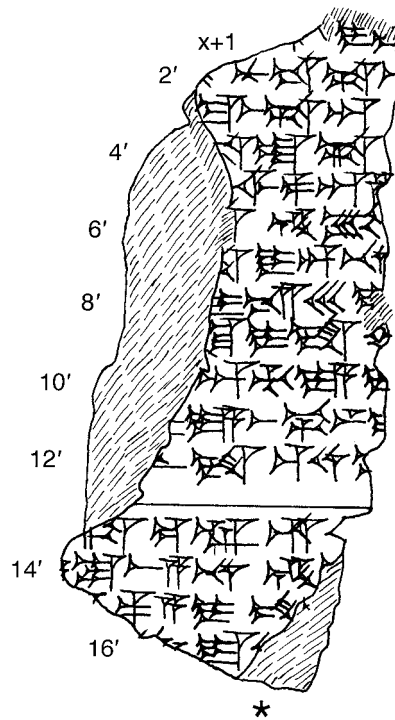

Text 97

AnAr 8358 a+b

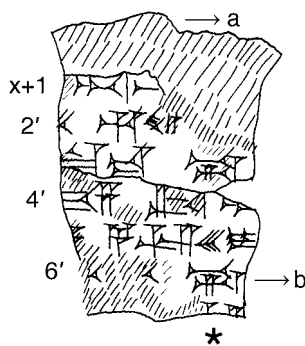

Text 100

AnAr 8847

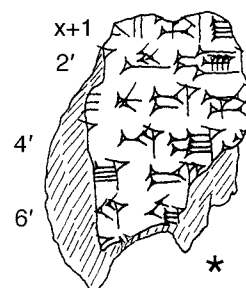

Text 101

AnAr 9157+KBo 41.114

önyüz? / obverse?

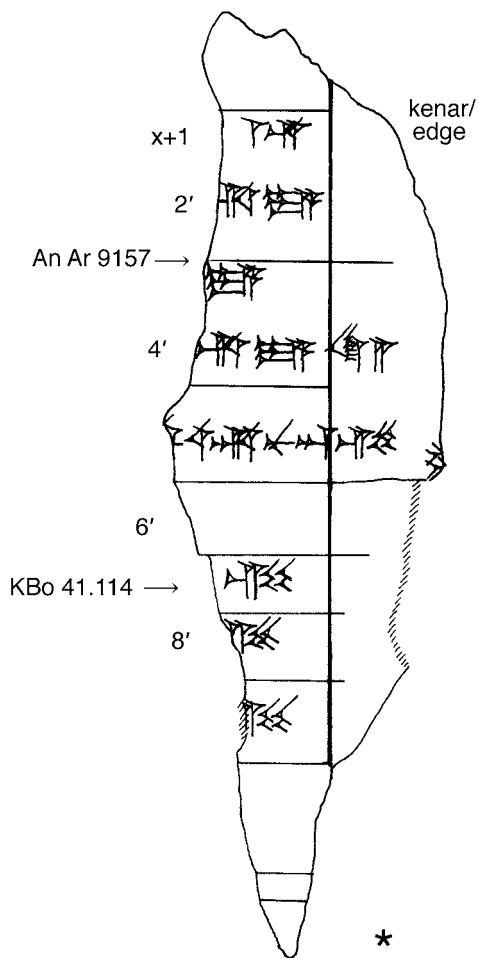

Text 102

AnAr 10310

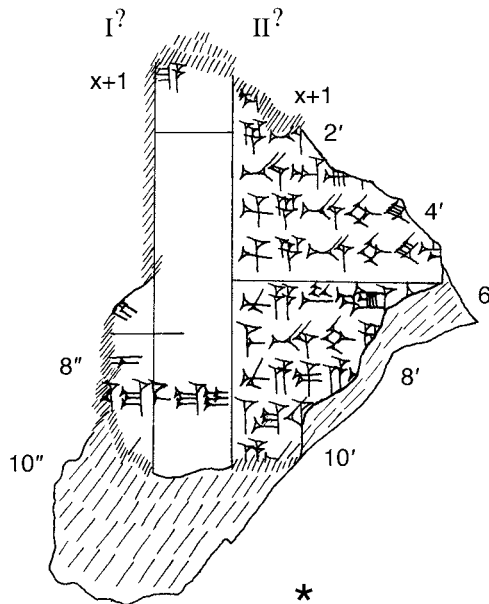

Text 103

AnAr 10313

önyüz / obverse

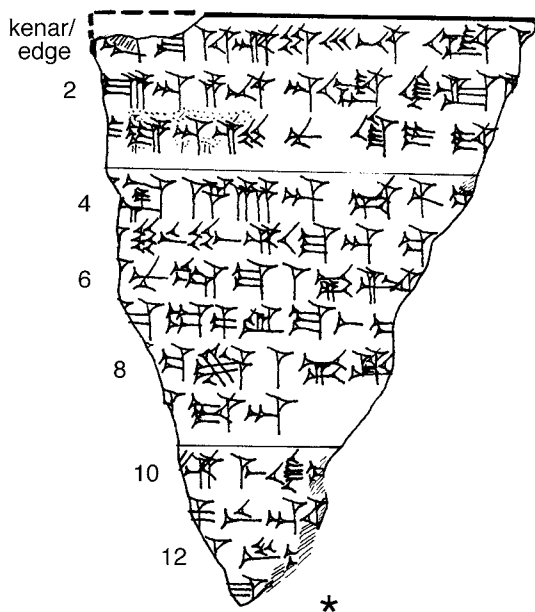

Text 104

AnAr 10587

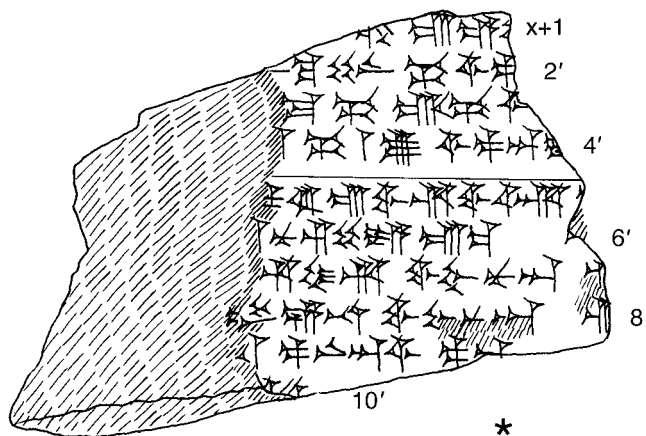

Text 105

AnAr 10865

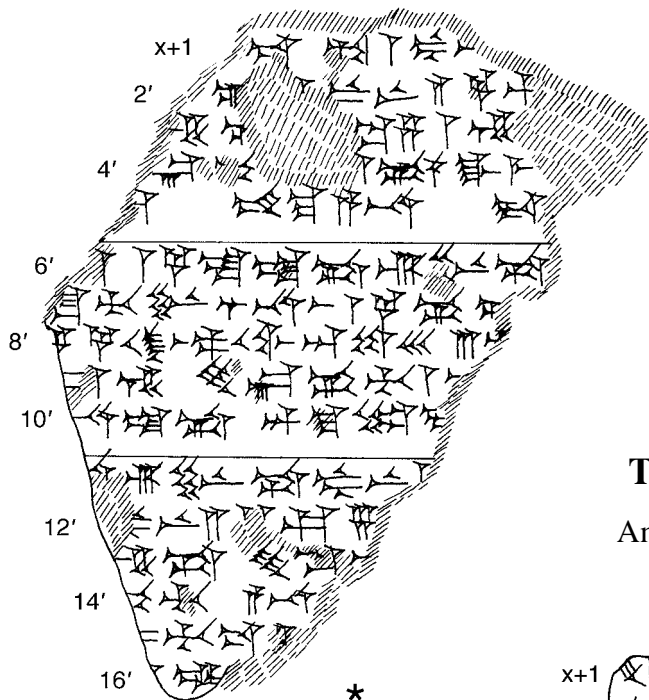

Text 106

AnAr 11246 g

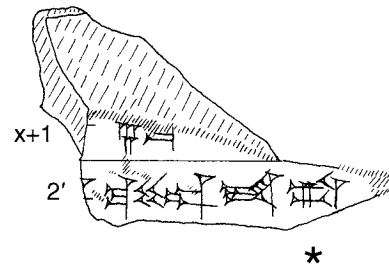

Text 107

AnAr 11388

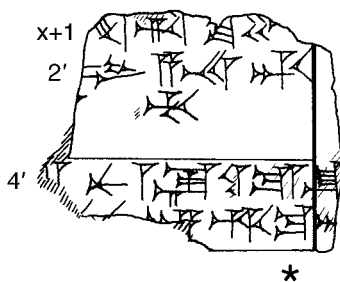

Text 108

AnAr 11408

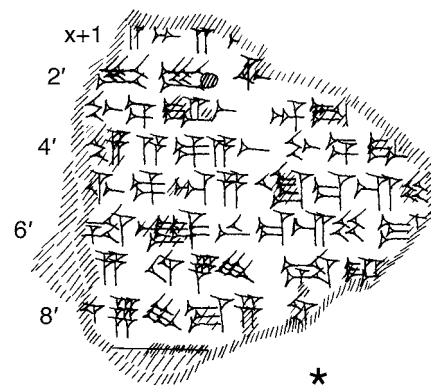

Text 109

AnAr 11620 a

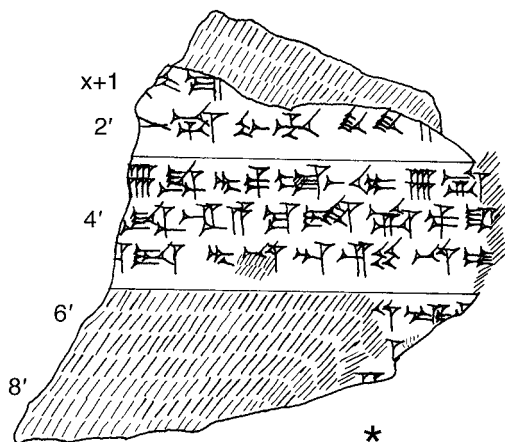

Text 110

AnAr 14919

önyüz / obverse

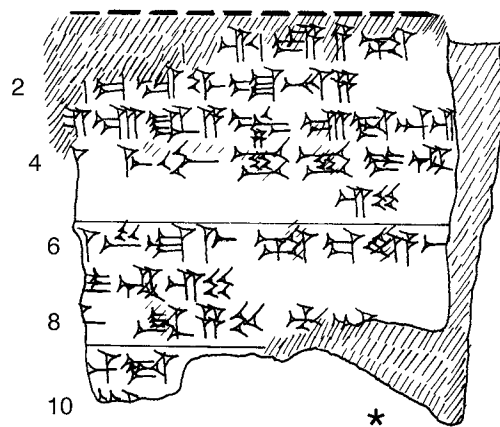

Text 111

AnAr 14955

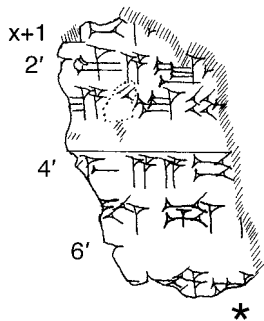

Text 112

AnAr 90-4-68

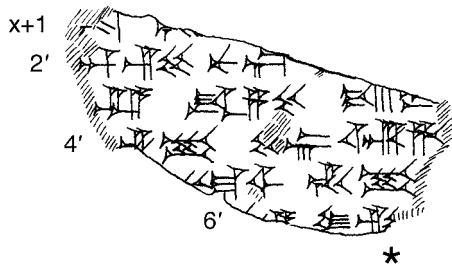

Text 113

AnAr 11615

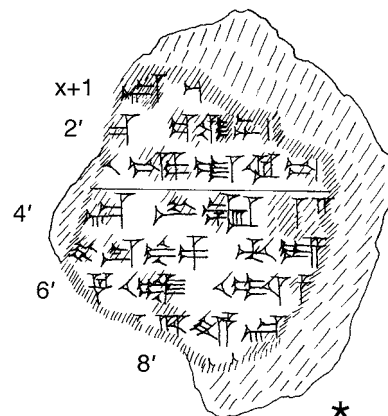

Text 114

AnAr 14922



Text 115

AnAr 6964+6991

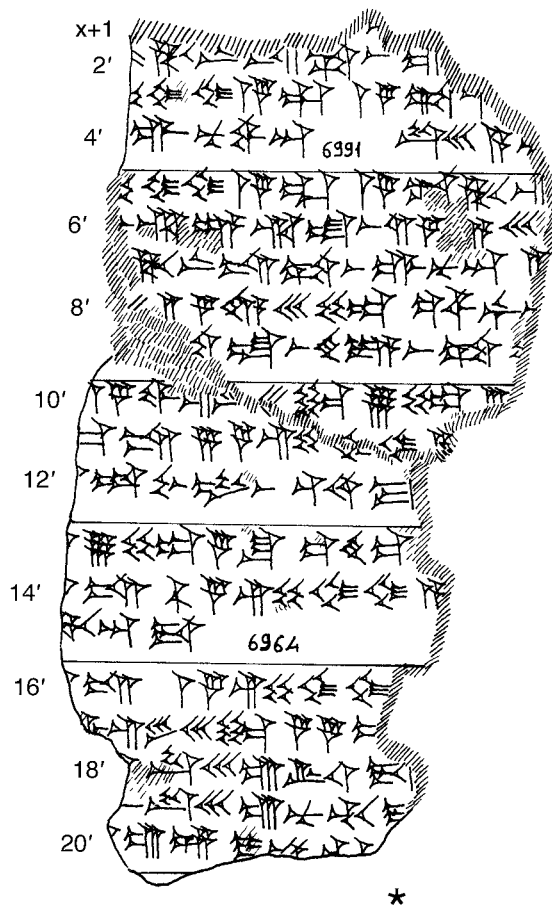

Text 116

AnAr 10326

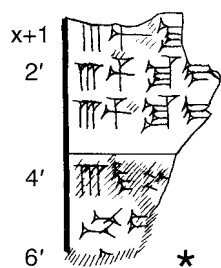

Text 117

AnAr 10606
önyüz / obverse

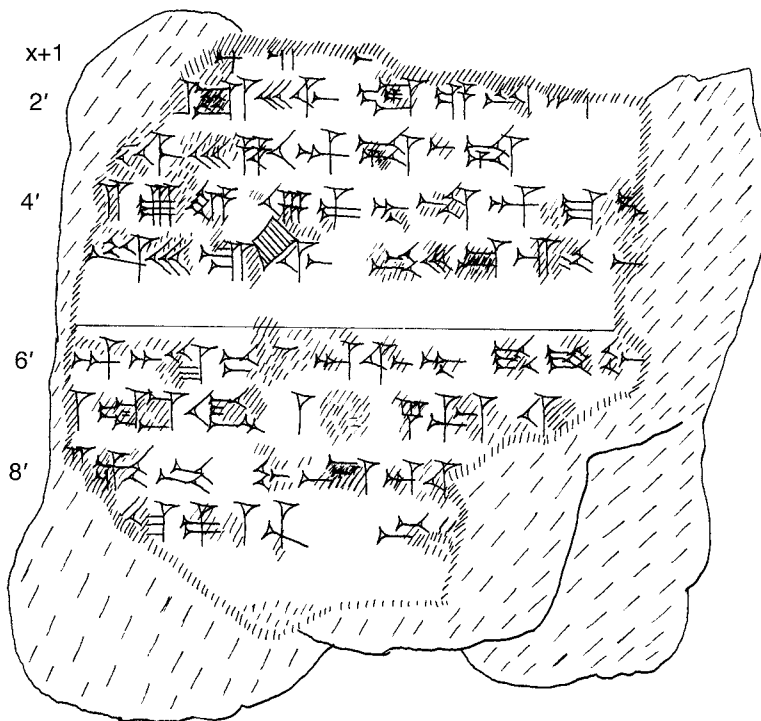

arkayüz / reverse



Text 118

AnAr 10871
önyüz / obverse



sol kenar / left edge

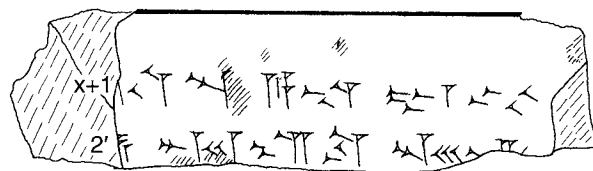

Text 119

AnAr 11499

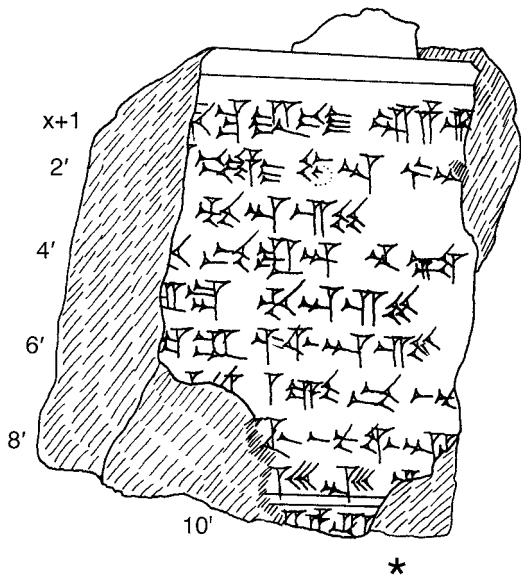

Text 120

AnAr 14913

önyüz / obverse

arkayüz / reverse



Text 121

AnAr 3544

önyüz / obverse

arkayüz / reverse

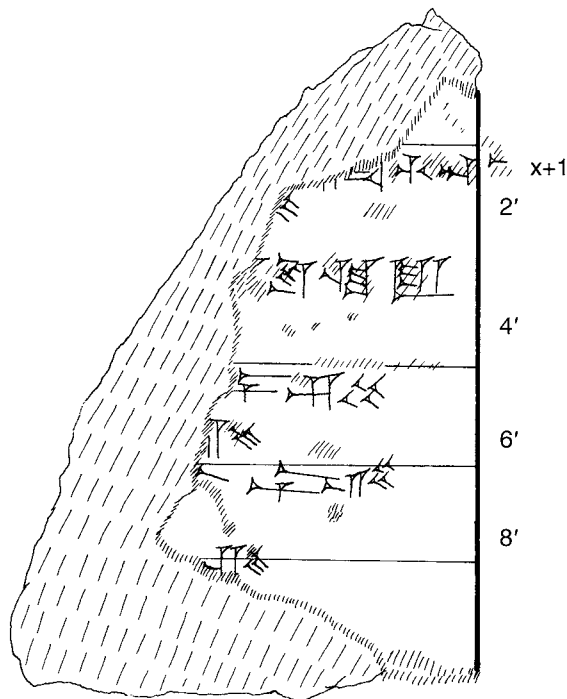
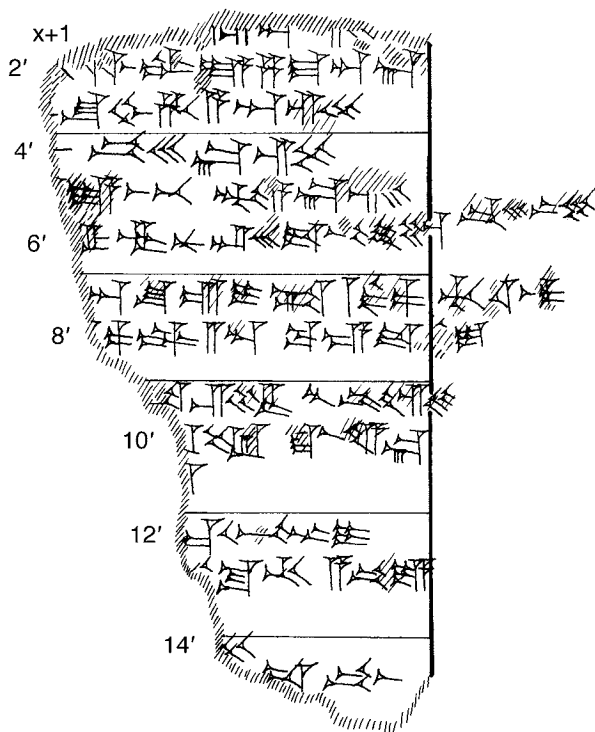

Text 122

AnAr 10315

önyüz / obverse

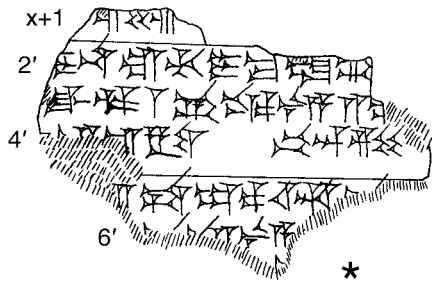

Text 123

AnAr 11613 c

önyüz / obverse



Text 124

AnAr 14920

önyüz / obverse

arkayüz / reverse

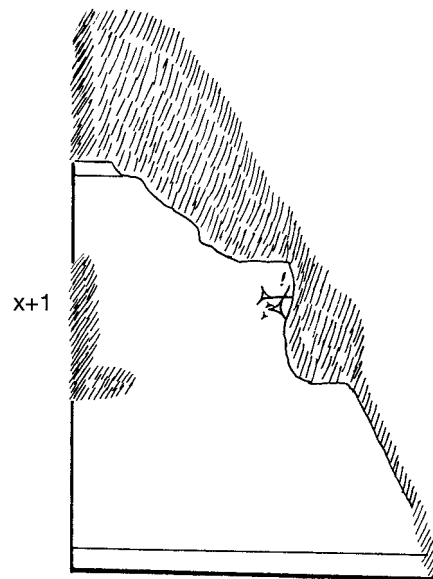
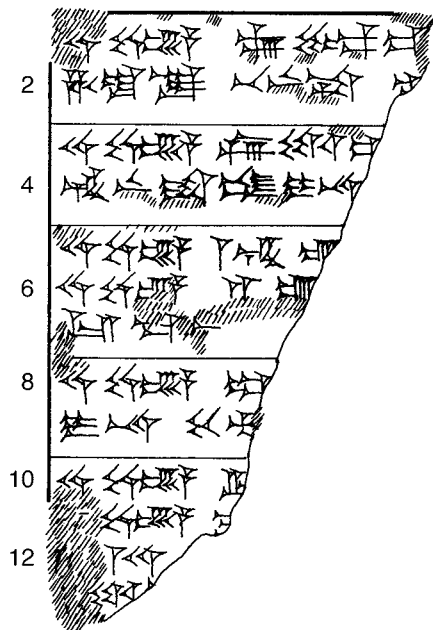

Text 125

AnAr 11407



Text 126

AnAr 8357 b+c+d+e+g+h

önyüz / obverse

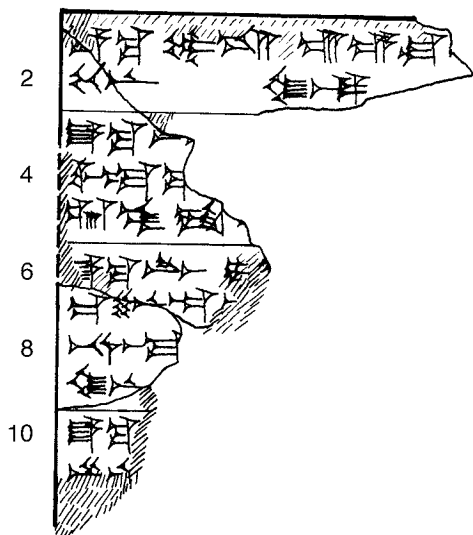

arkayüz / reverse

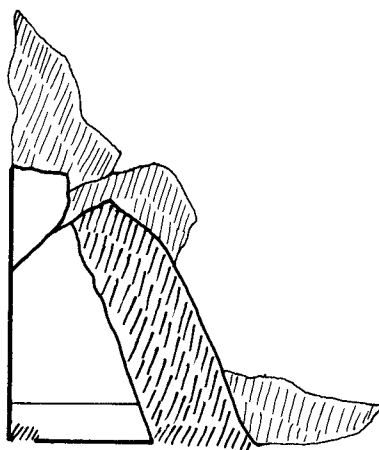

Text 127

AnAr 10609

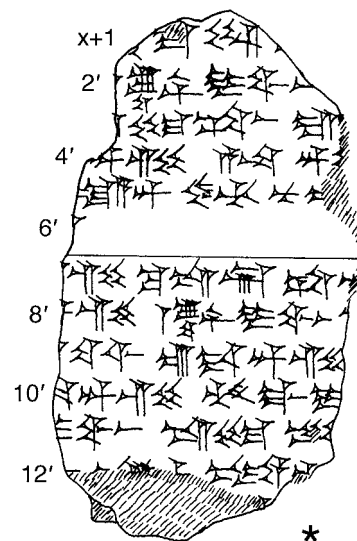

*

Text 129

AnAr 8357a

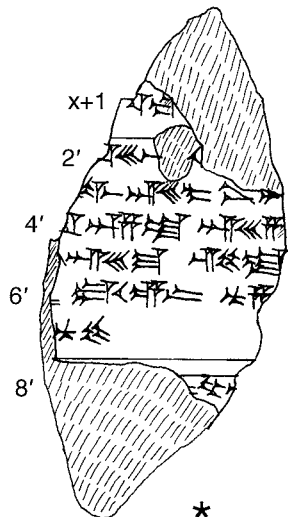

Text 130

AnAr 8840

önyüz / obverse

arkayüz / reverse

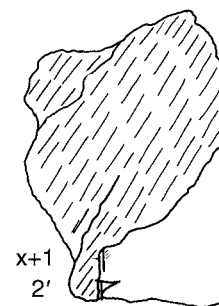
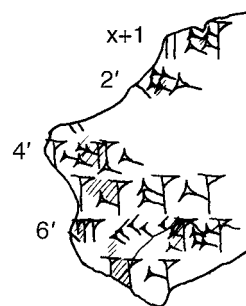

Text 128

AnAr 10872

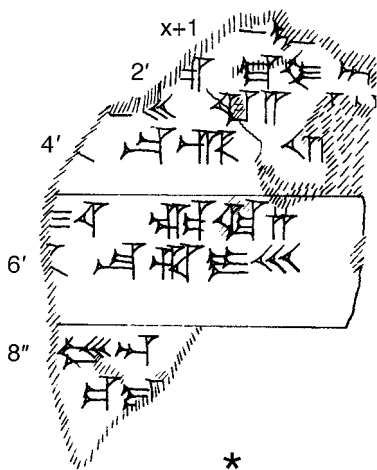

Text 131

AnAr 9163

arkayüz / reverse

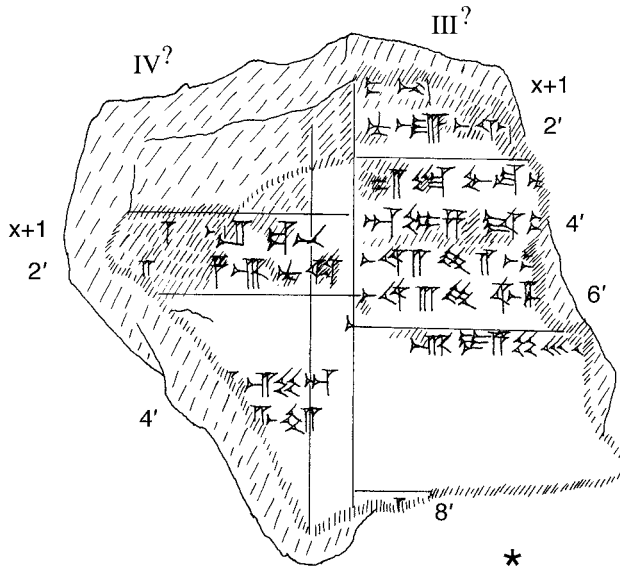

Text 132

AnAr 11246 1

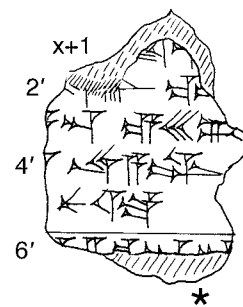

Text 133

AnAr 11387

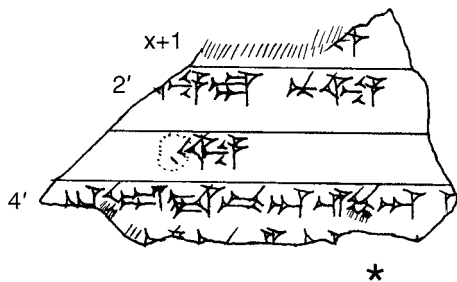

Text 134

AnAr 12174

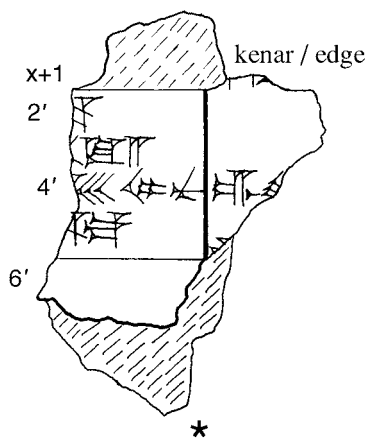

Text 135

AnAr 12216

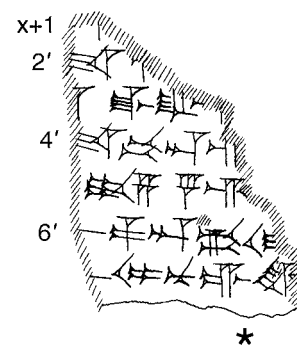

Text 136

AnAr 10757

arkayüz / reverse

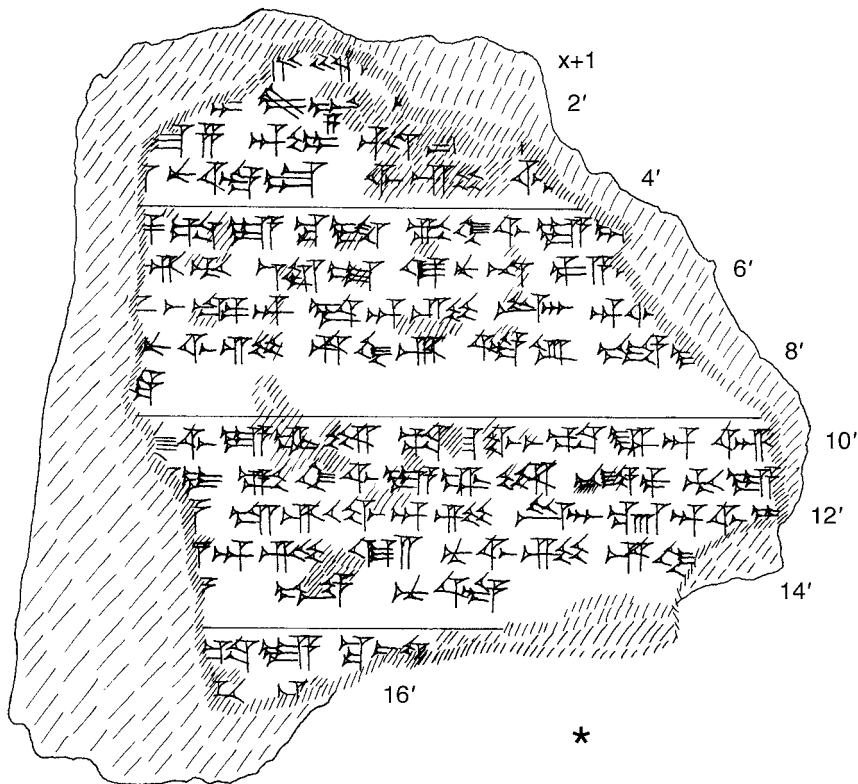

Text 138

AnAr 90-6-68

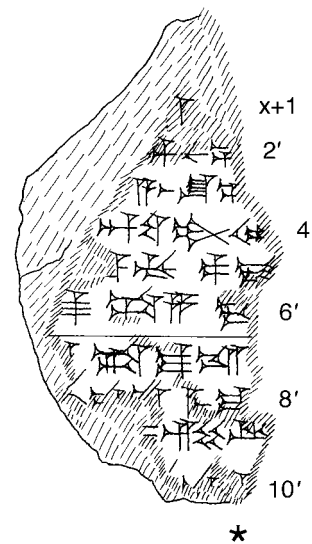

Text 137

AnAr 15151+KUB 5.17

önyüz / obverse

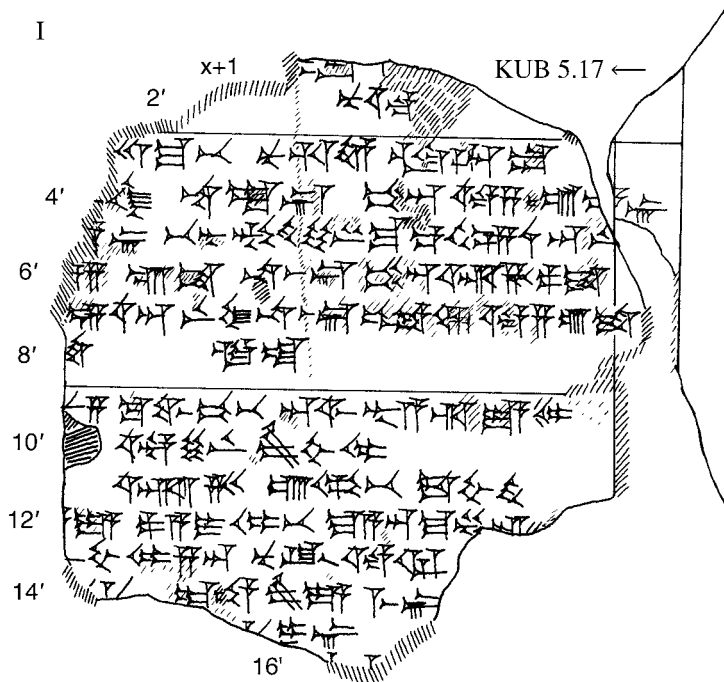

Text 139

AnAr 70-1-76

önyüz / obverse

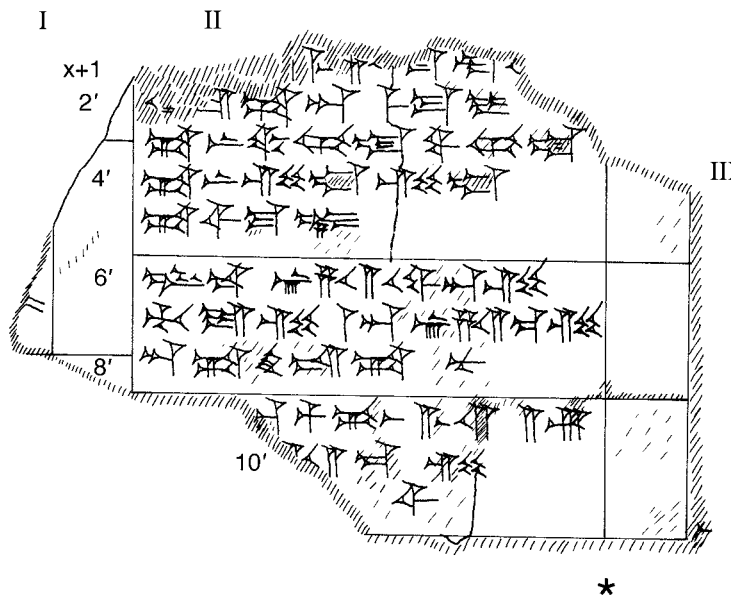

Text 140

AnAr 10285

önyüz / obverse



arkayüz / reverse



Text 141

AnAr 12157

önyüz / obverse

arkayüz / reverse

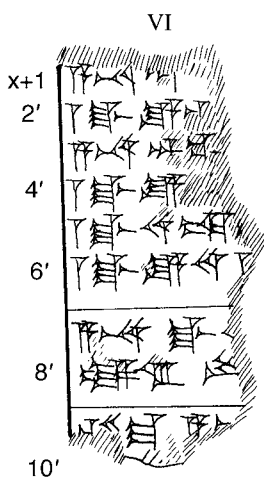
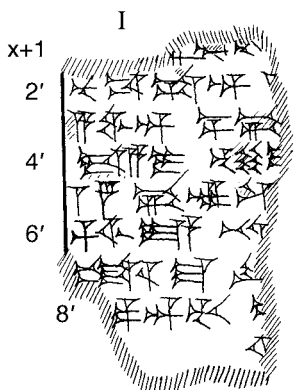

Text 142

AnAr 8360 i

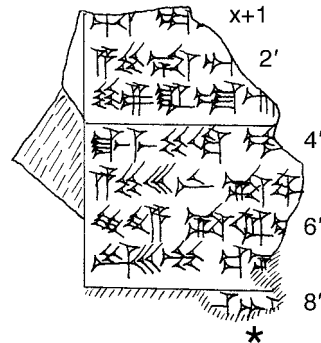

Text 143

AnAr 96-2-76

Text 145

AnAr 9723

önyüz / obverse

Text 144

AnAr 16-6-68

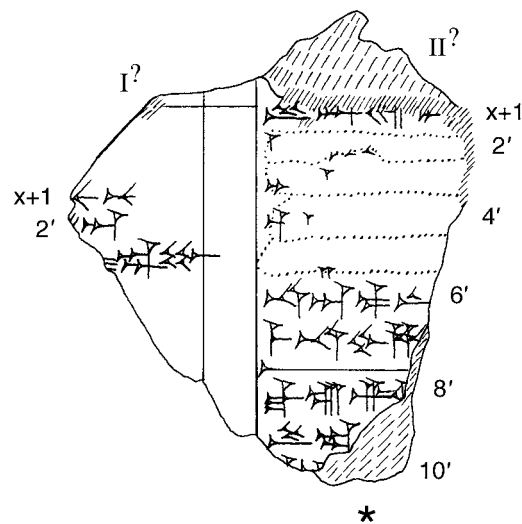
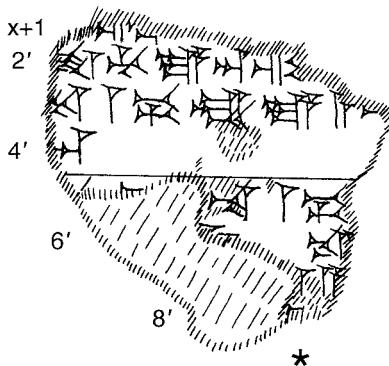
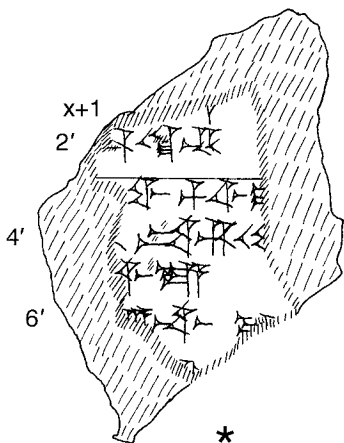

Text 146

AnAr 12156

Text 147

AnAr 11502 c

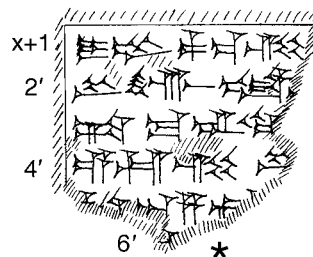

Text 148

AnAr 10311
arkayüz / reverse



Text 149

AnAr 10300

önyüz / obverse

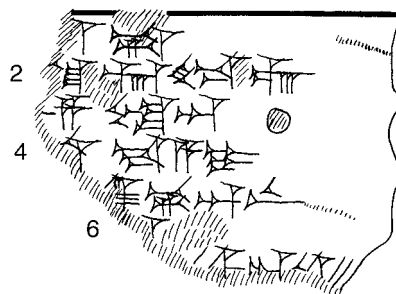

arkayüz / reverse

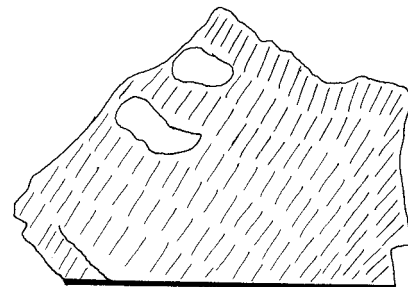

Text 152

AnAr 70-2-76
önyüz / obverse

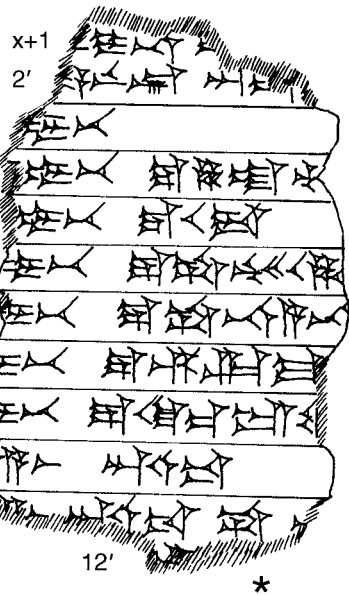

Text 150

AnAr 12176



Text 151

AnAr 4220 d

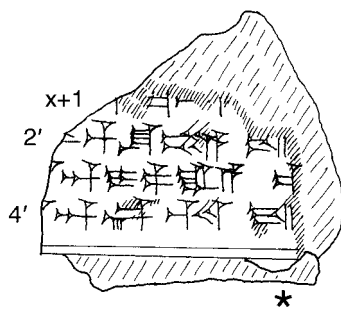

Text 154

AnAr 3137

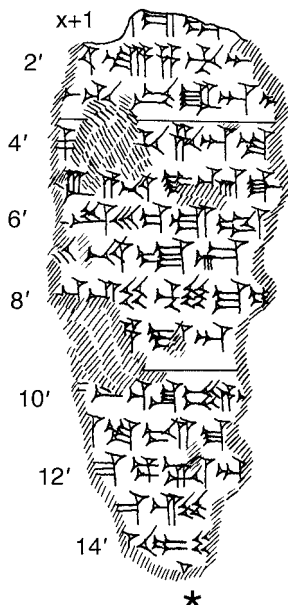

Text 153

AnAr 10299

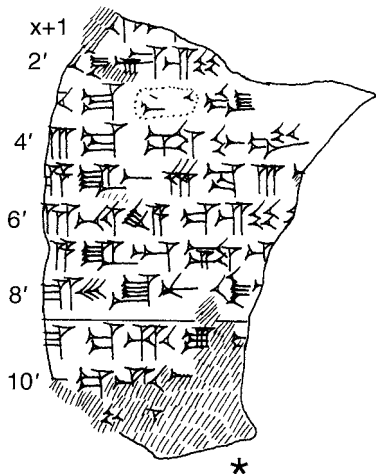

Text 155

AnAr 6995

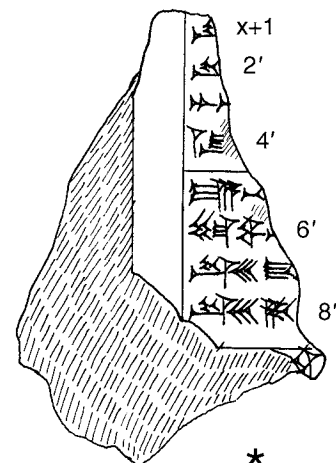

Text 156

AnAr 8357 f

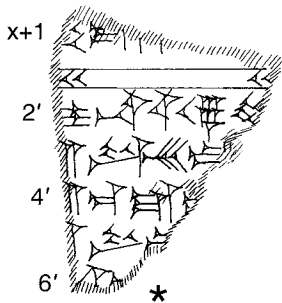

Text 157

AnAr 8360 c+g+m

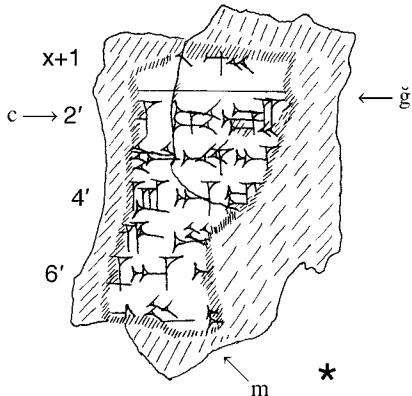

Text 158

AnAr 8360 f



Text 159

AnAr 8360 h

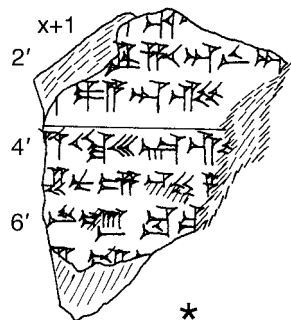

Text 160

AnAr 8360 n+s+ş

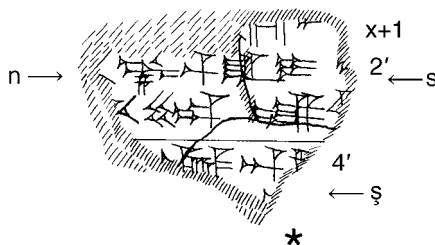

Text 161

AnAr 8365 b

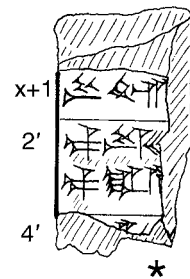

Text 162

AnAr 8857

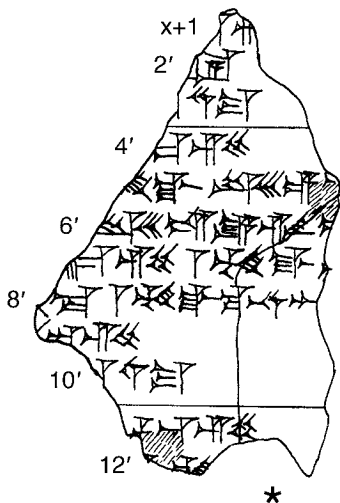

Text 163

AnAr 8911

önyüz / obverse

arkayüz / reverse

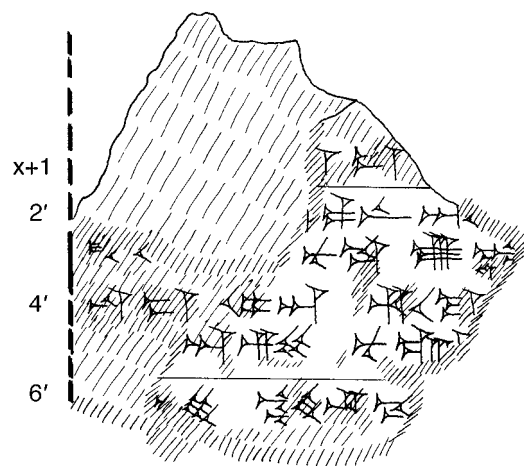
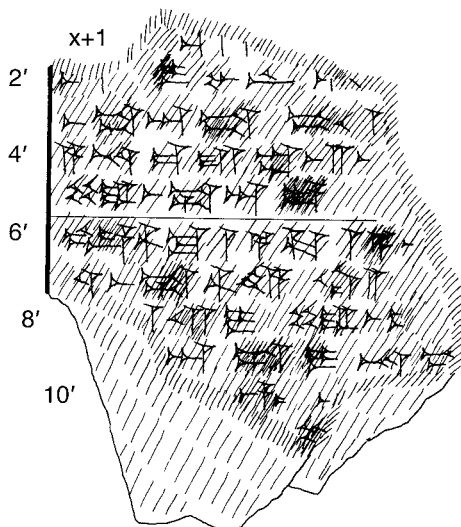

Text 164

AnAr 8919

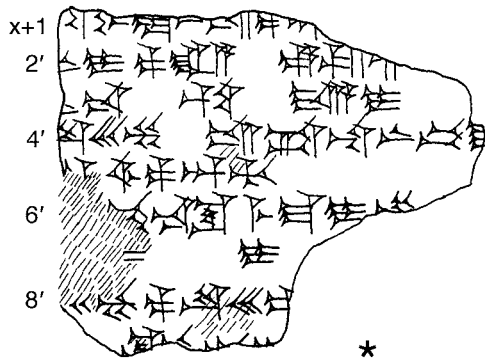

Text 165

AnAr 9145

önyüz? / obverse?

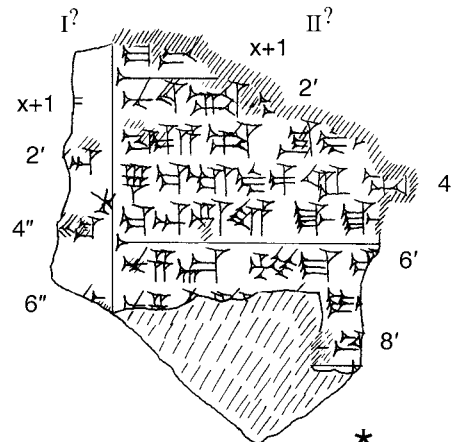

Text 166

AnAr 9716

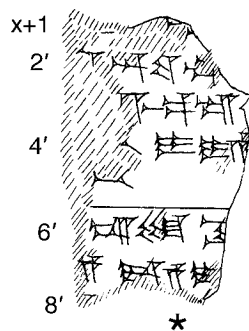

Text 167

AnAr 9720

önyüz / obverse

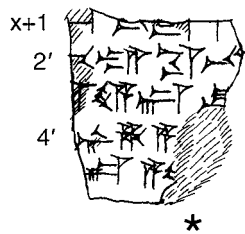

Text 168

AnAr 9730

önyüz / obverse

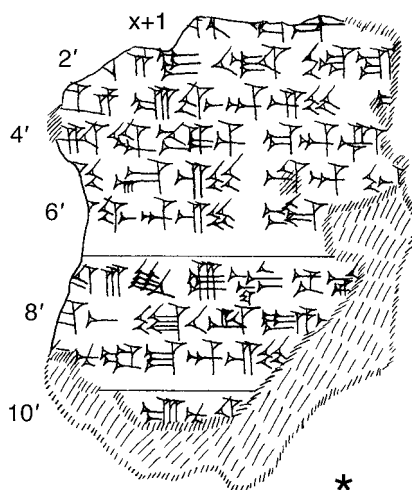

Text 169

AnAr 10301

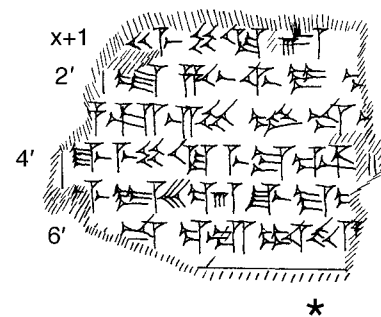

Text 170

AnAr 10309

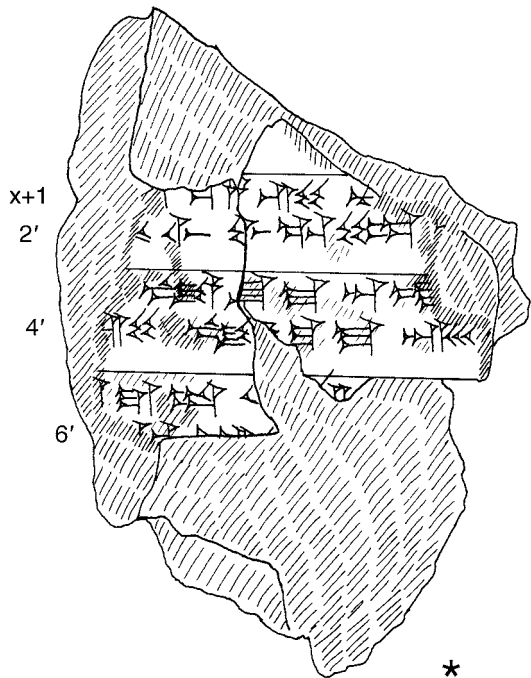

Text 171

AnAr 10325

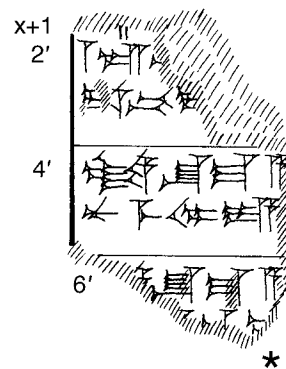

Text 172

AnAr 10588

önyüz / obverse

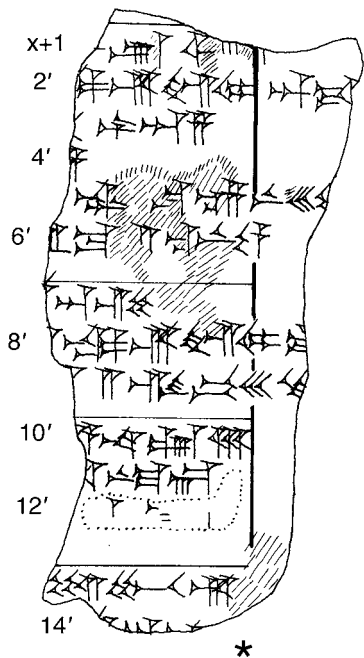

Text 173

AnAr 10593

önyüz / obverse

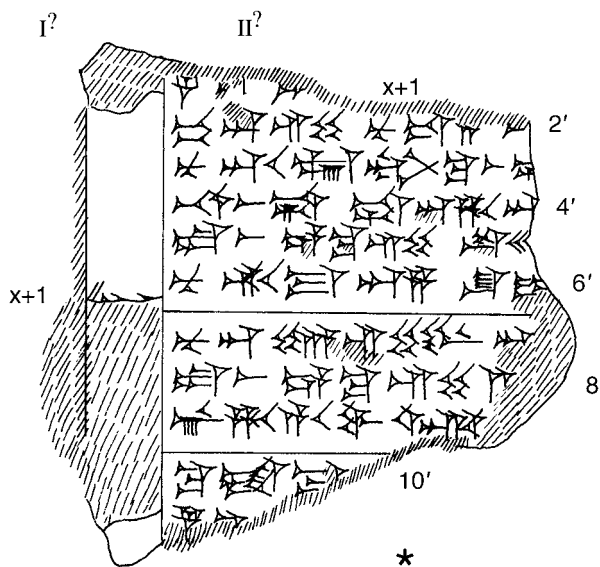

Text 174

AnAr 10596

önyüz / obverse

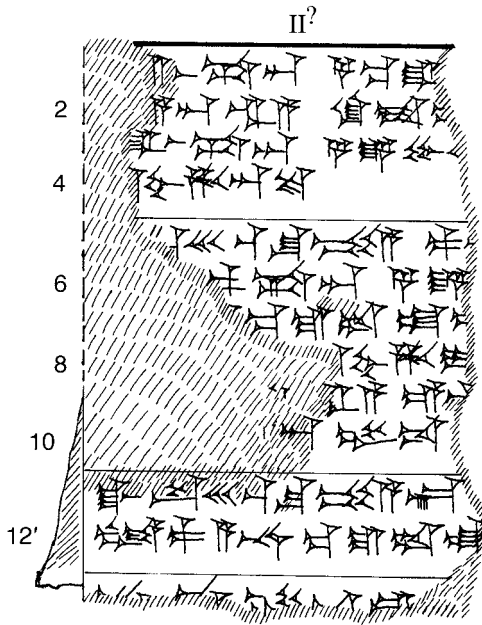

arkayüz / reverse

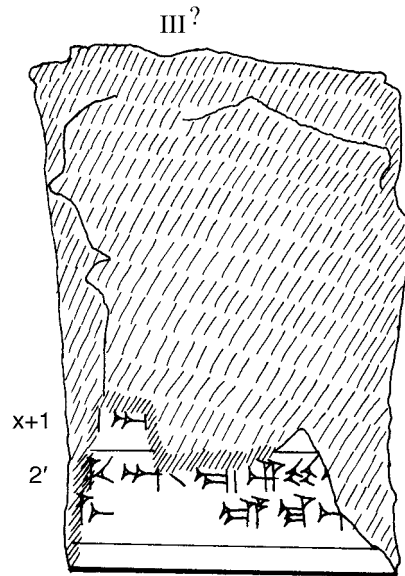

Text 175

AnAr 10597

önyüz / obverse

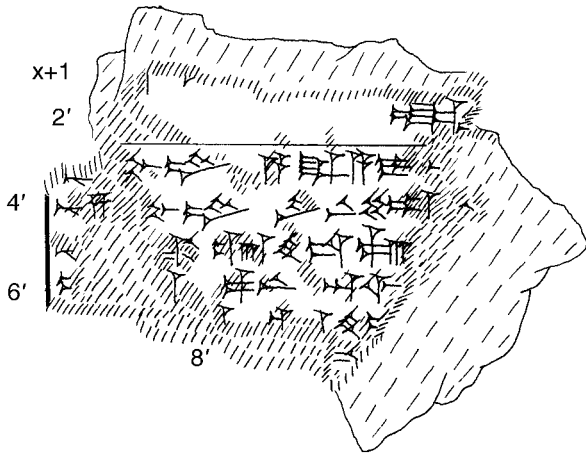

arkayüz / reverse

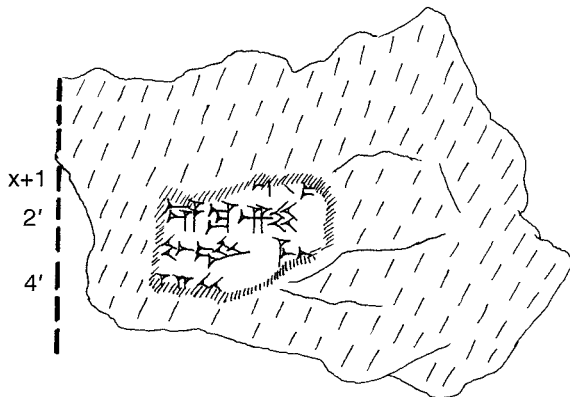

Text 176

AnAr 10604

önyüz / obverse

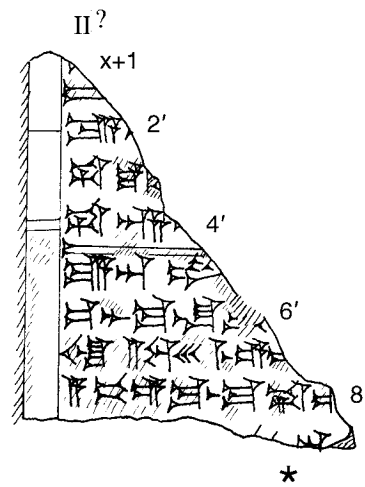

Text 177

AnAr 10611

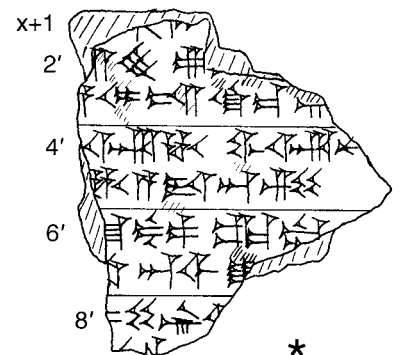

Text 178
AnAr 10758

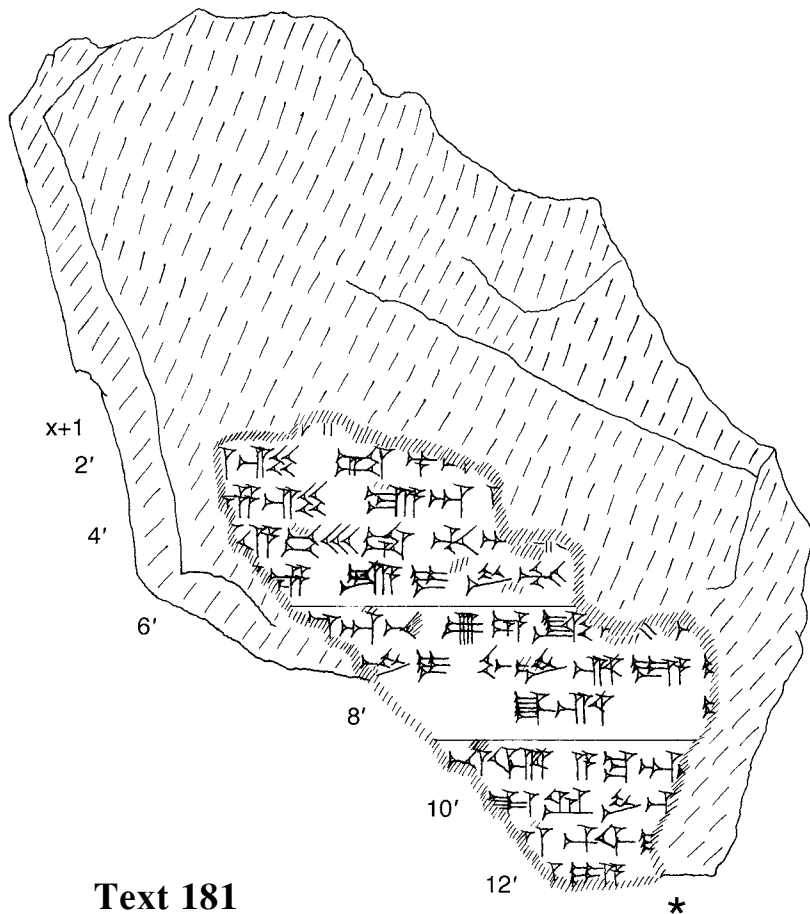

Text 181
11288 a
önyüz / obverse

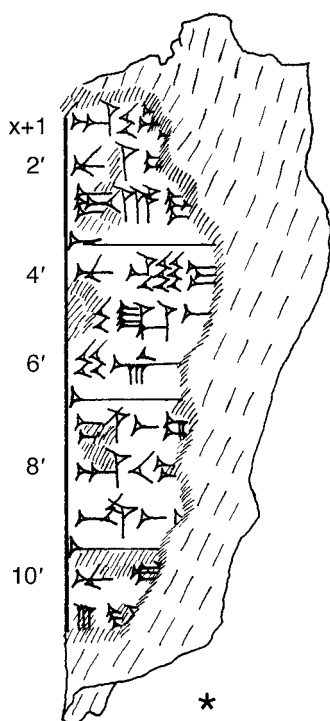

Text 179
AnAr 10866

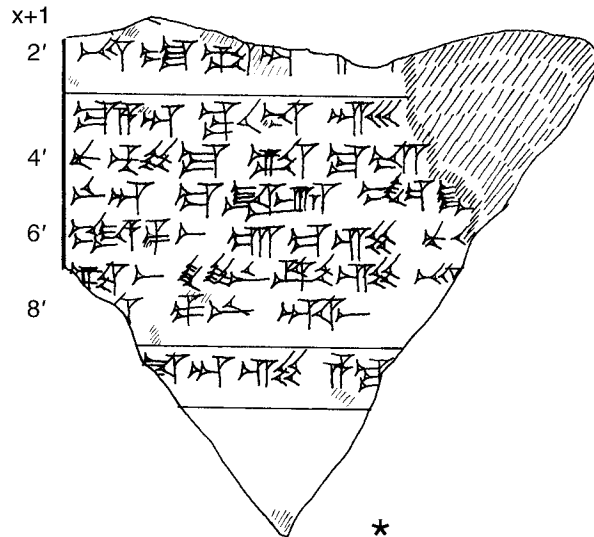

Text 180
AnAr 11246 h

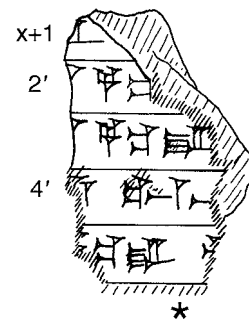

Text 182
AnAr 11288 b

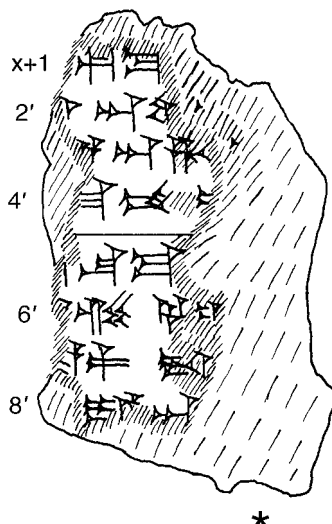

Text 183
AnAr 11385 b
önyüz / obverse

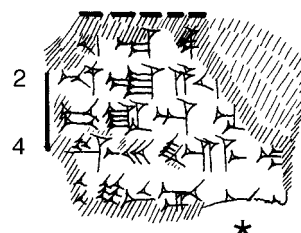

Text 184

AnAr 11402 a

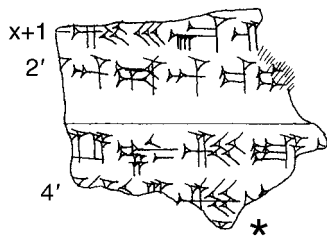

Text 185

AnAr 11503 b

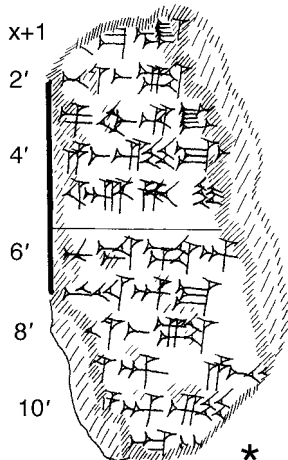

Text 186

AnAr 11504

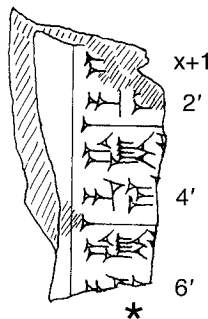

Text 187

AnAr 11619 a

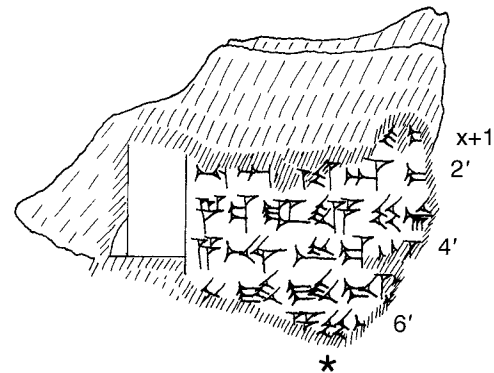

Text 188

AnAr 11621 b

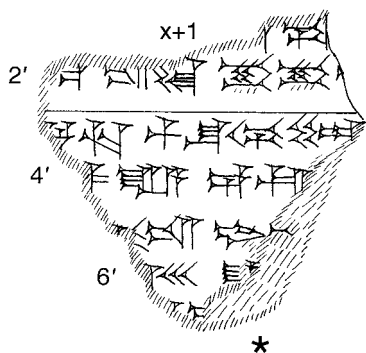

Text 189

AnAr 12166

arkayüz / reverse

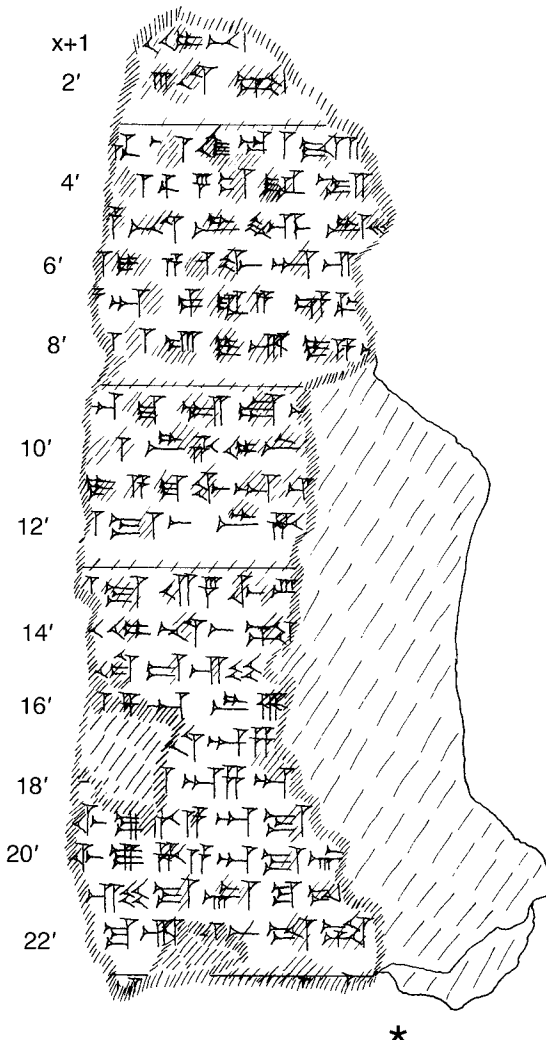

Text 190

AnAr 12169

önyüz / obverse

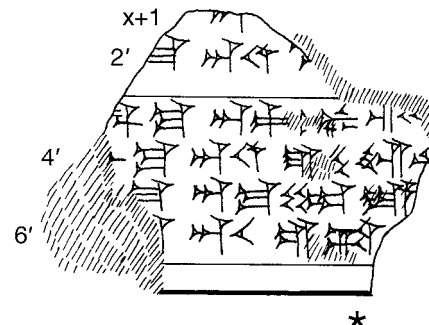

Text 191

AnAr 12178

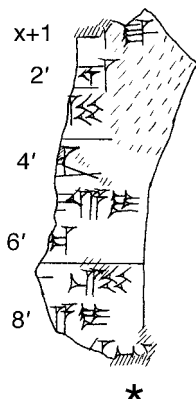

Text 192

AnAr 12186

önyüz? /
obverse?

sol kenar / left edge

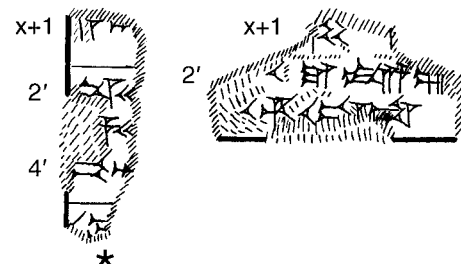

Text 193

AnAr 12188

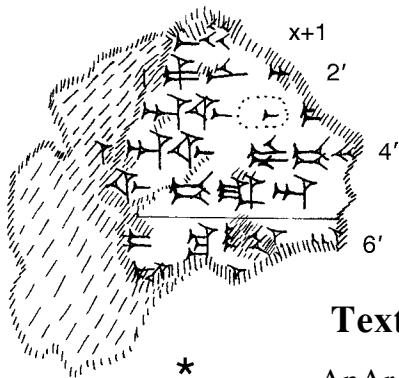

Text 194

AnAr 14839 b

önyüz / obverse

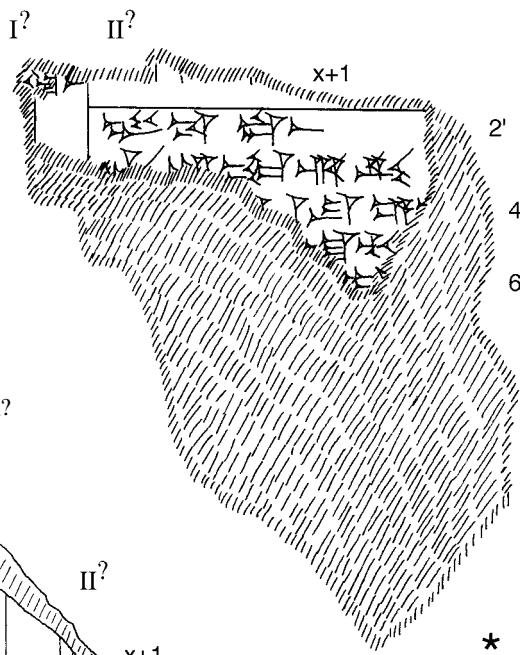

Text 195

AnAr 14839 c

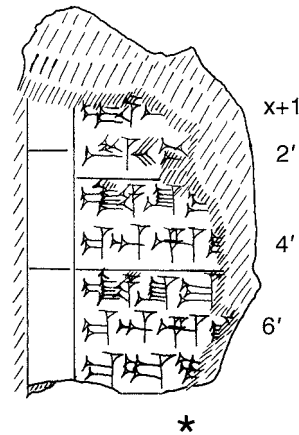

Text 196

AnAr 14923

önyüz? / obverse?

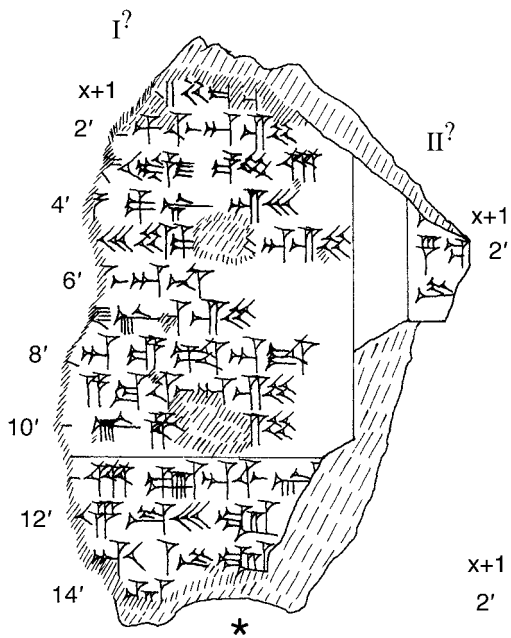

Text 198

AnAr 14927

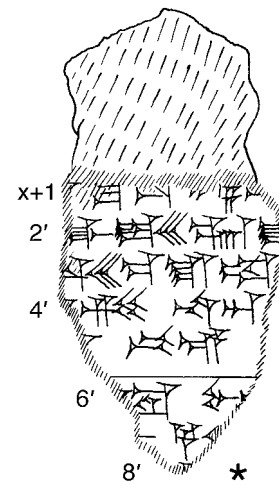

Text 197

AnAr 14926

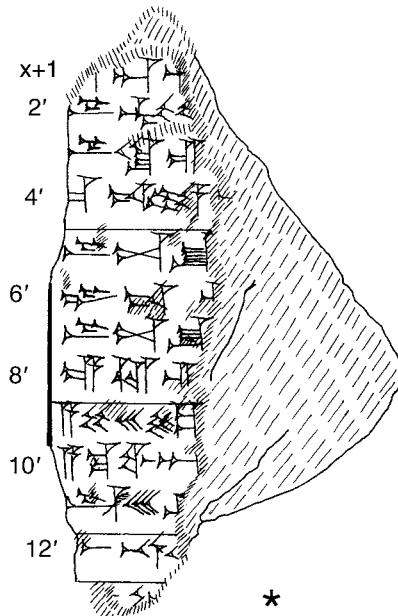

Text 199

AnAr 14928

önyüz / obverse

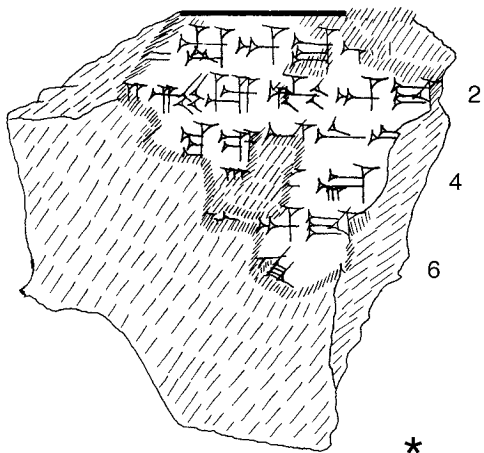

Text 200

AnAr 14936

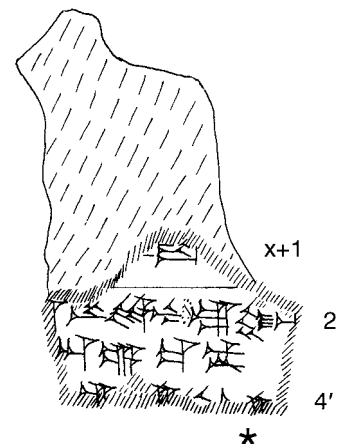

Text 201

AnAr 14939
önyüz / obverse

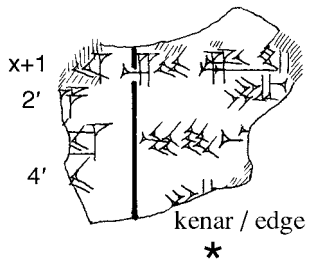

Text 202

AnAr 14942

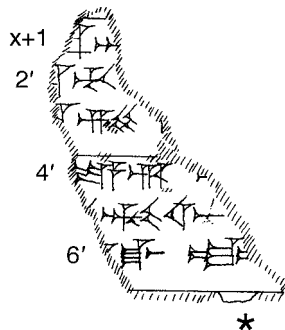

Text 203

AnAr 14967

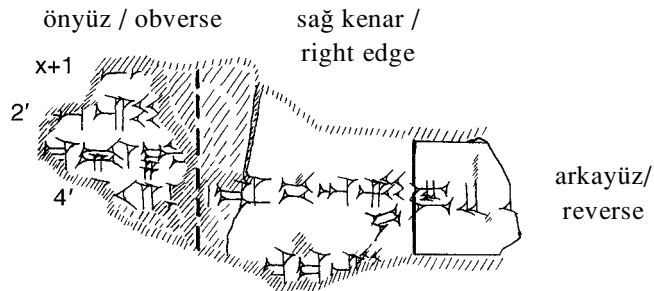

Text 204

AnAr 14970

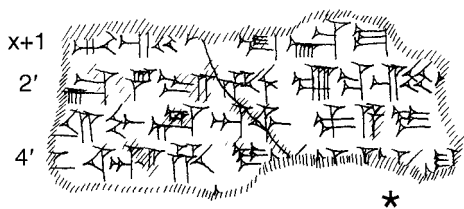

Text 205

AnAr 14971

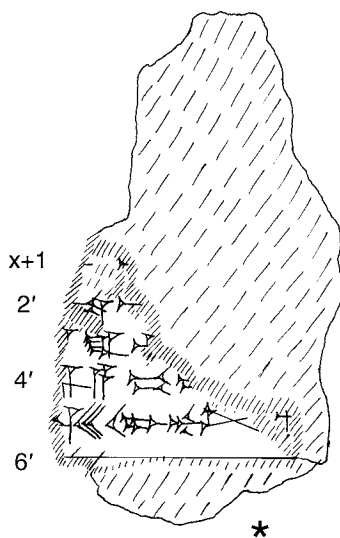

Text 206

AnAr 14972

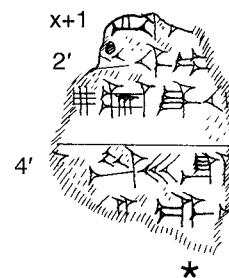

Text 207

AnAr 14984

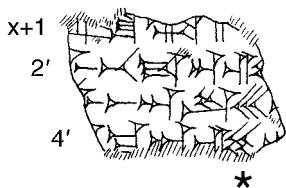

Text 208

AnAr 15160

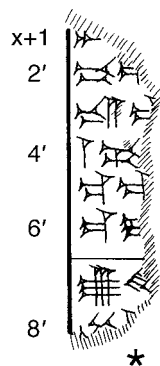

Text 209

AnAr 21627
arkayüz / reverse

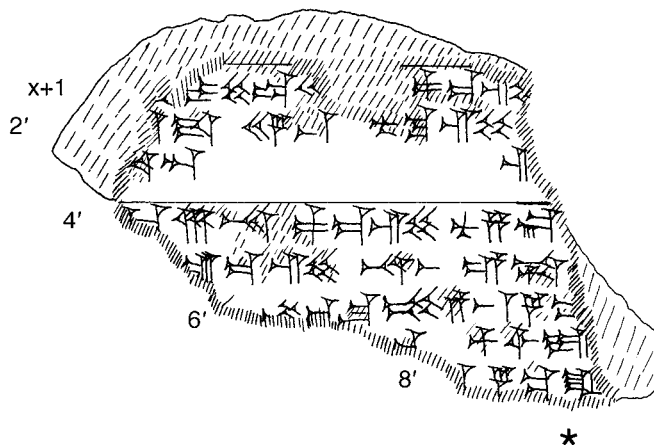

Text 210

AnAr 21632

önyüz / obverse

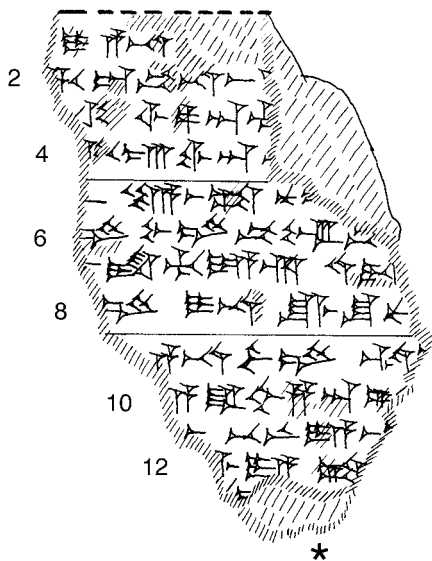

Text 211

AnAr 21633

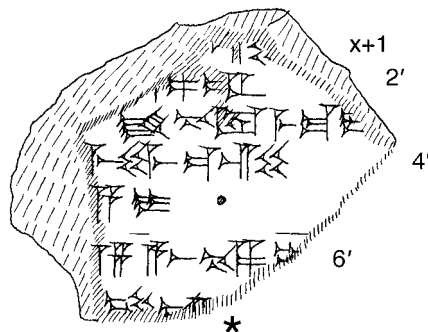

Text 212

AnAr 28-3-66

önyüz / obverse

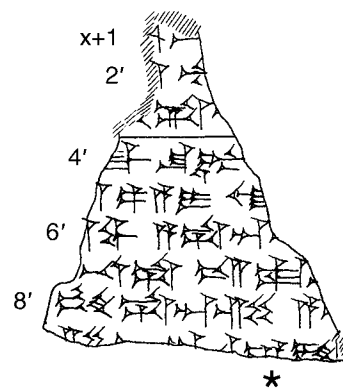

Text 213

AnAr 151-1-67

önyüz / obverse

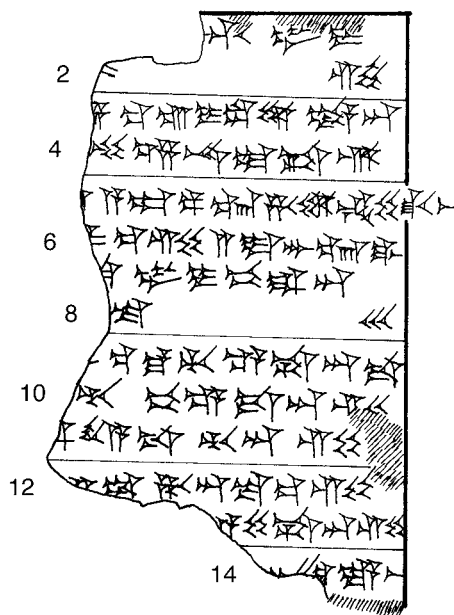

arkayüz / reverse

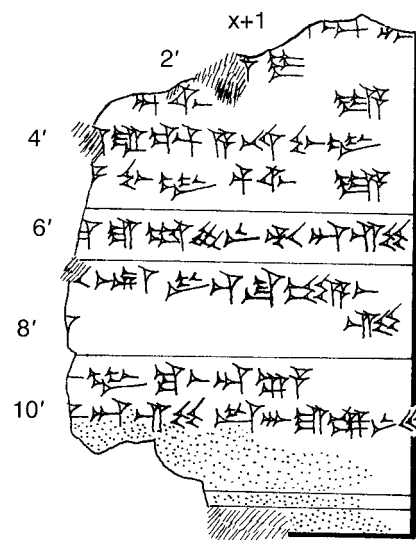

Text 214

AnAr 16-1-68

önyüz / obverse

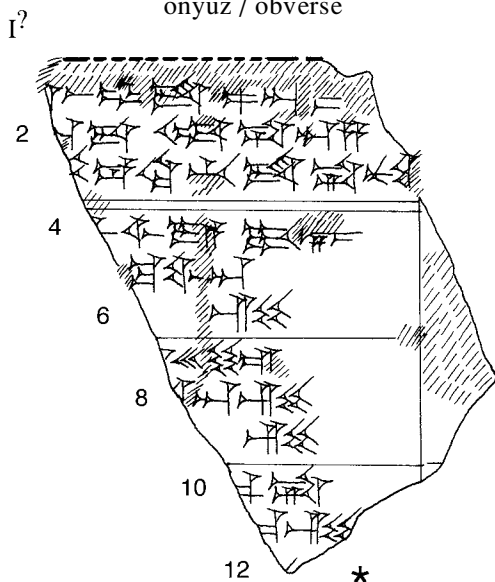

Text 215

AnAr 16-2-68

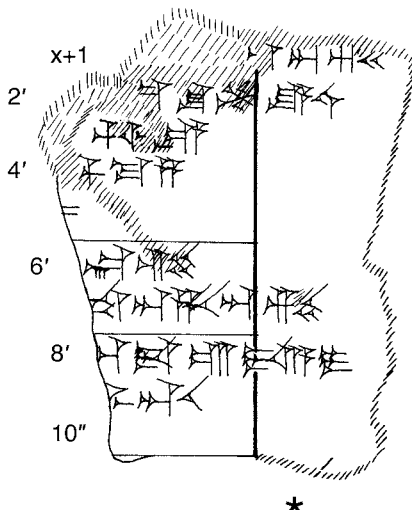

Text 216

AnAr 16-3-68

önyüz / obverse

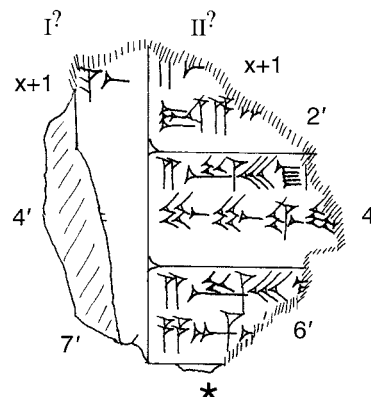

Text 217

AnAr 16-4-68

önyüz / obverse

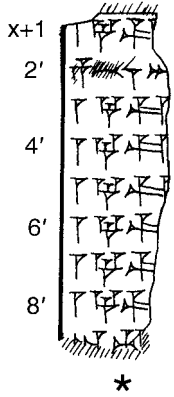

Text 218

AnAr 16-8-68

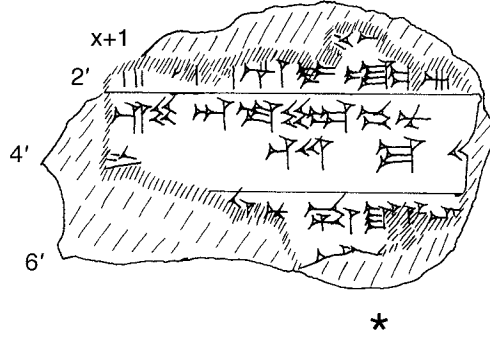

Text 219

AnAr 16-9-68

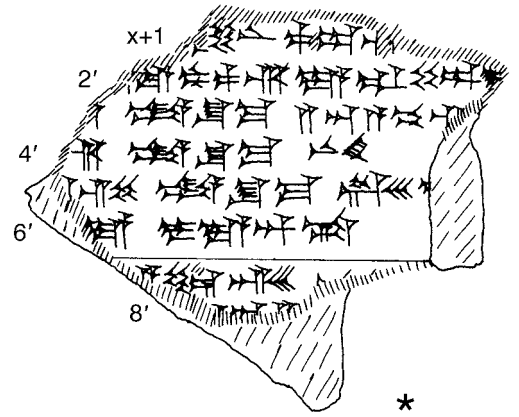

Text 220

AnAr 16-10-68

önyüz / obverse

arkayüz / reverse

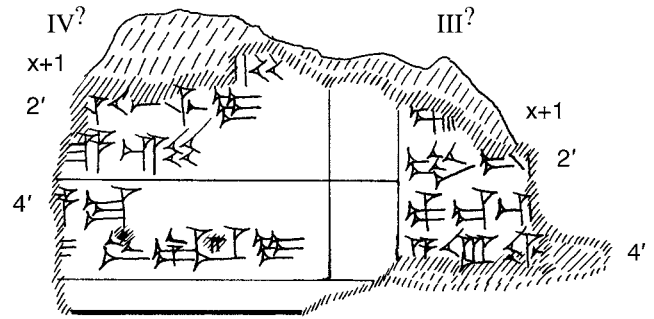
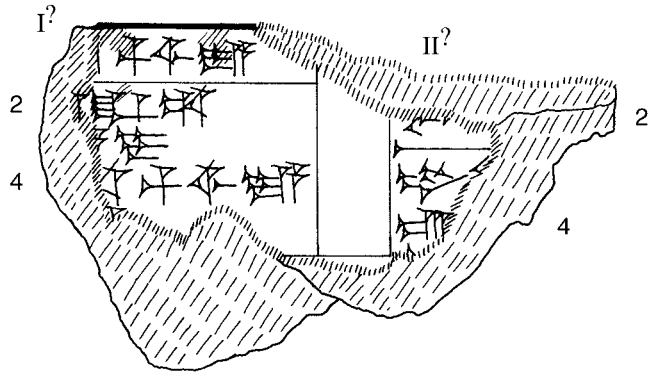

Text 221

AnAr 16-11-68

önyüz / obverse

sol kenar / left edge

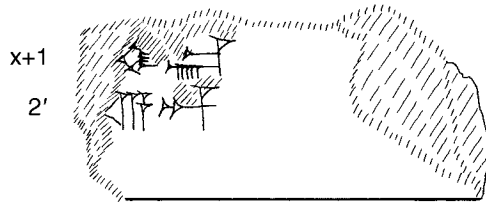
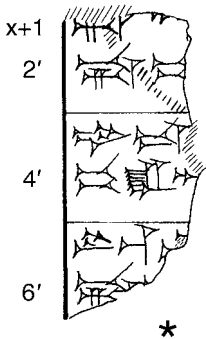

Text 222

AnAr 90-2-68

önyüz / obverse

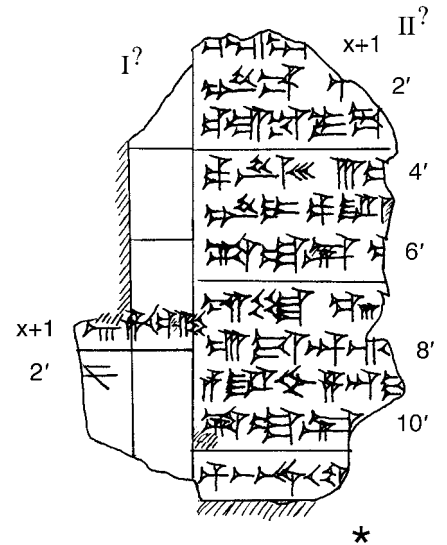

Text 223

AnAr 87-2-06

önyüz / obverse

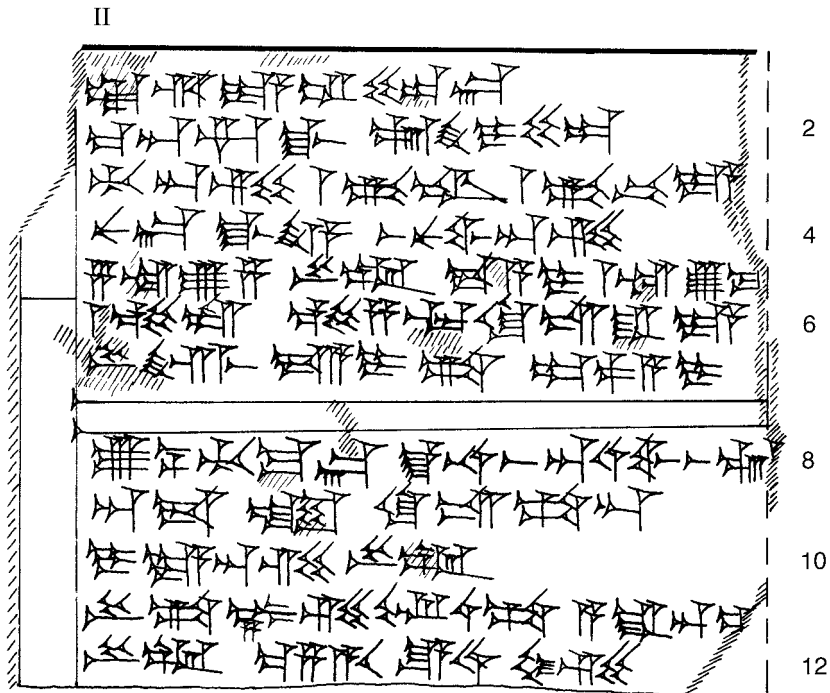

arkayüz / reverse

Text 224

AnAr 4038

önyüz / obverse

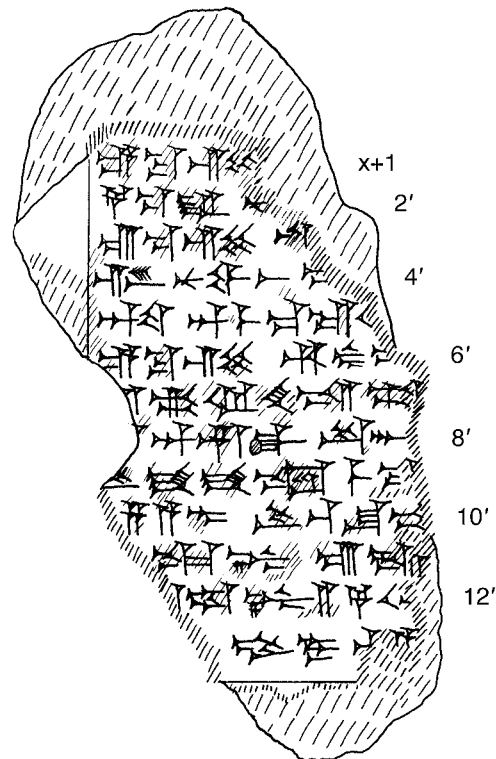

IV

V

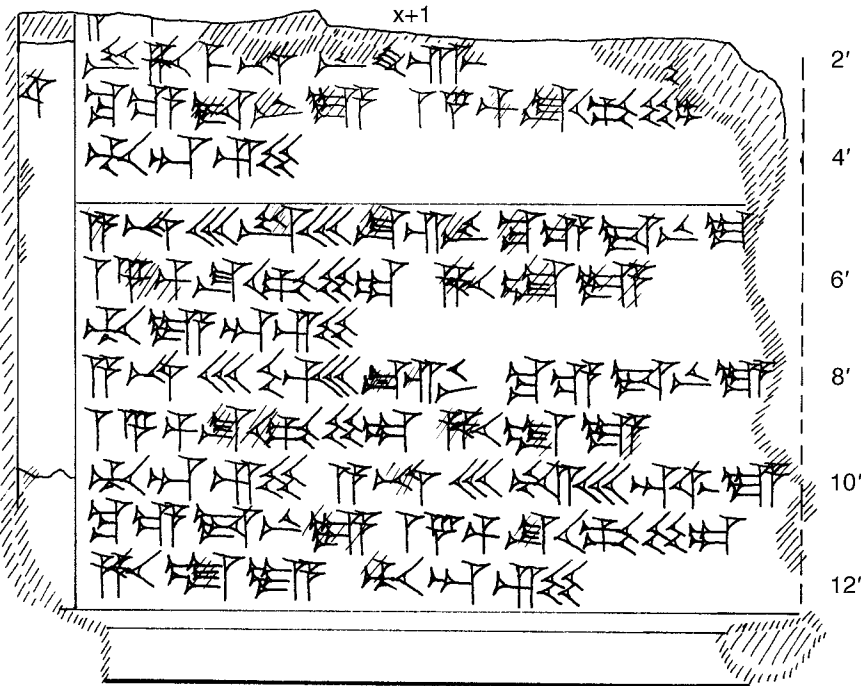

Text 225

AnAr 11619 b

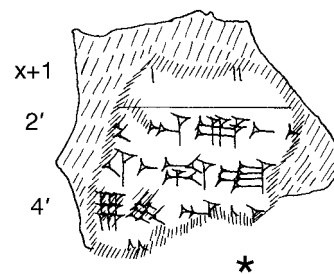

Text 226

AnAr 11202

arkayüz / reverse

önyüz / obverse

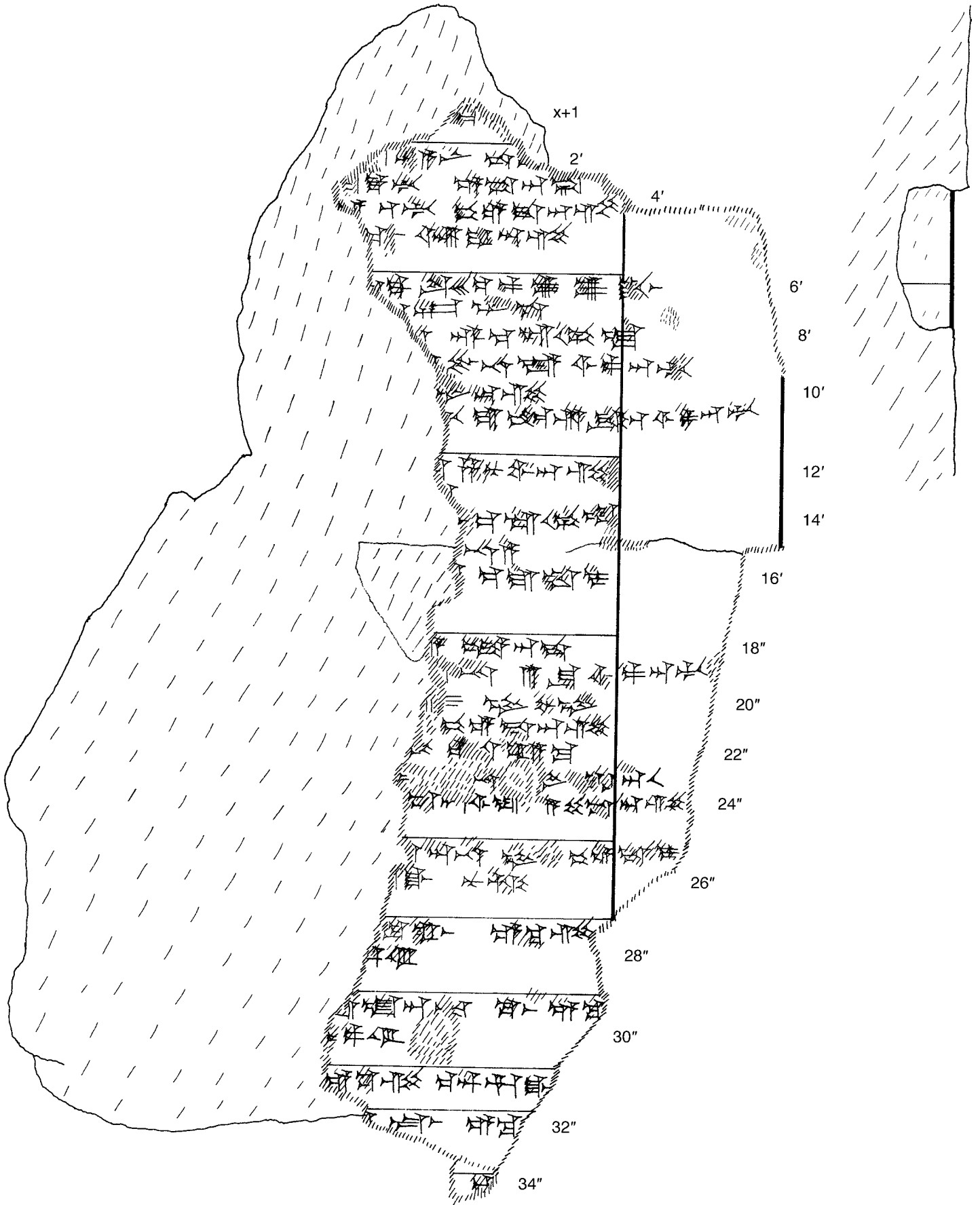

Text 227

AnAr 12131 a

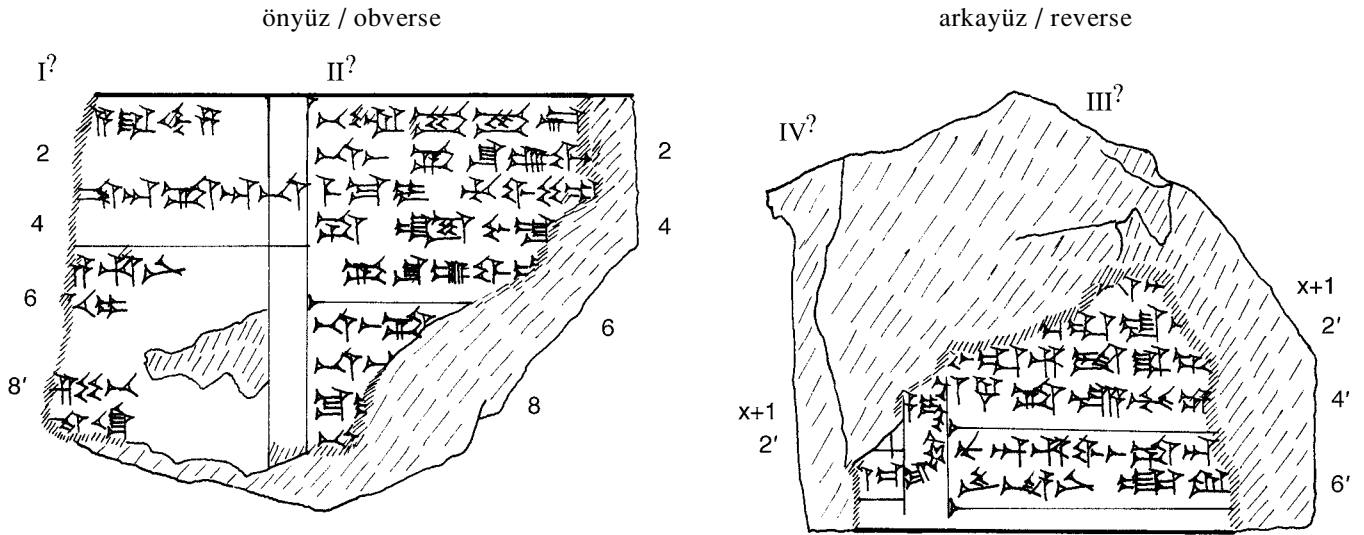

Text 228

AnAr 10307 (+) KBo 29.130

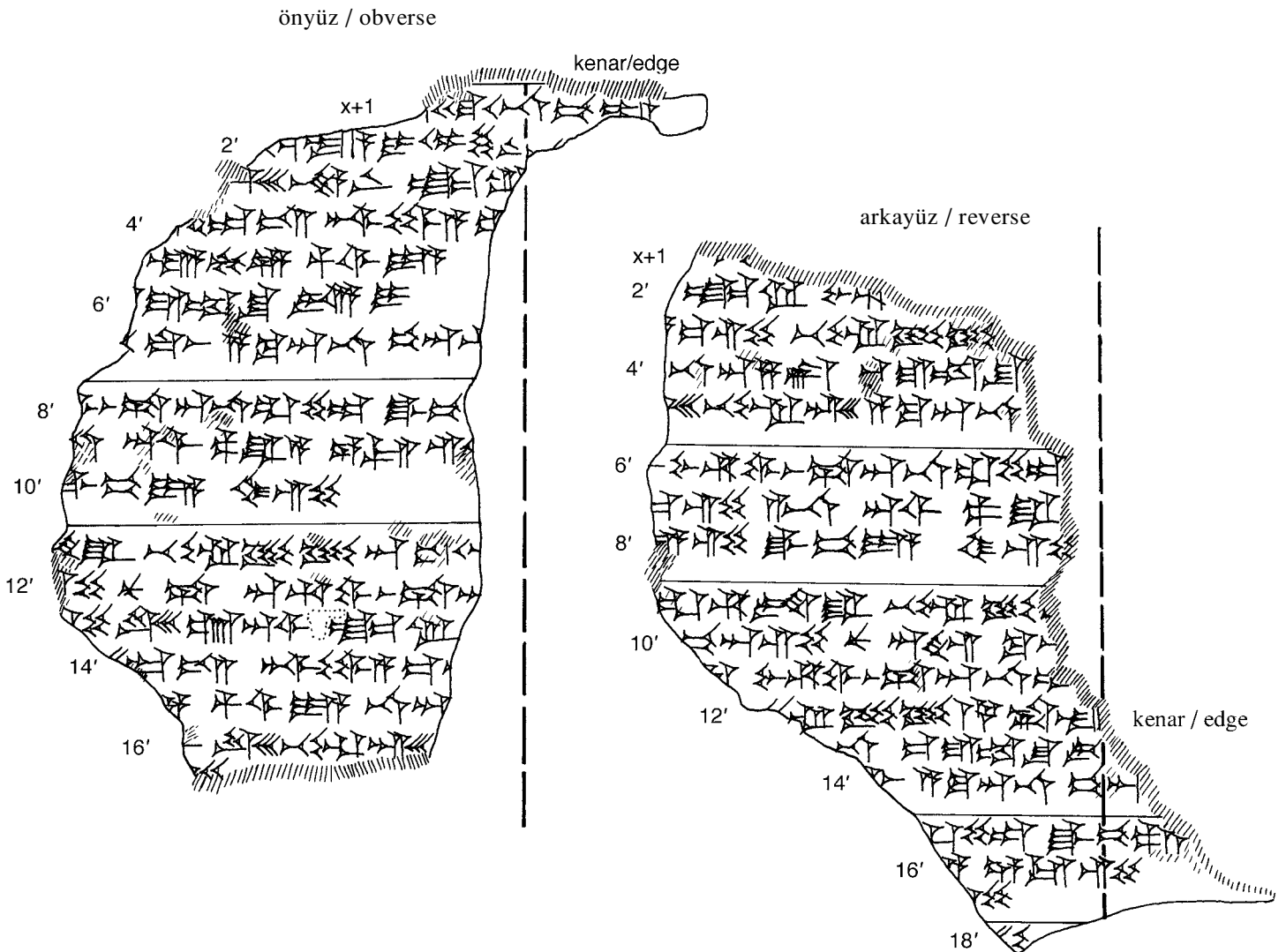

Text 229

AnAr 26-1-68

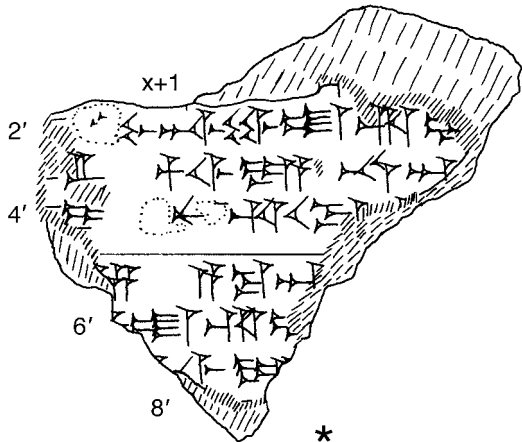

Text 230

AnAr 16-7-68

önyüz / obverse

arkayüz / reverse

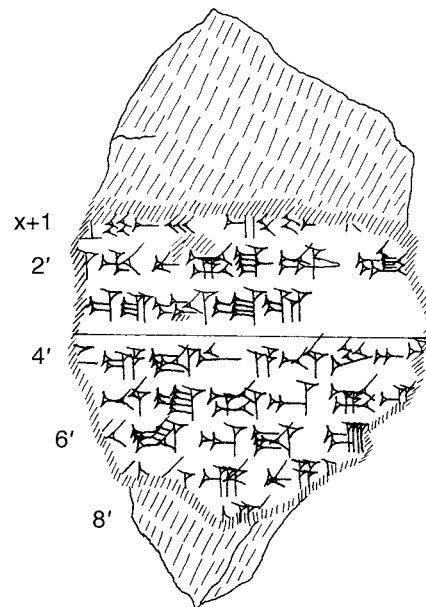
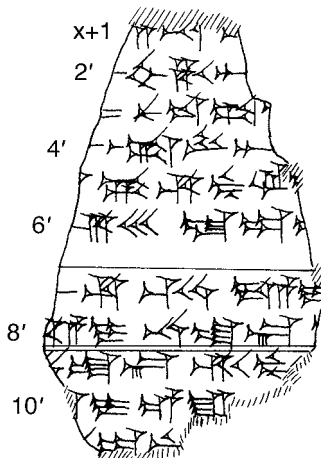

Text 231

AnAr 21629 +KBo 11.5

önyüz / obverse

I

| | | | | | |
|-----|------------------------------------|-------------------------|------------------------|-------|--------------|
| 20' | [EGIR-ŠÚ-m]a | Ha-at-ni | ^D Bi-ša-ša- | | |
| | [EGIR-ŠÚ-m]a | | | AnAr | |
| 22' | [EGIR-Š]Ú-ma | HUR.SAG ^{MEŠ} | | 21629 | |
| | ᵀEGIR ¹ -ŠÚ-ma | ^D U AMAR-ti | | | |
| 24' | EGIR-ŠÚ-ma | GU ⁴ Še-e-ri | | | |
| | EGIR-ŠÚ-ma | HUR.SAG Nam-ni | | | |
| 26' | ᵀEGIR ¹ -ŠÚ-ma | ti-ia-ri | | | |
| | [a-]a-ri mu-ut-ri i-ni | | | | |
| 28' | [I-š]U ² TUŠ-aš e-ku-zi | | | | |
| | [EGI]R-ŠÚ-ma | DINGIR ^{MEŠ} | | | KI.MIN 168/p |
| 30' | [EGIR-Š]Ú-ma | DINGIR ^{MEŠ} | | | KI.MIN |
| | [EGIR-Š]Ú-ma | | | | KI.MIN |
| 32' | [EGIR-ŠÚ-m]a | | | | |
| | [ke-eš-h]i | | | | |
| 34' | []x-aš-ši | | | | |
| | | | | | 189/p |

VI

arkayüz / reverse

| | | | | | |
|---|----------------|---|--|-------|-------|
| | | | | AnAr | |
| | | | | 21629 | |
| | [GIM-a]n-ma | GE ₆ -an-za | | | |
| 2 | [IV T]A-PAL | pa-ir-ra-ša | | | |
| | [LUGAL-u]š-kán | QA-TAM da-a-i | | | |
| 4 | x x-za | II MÁŠ.GAL II TA-PAL | | | |
| | [A-N]A | DINGIR ^{MEŠ} LÚ ^{MEŠ} | | | 189/p |
| 6 | [LUGA]L-uš | | | | |

Text 232

AnAr 9150

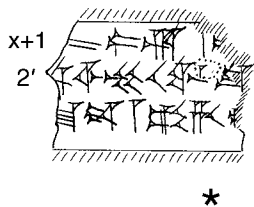

Text 233

AnAr 12168

arkayüz? / reverse?

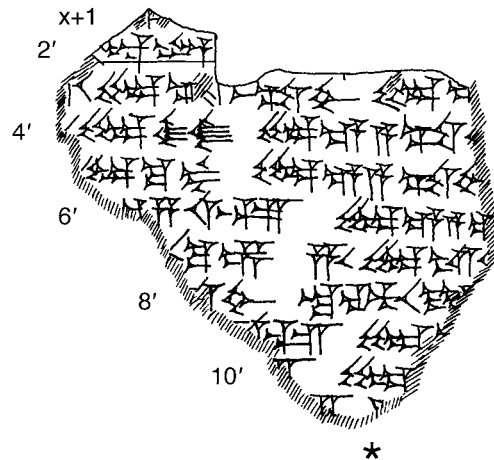

Text 234

AnAr 3136

önyüz / obverse

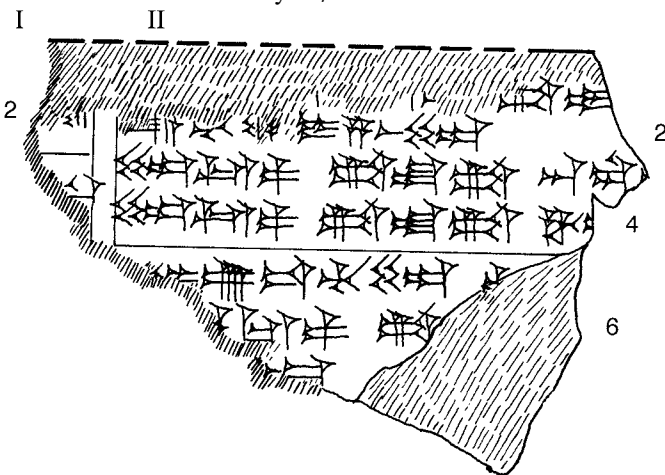

arkayüz / reverse

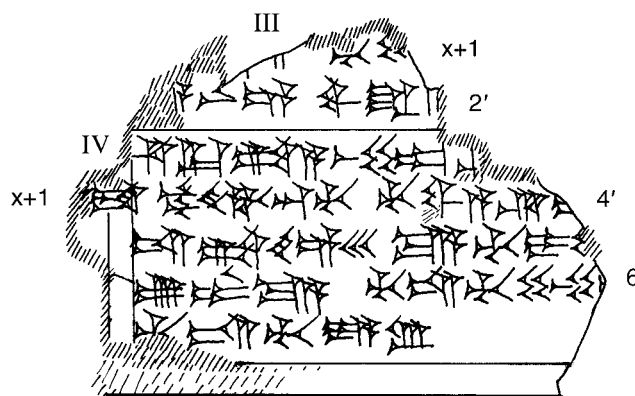

Text 235

AnAr 10610

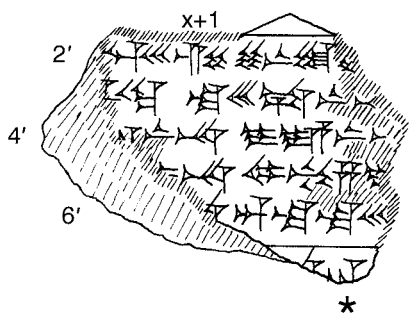

Text 236

AnAr 12175

önyüz / obverse

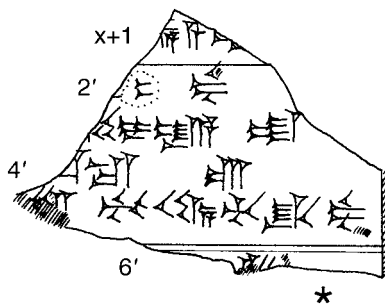

Text 237

AnAr 11502 b

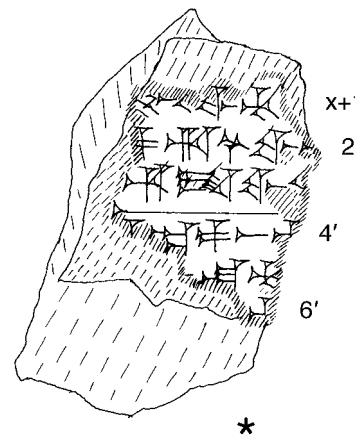

Text 238

AnAr 8918

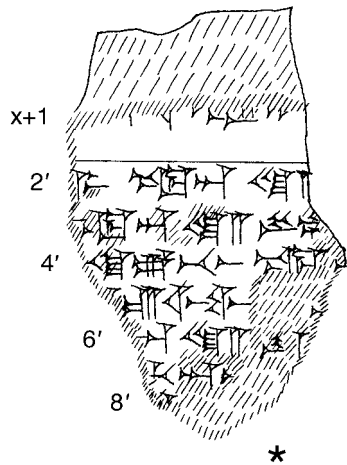

Text 240

AnAr 14917

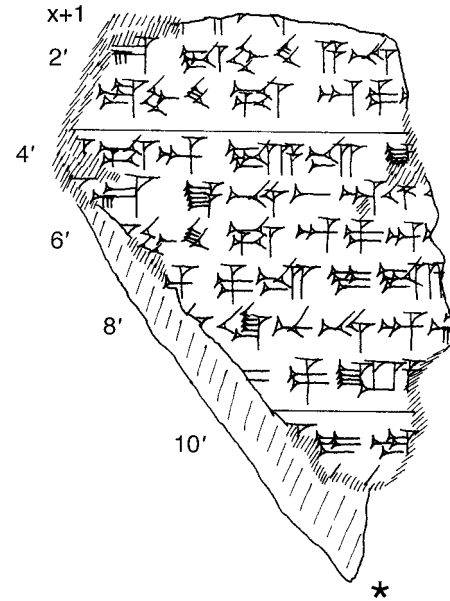

Text 239

AnAr 11621 d+g

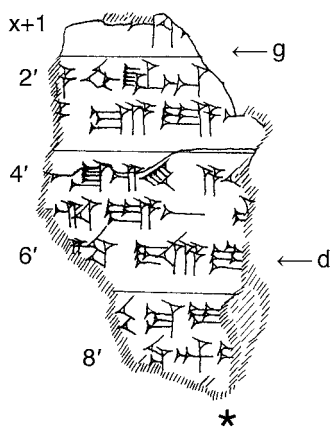

Text 241

AnAr 14839a

önyüz / obverse

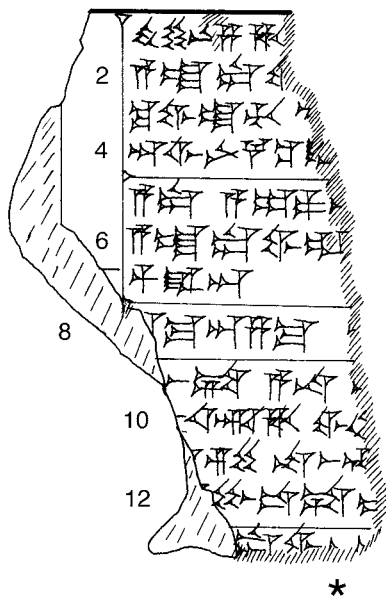

Text 242

AnAr 14914

önyüz / obverse

sol kenar / left edge

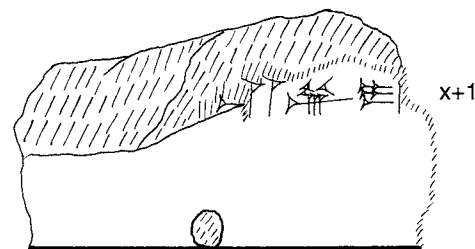
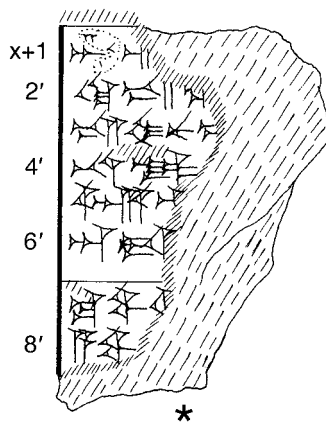

Text 243

AnAr 9251

önyüz / obverse

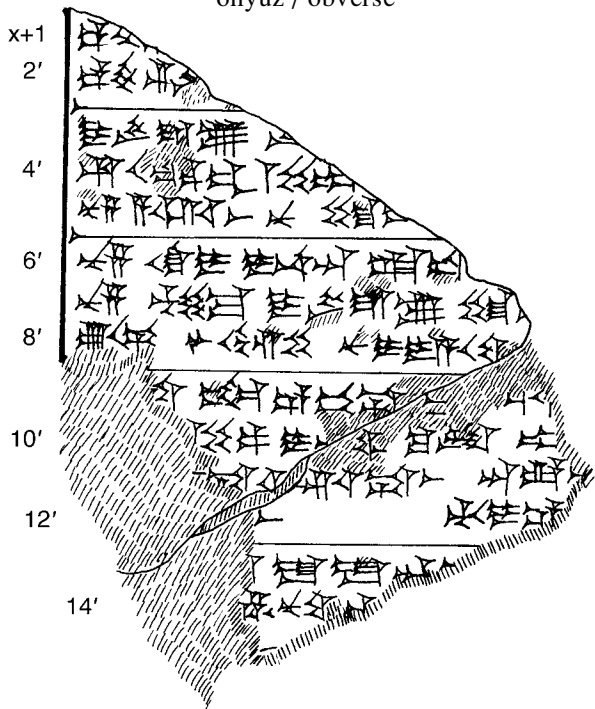

arkayüz / reverse



Text 244

AnAr 12170

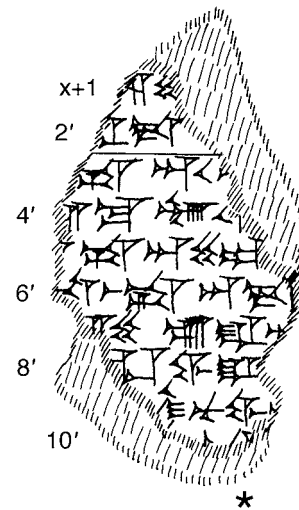

Text 245

AnAr 10319

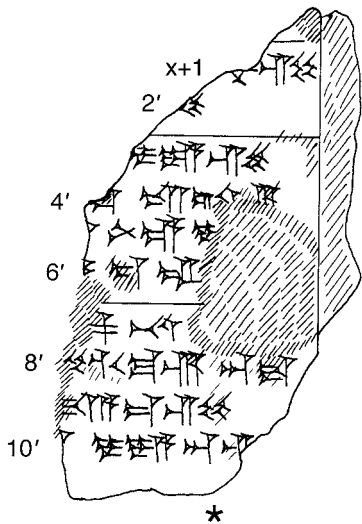

Text 246

AnAr 12131 c

önyüz / obverse

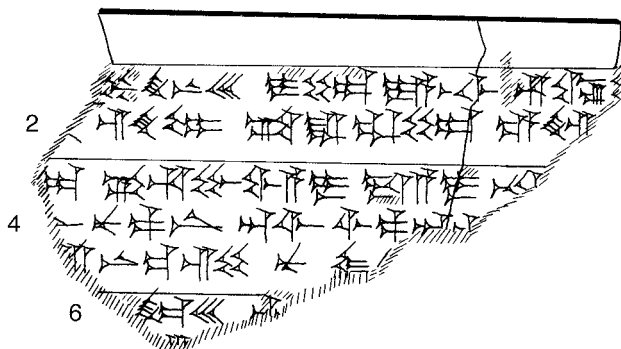

Text 247

AnAr 42-2-66

önyüz / obverse

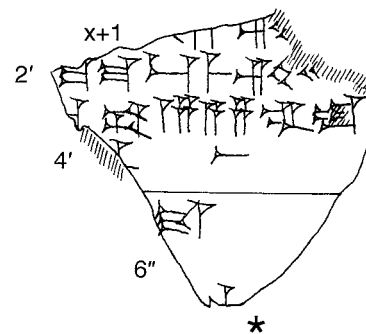

arkayüz / reverse

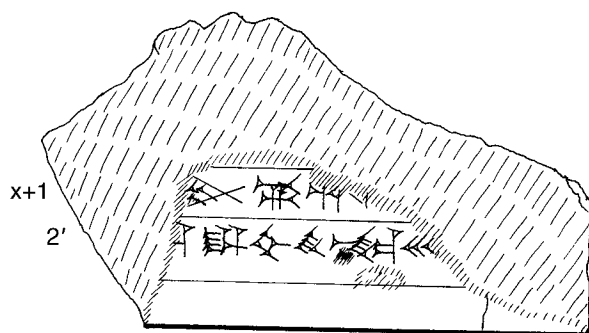

Text 248

AnAr 14918

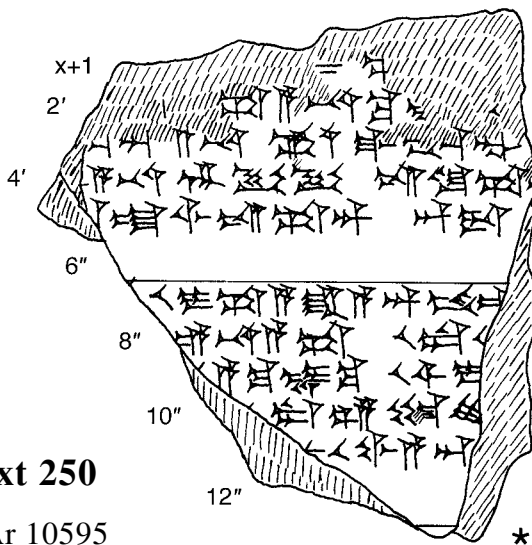

Text 250

AnAr 10595

önyüz / obverse

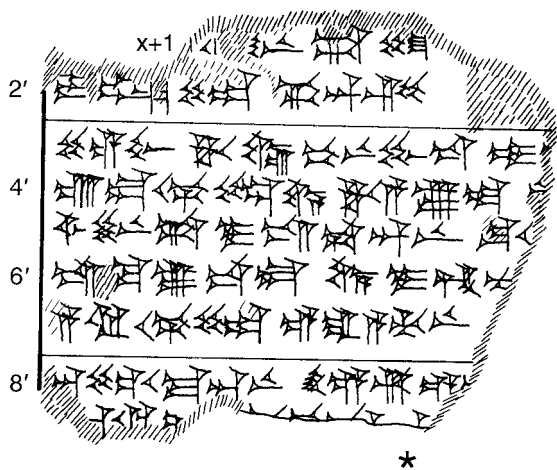

Text 252

AnAr 12155

önyüz / obverse

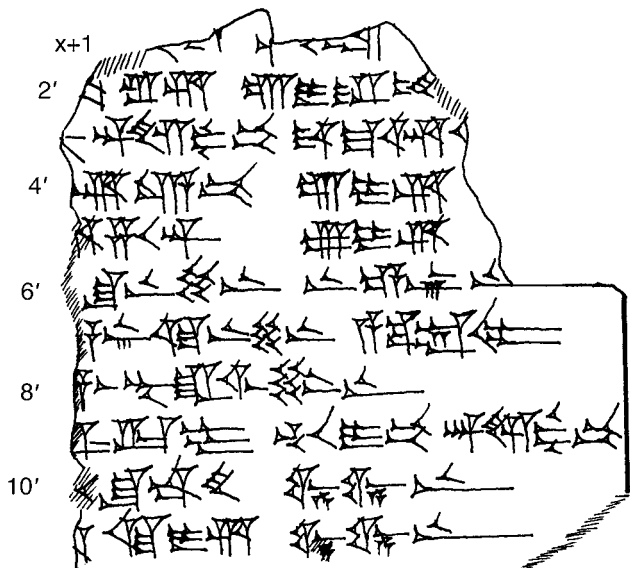

Text 249

AnAr 10318

önyüz / obverse

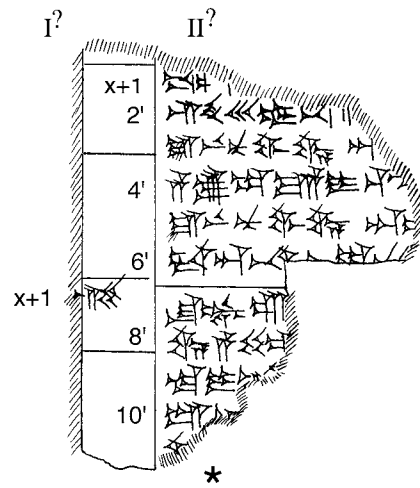

Text 251

AnAr 11616 a

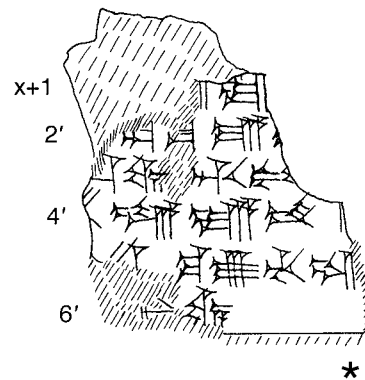

arkayüz / reverse

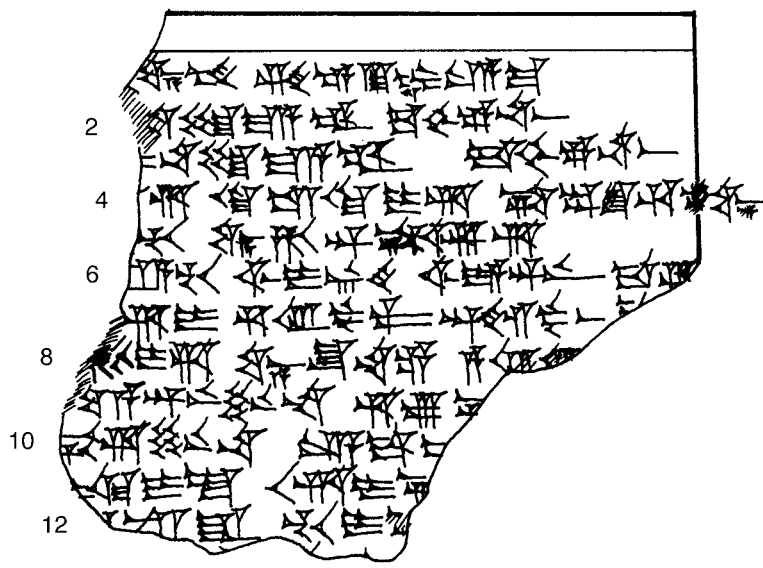

Text 253

AnAr 8915

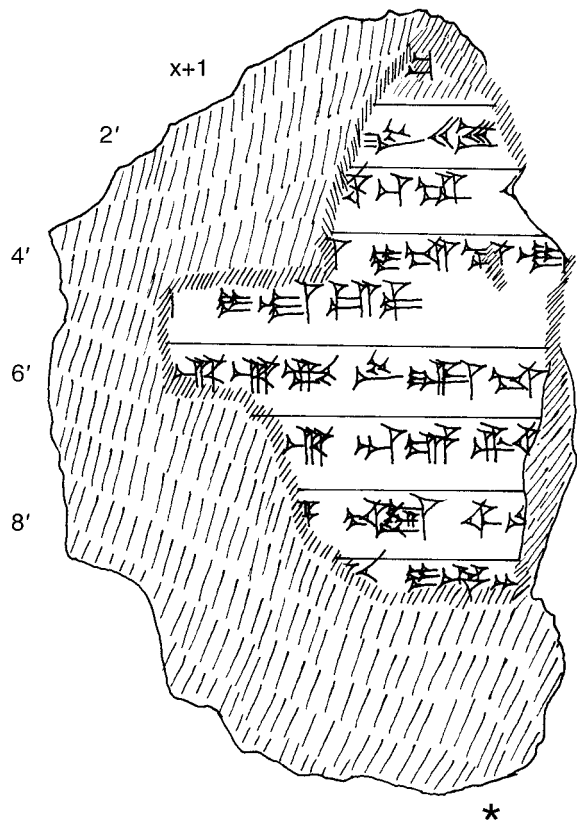

Text 254

AnAr 8917

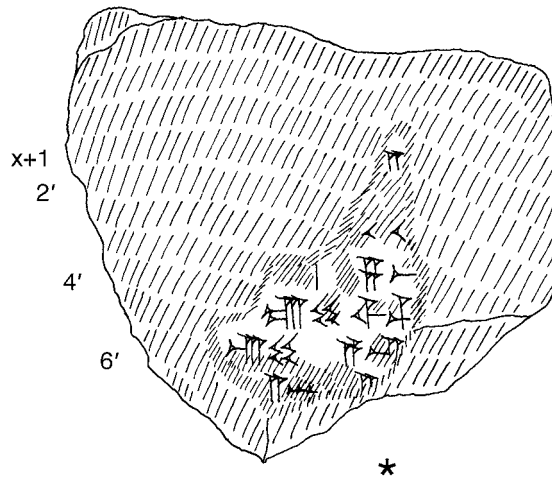

Text 256

AnAr 10321

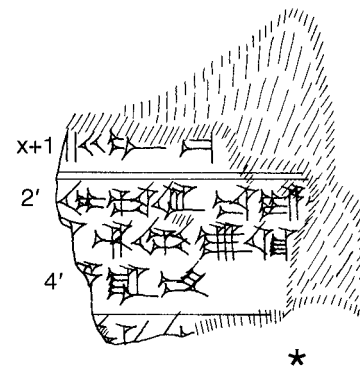

Text 255

AnAr 9167

arkayüz / reverse

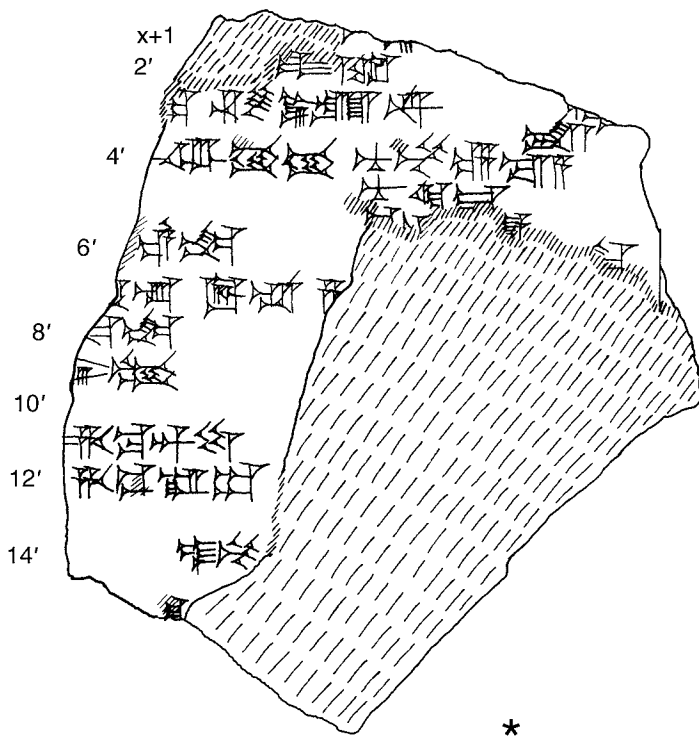

Text 257

AnAr 8360 d

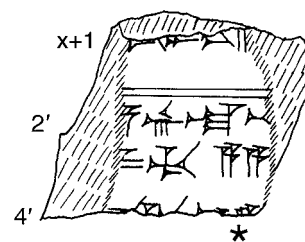

Text 258

AnAr 10873

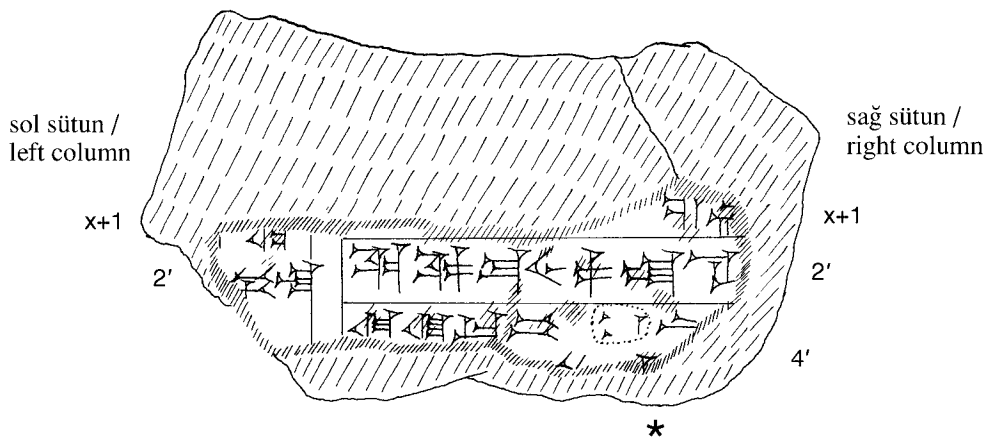

Text 259

AnAr 11246 1

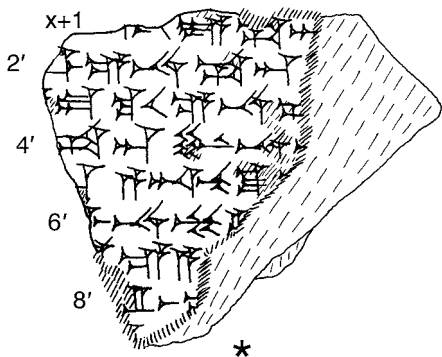

Text 260

AnAr 11617 b

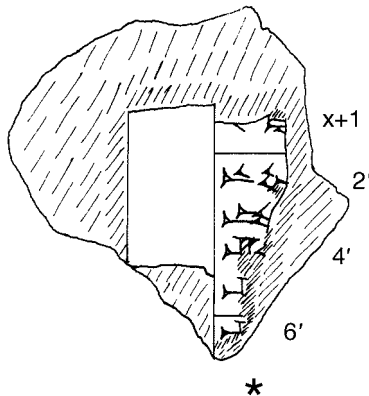

Text 261

AnAr 11616 c

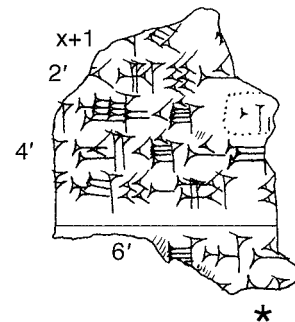

Text 262

AnAr 11619 c+e

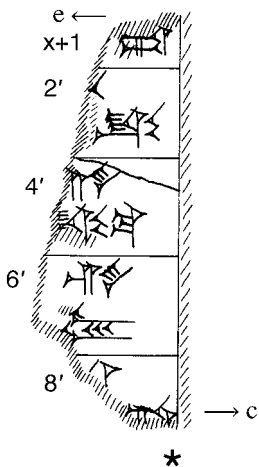

Text 263

AnAr 14935

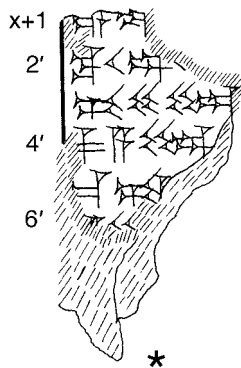

Text 264

AnAr 6966

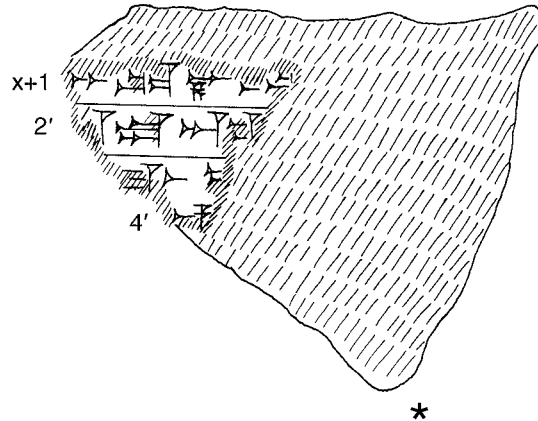

Text 265

AnAr 6968

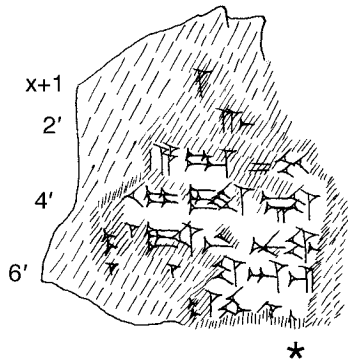

Text 266

AnAr 6988

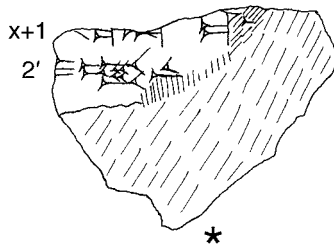

Text 267

AnAr 6996

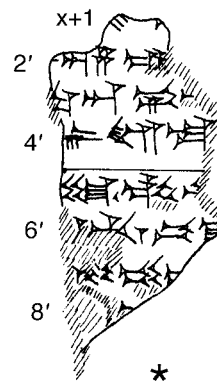

Text 268

AnAr 7002

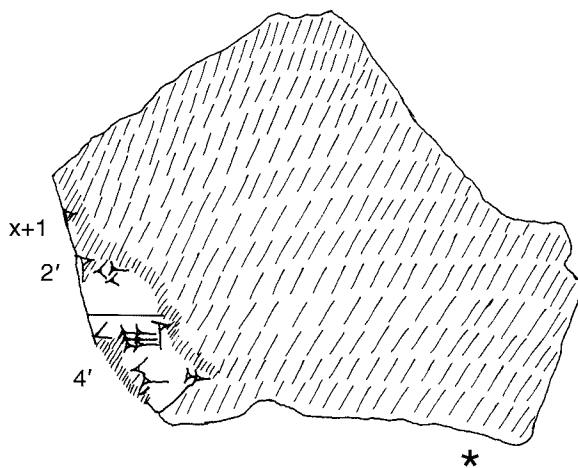

Text 269

AnAr 7004

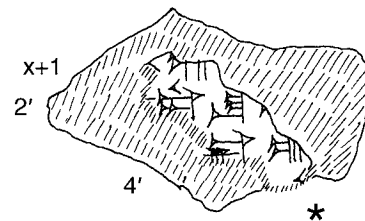

Text 270

AnAr 8354

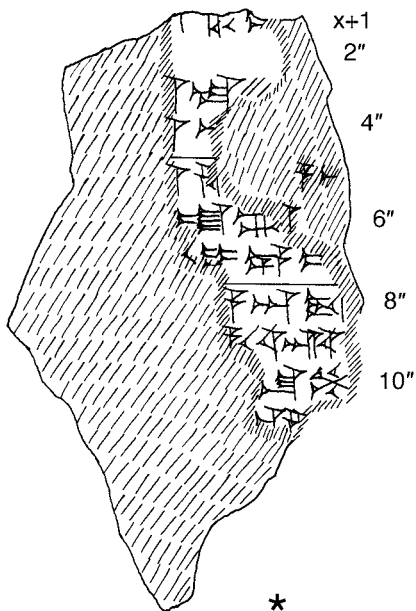

Text 271

AnAr 8355

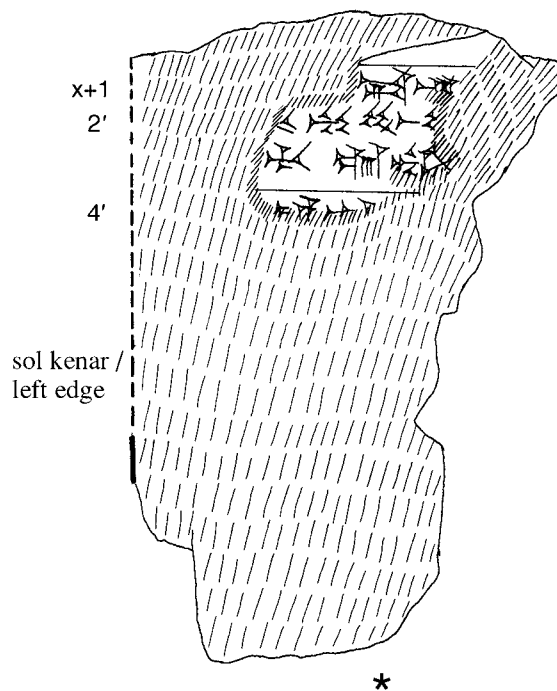

Text 272

AnAr 8358 c

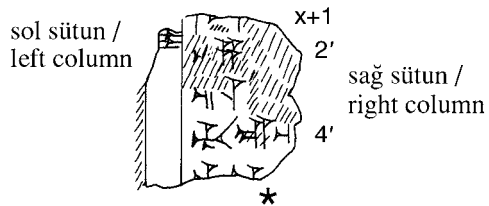

Text 273

AnAr 8360 b

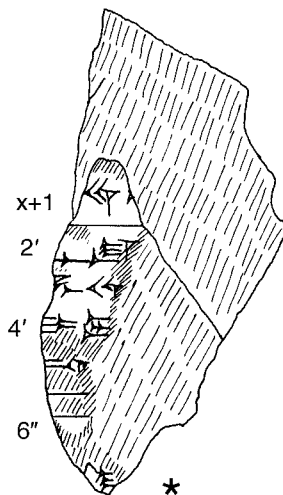

Text 274

AnAr 8360 ç
önyüz / obverse

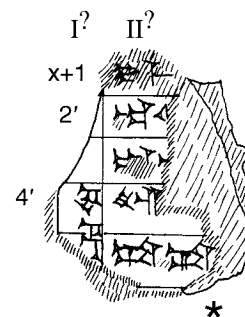

Text 275

AnAr 8360 e
önyüz / obverse

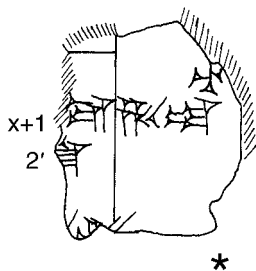

Text 276

AnAr 8360 g

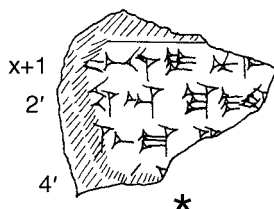

Text 277

AnAr 8360 j

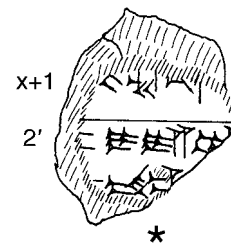

Text 278

AnAr 8360 k

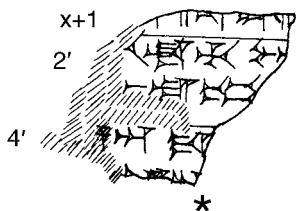

Text 279

AnAr 8360 r

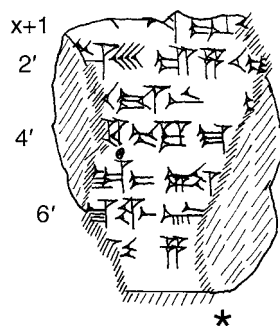

Text 280

AnAr 8364
arkayüz / reverse

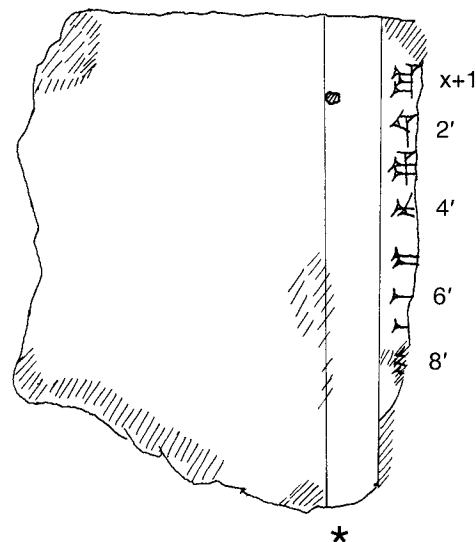

Text 281

AnAr 8365 a

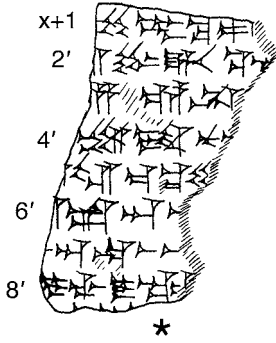

Text 282

AnAr 8365 ç

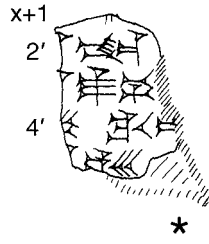

Text 283

AnAr 8365 ğ

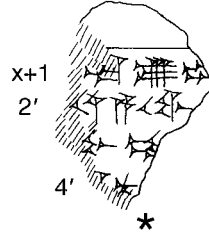

Text 284

AnAr 8844 a

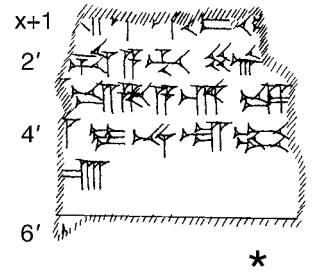

Text 285

AnAr 8844 c

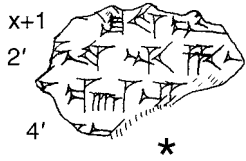

Text 286

AnAr 8845

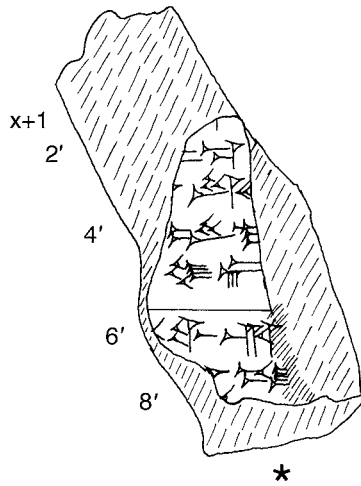

Text 287

AnAr 8846

önyüz / obverse

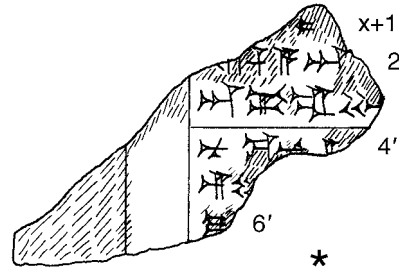

Text 288

AnAr 8850

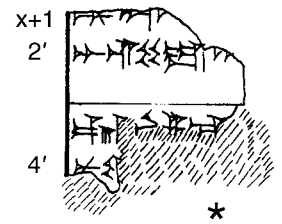

Text 289

AnAr 8852

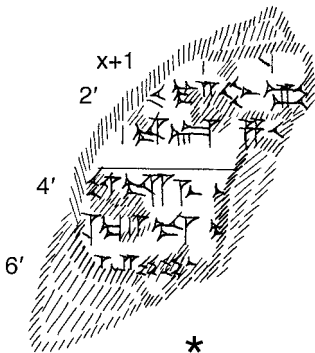

Text 290

AnAr 8853

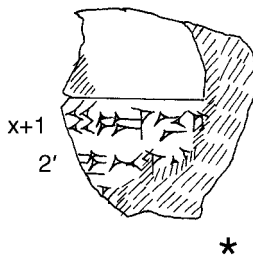

Text 291

AnAr 8856

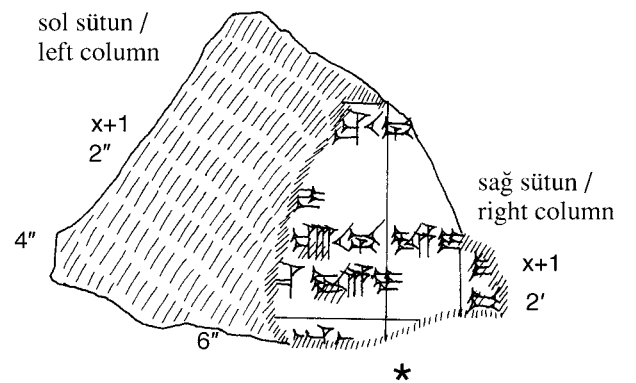

Text 292

AnAr 8913
önyüz / obverse

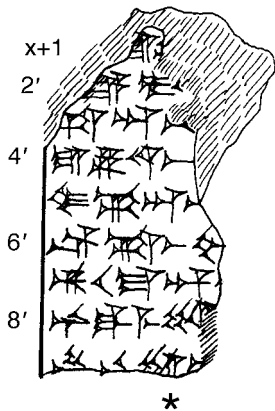

Text 293

AnAr 8920

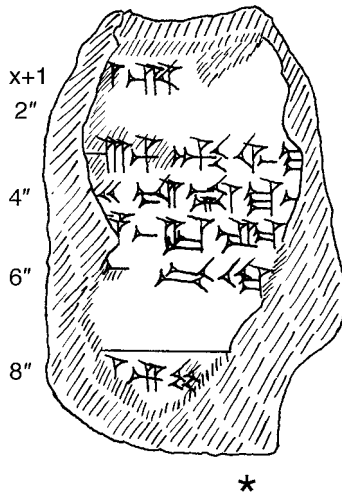

Text 294

AnAr 8921

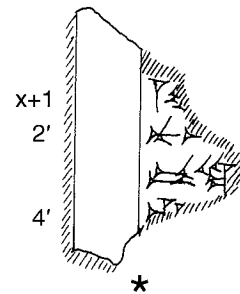

Text 295

AnAr 8922

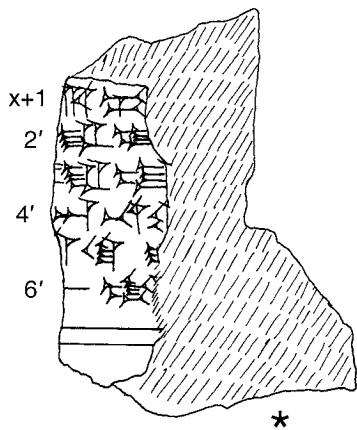

Text 296

AnAr 9143

önyüz / obverse

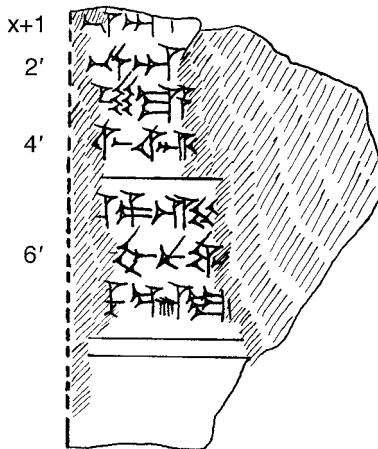

arkayüz / reverse

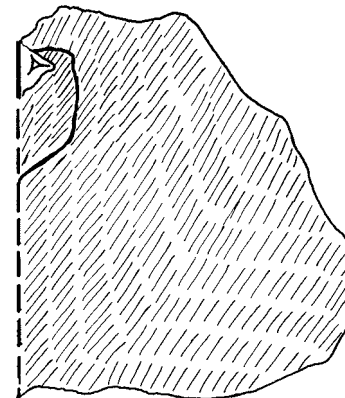

Text 297

AnAr 9144
arkayüz / reverse

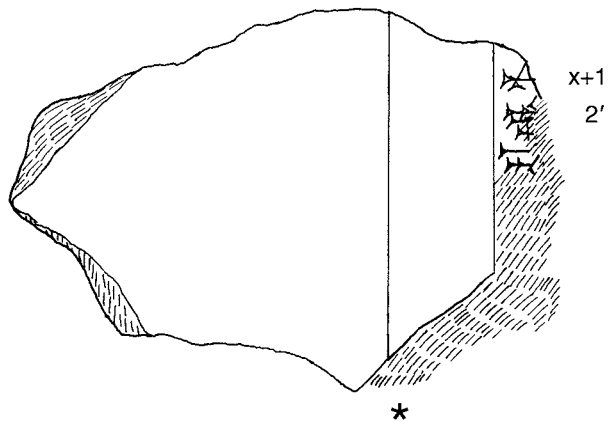

Text 298

AnAr 9460

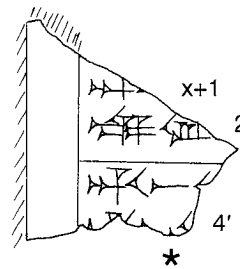

Text 299

AnAr 9461

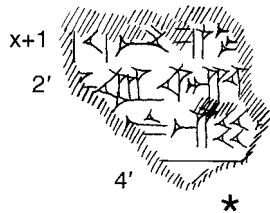

Text 300

AnAr 9462

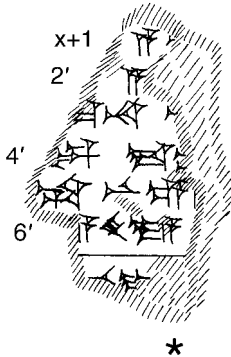

Text 301

AnAr 9463

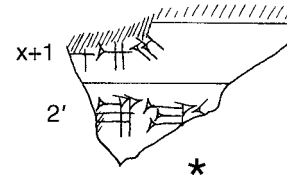

Text 302

AnAr 9467

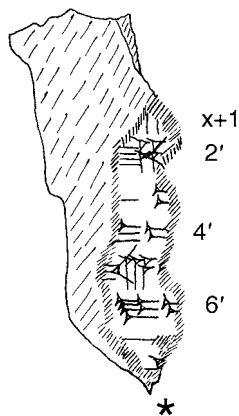

Text 303

AnAr 9470

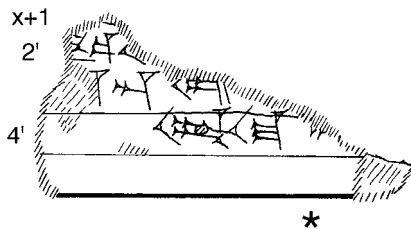

Text 304

AnAr 9718

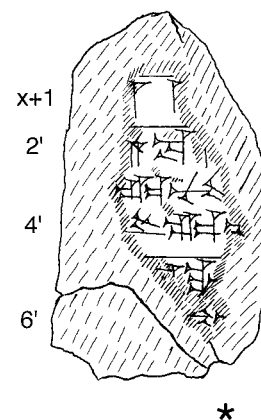

Text 305

AnAr 9719

arkayüz / reverse

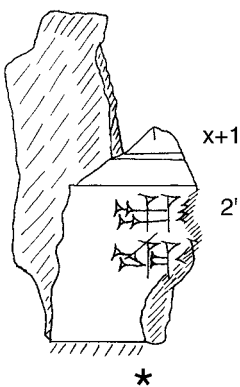

Text 306

AnAr 9728

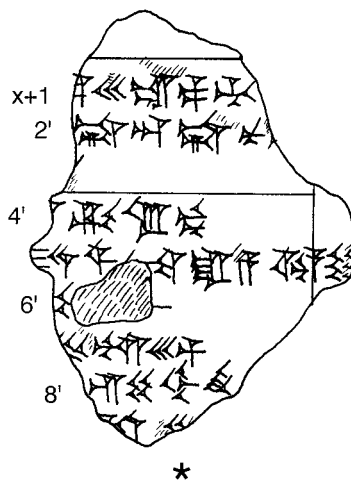

Text 307

AnAr 9729

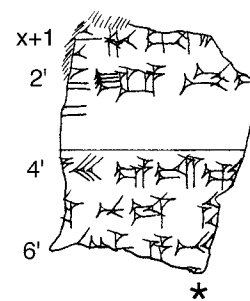

Text 308

AnAr 9731

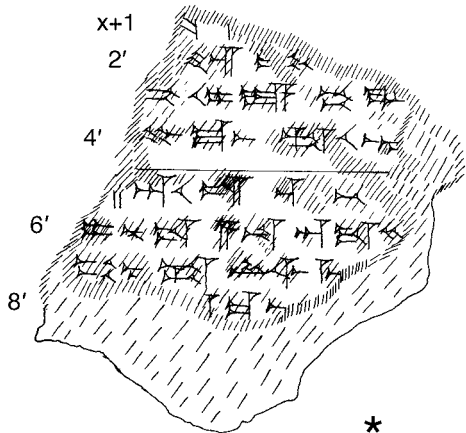

Text 309

AnAr 9732

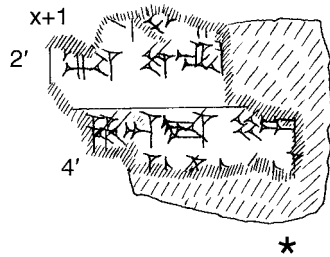

Text 310

AnAr 10314

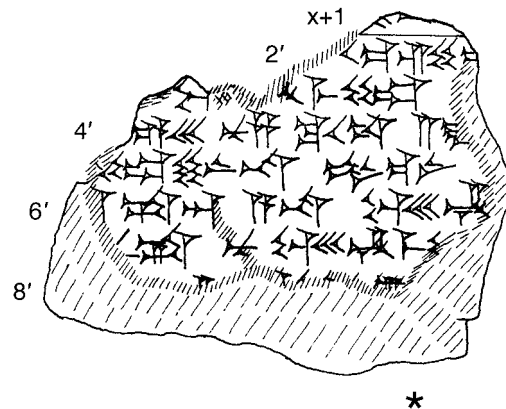

Text 311

AnAr 10316

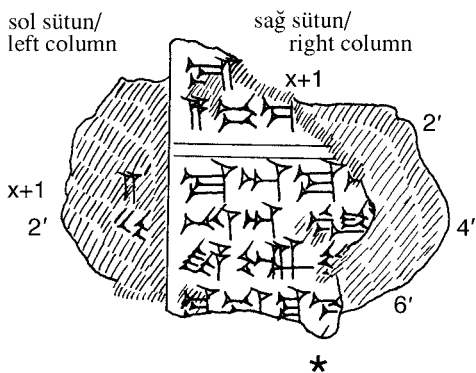

Text 312

AnAr 10317

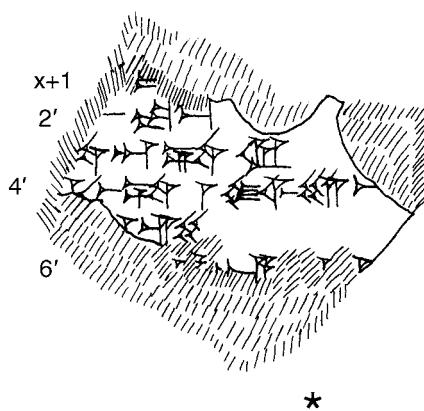

Text 313

AnAr 10323

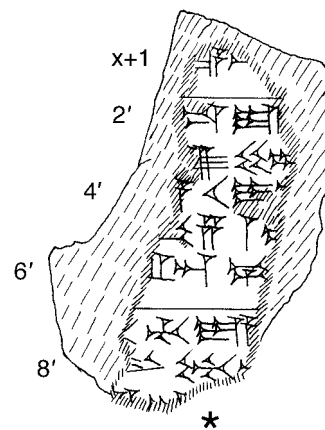

Text 314

AnAr 10324

arkayüz / reverse

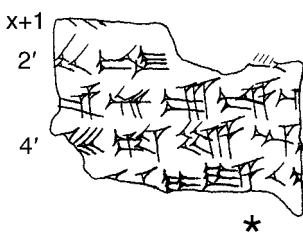

Text 315

AnAr 10601 a

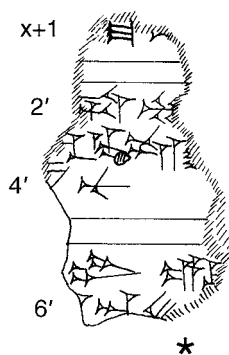

Text 316

AnAr 10601 b

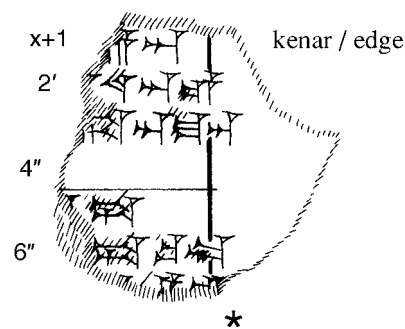

Text 317

AnAr 10607

önyüz / obverse

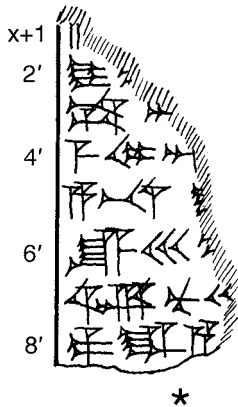

Text 318

AnAr 10608

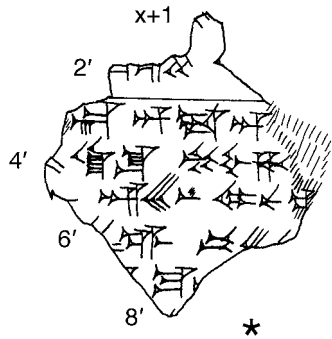

Text 319

AnAr 10759

önyüz / obverse

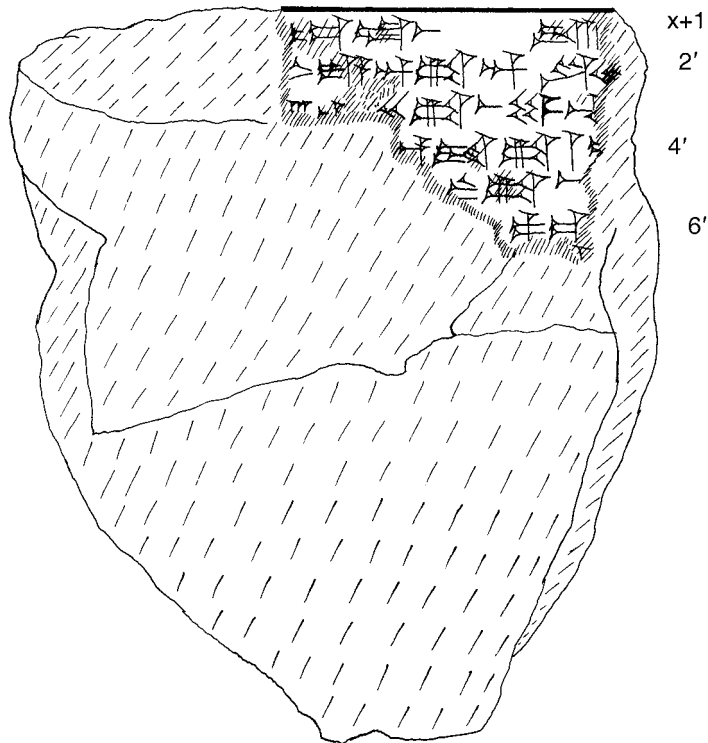

Text 320

AnAr 11240 a

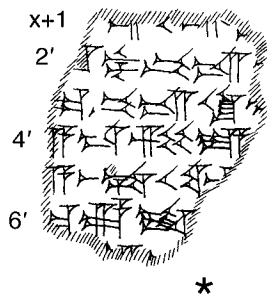

arkayüz / reverse

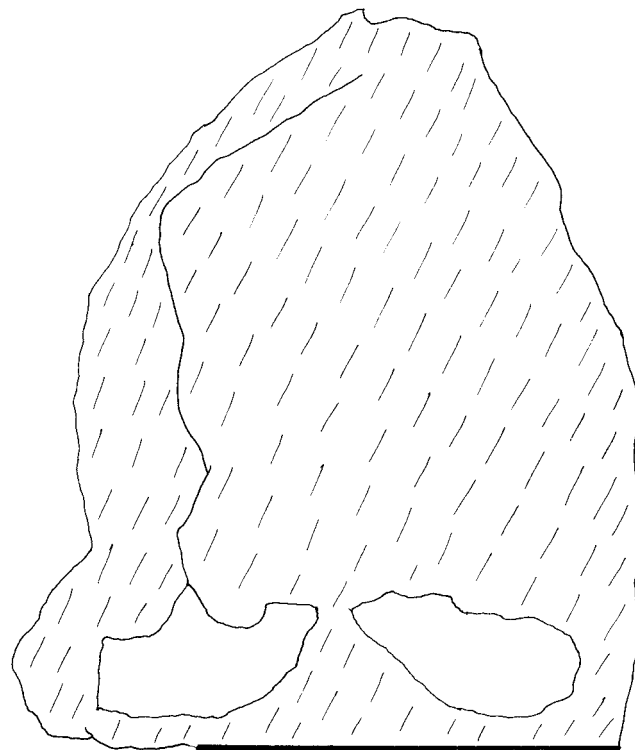

Text 321

AnAr 11240 b

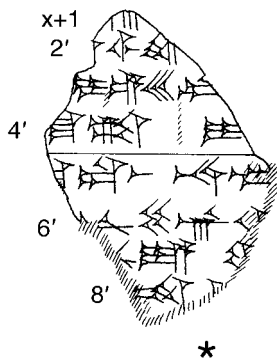

Text 322

AnAr 11246 f

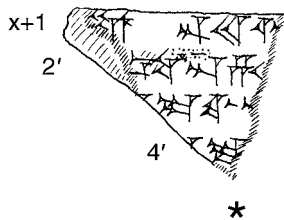

yazısız / unscribed

Text 323

AnAr 11246 i

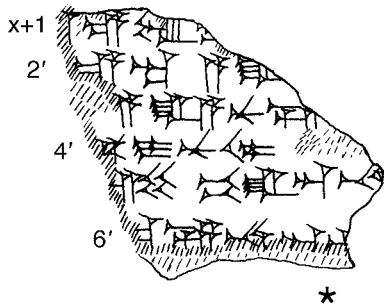

Text 324

AnAr 11385 a
önyüz / obverse

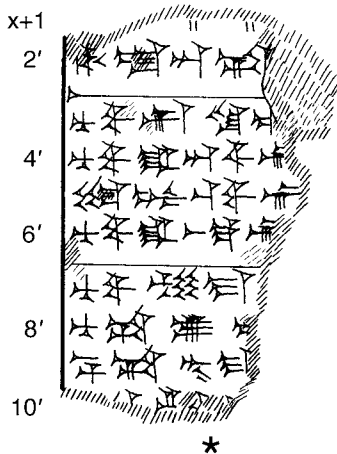

Text 325

AnAr 11390

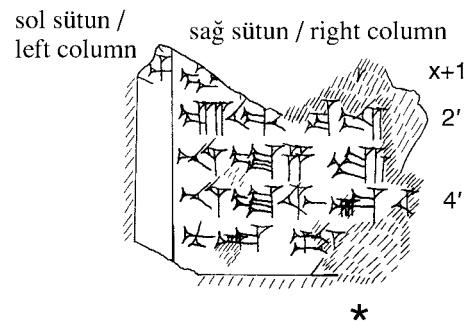

Text 326

AnAr 11392
arkayüz? / reverse?

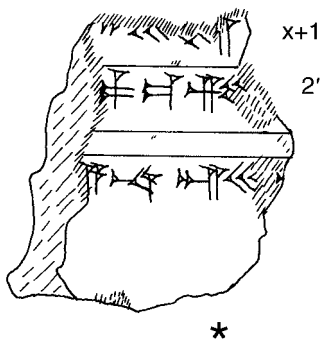

Text 327

AnAr 11393

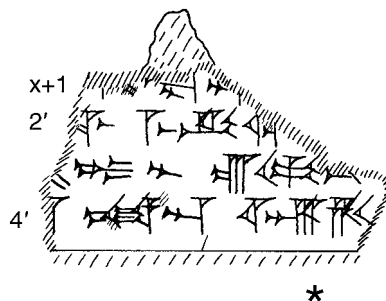

Text 328

AnAr 11404

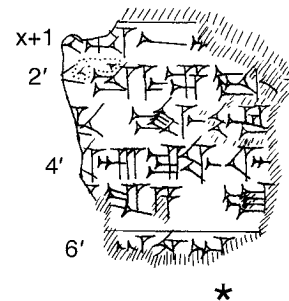

Text 329

AnAr 11500

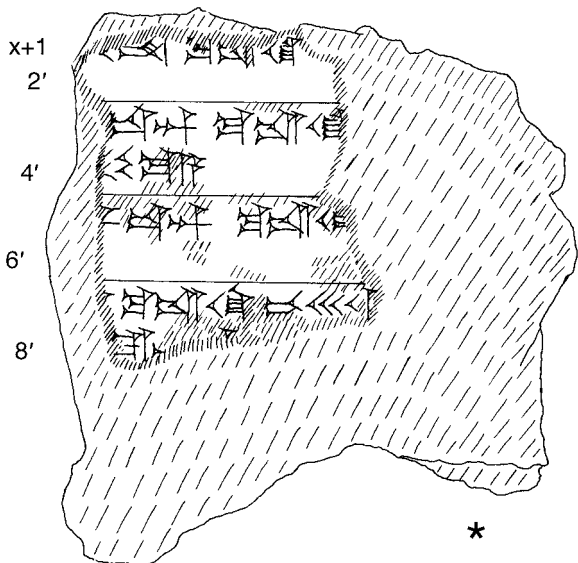

Text 330

AnAr 11617 a

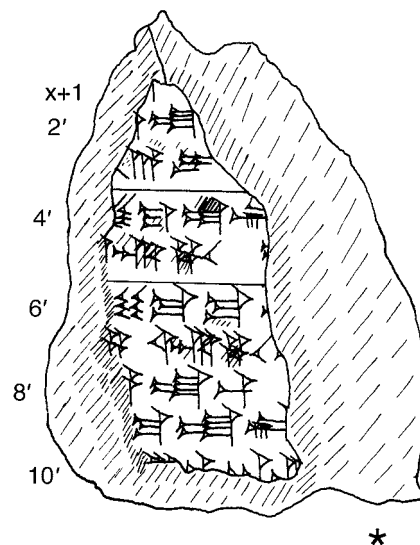

Text 331

AnAr 11621 e

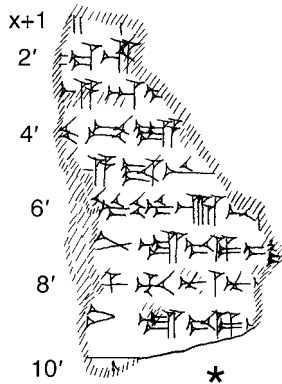

Text 332

AnAr 12131 g

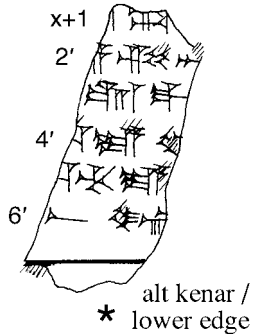

Text 333

AnAr 12163
arkayüz? / reverse?

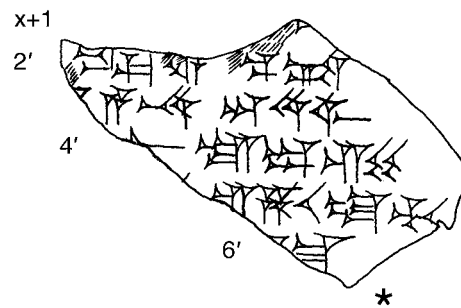

Text 334

AnAr 12180

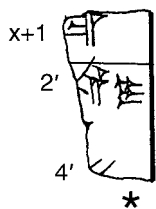

Text 335

AnAr 12181

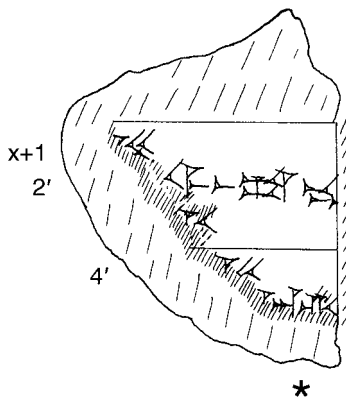

Text 336

AnAr 12182

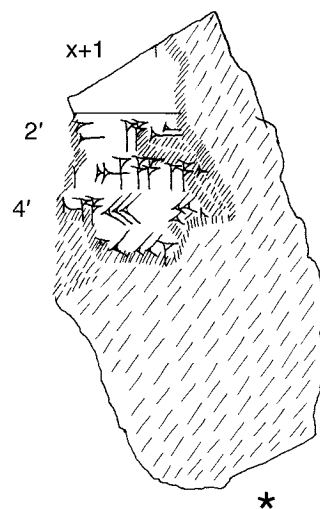

Text 337

AnAr 12189

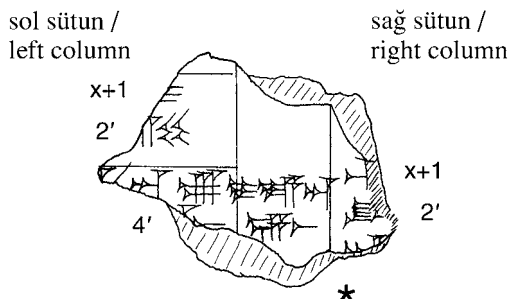

Text 338

AnAr 12196

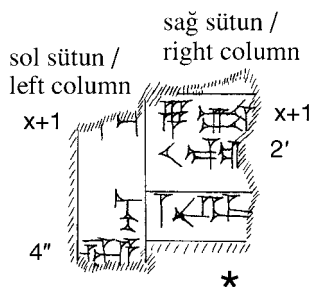

Text 339

AnAr 12197

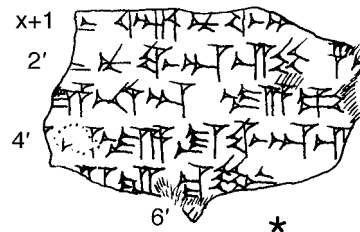

Text 340

AnAr 14455

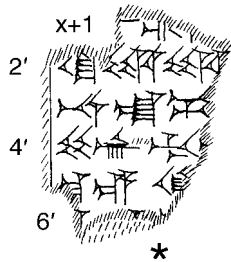

Text 341

AnAr 14924

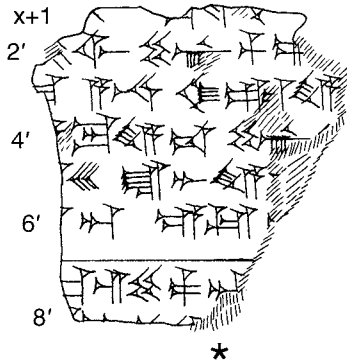

Text 342

AnAr 14925

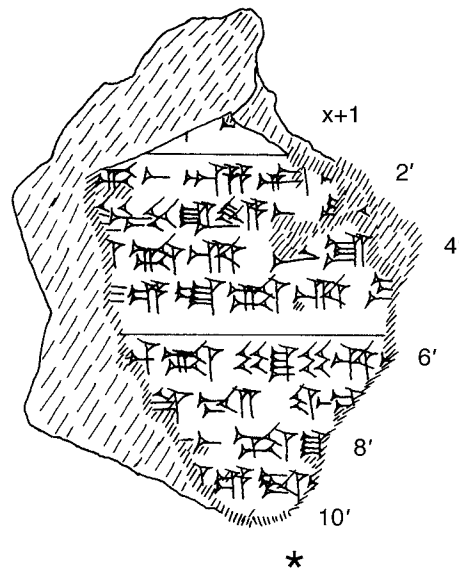

Text 343

AnAr 14929

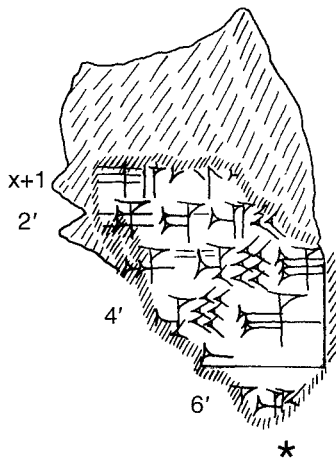

Text 344

AnAr 14930

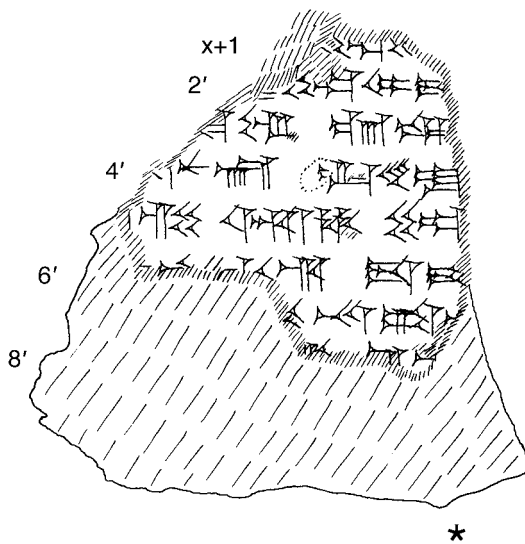

Text 345

AnAr 14937

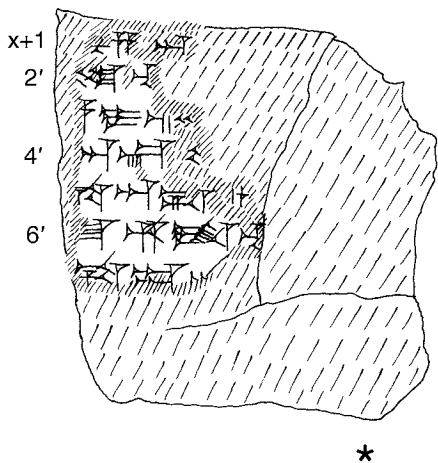

Text 346

AnAr 14938

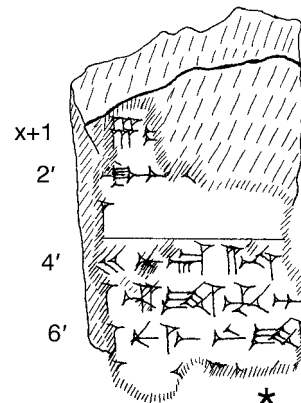

Text 347

AnAr 14941

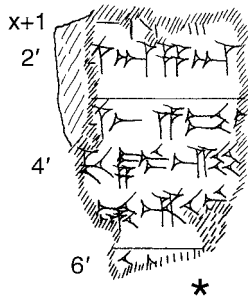

Text 348

AnAr 14944

önyüz / obverse

arkayüz / reverse

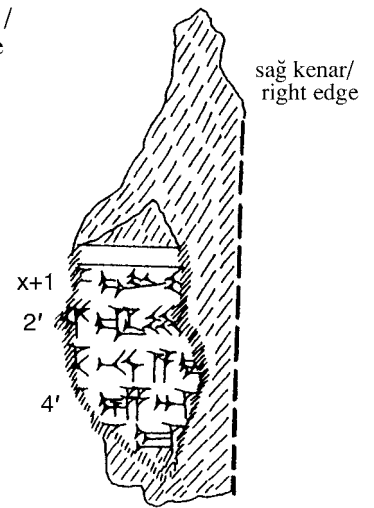
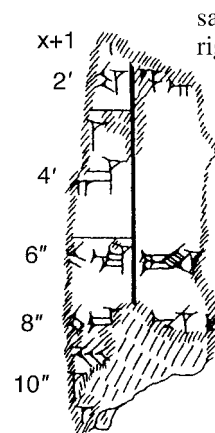

Text 349

AnAr 14947

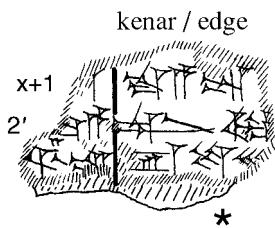

Text 350

AnAr 14954

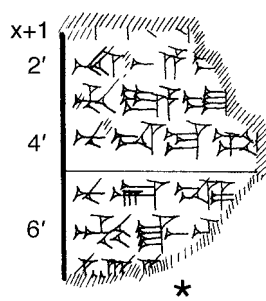

Text 351

AnAr 14957

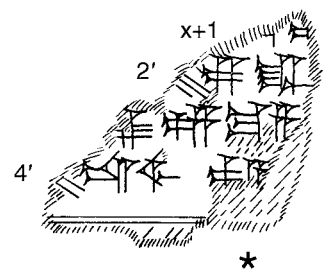

Text 352

AnAr 14964

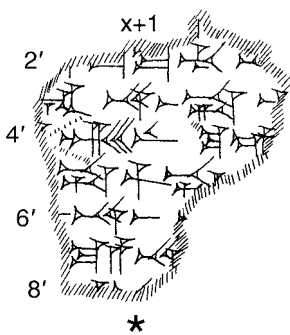

Text 353

AnAr 14968

önyüz / obverse

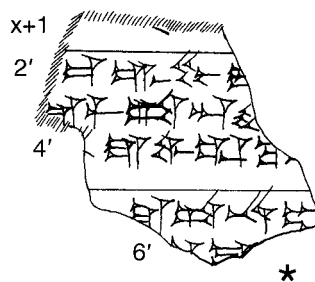

Text 354

AnAr 14969

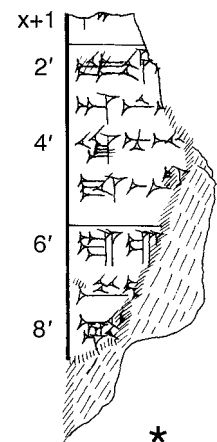

Text 355

AnAr 14974

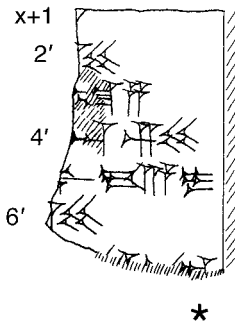

Text 356

AnAr 14975

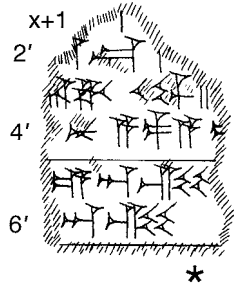

Text 357

AnAr 14978

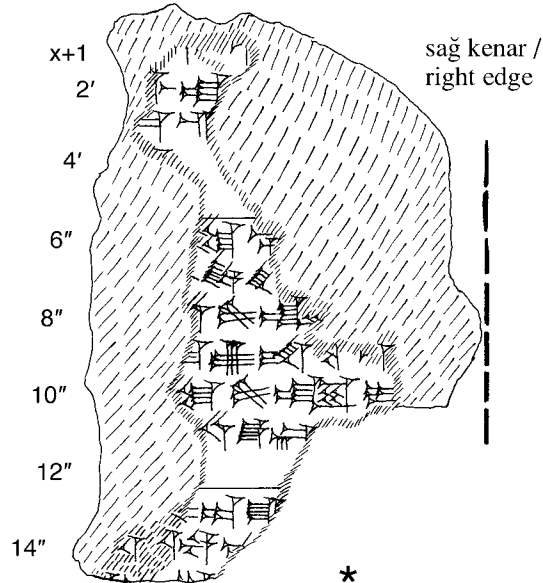

Text 358

AnAr 14981

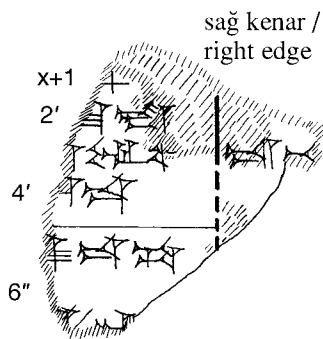

Text 359

AnAr 14982

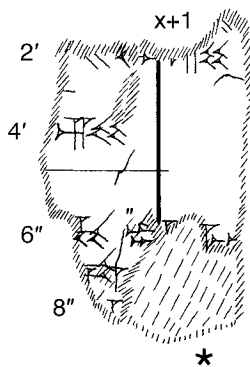

Text 360

AnAr 14983

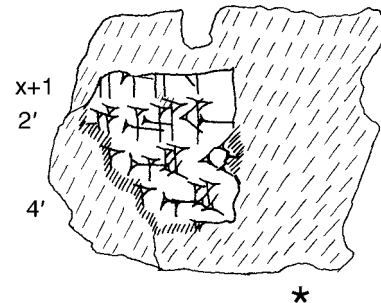

Text 361

AnAr 15154

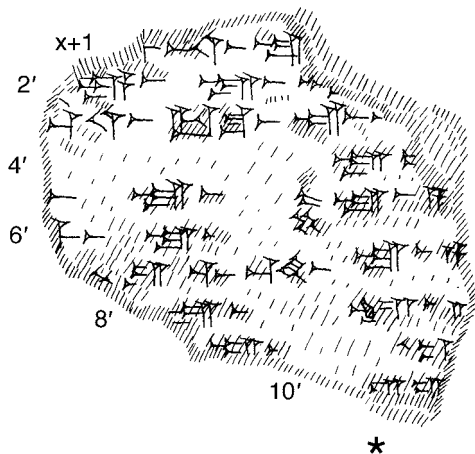

Text 362

AnAr 15156

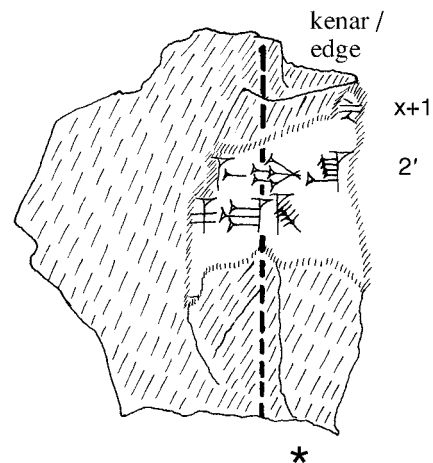

Text 363

AnAr 15159

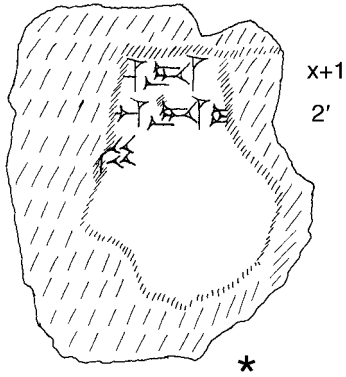

Text 364

AnAr 15161

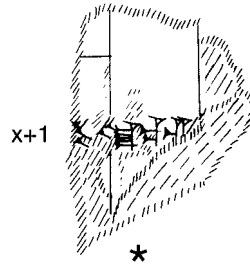

Text 365

AnAr 21624

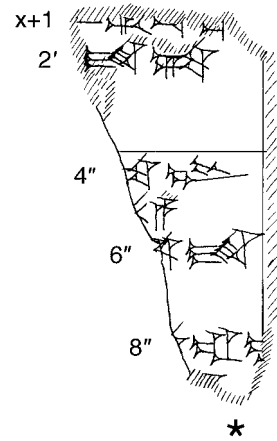

Text 366

AnAr 21625



Text 367

AnAr 21720

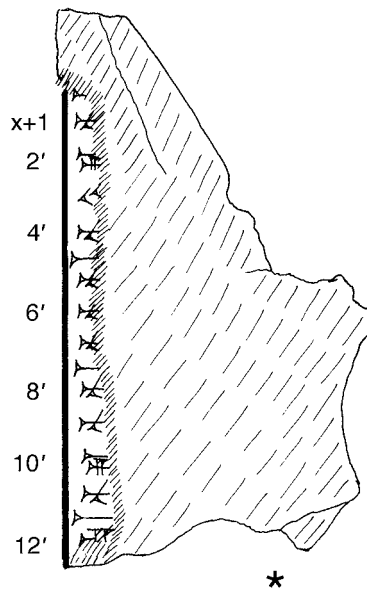

Text 368

AnAr 21721

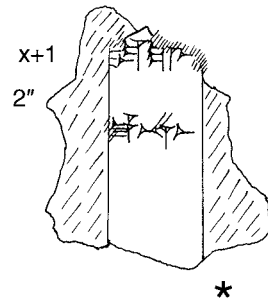

Text 369

AnAr 21731

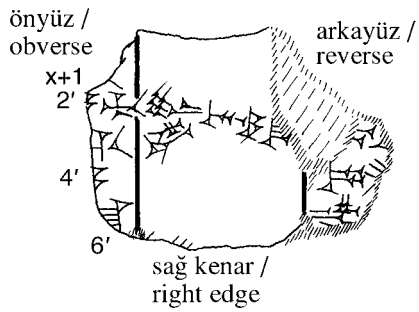

Text 370

AnAr 21733

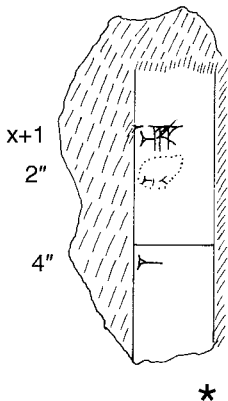

Text 371

AnAr 21740

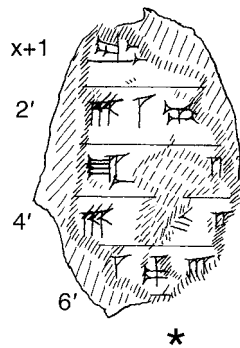

Text 372

AnAr 21766

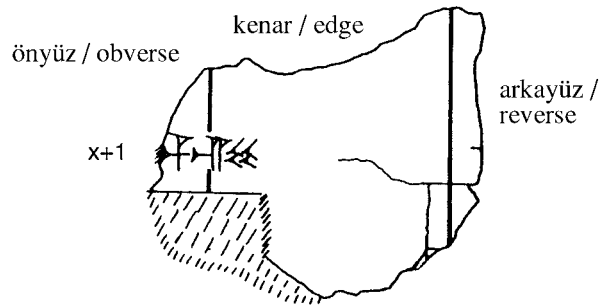

Text 373

AnAr 21771

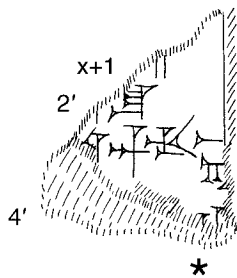

Text 374

AnAr 21829

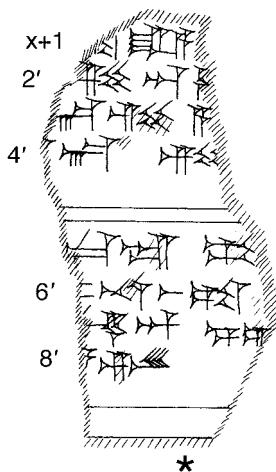

Text 375

AnAr 4220 b

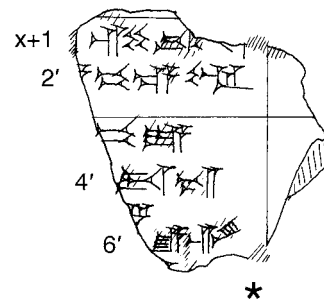

Text 378

AnAr 4220 k

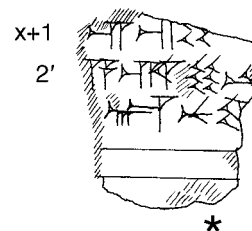

Text 376

AnAr 4220 c

önyüz / obverse

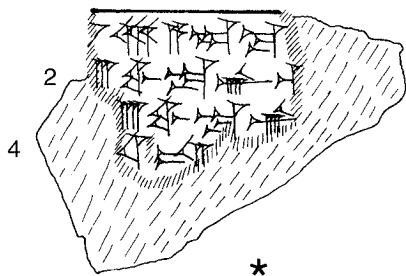

Text 377

AnAr 4220 h

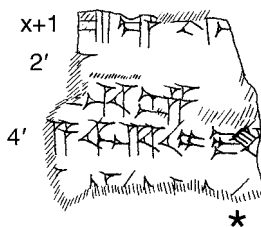

Text 379

AnAr 4220 ö

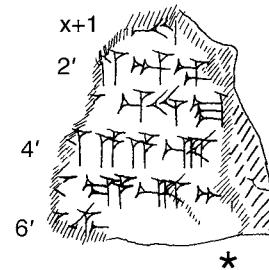

Text 380

AnAr 68-3-65

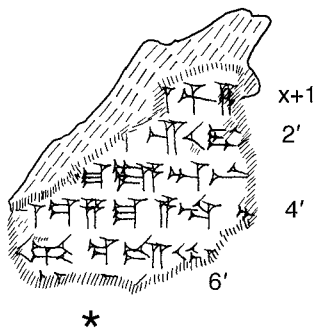

Text 381

AnAr 28-2-66

arkayüz? / reverse?

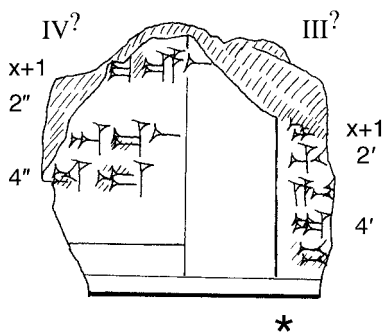

Text 382

AnAr 26-2-68

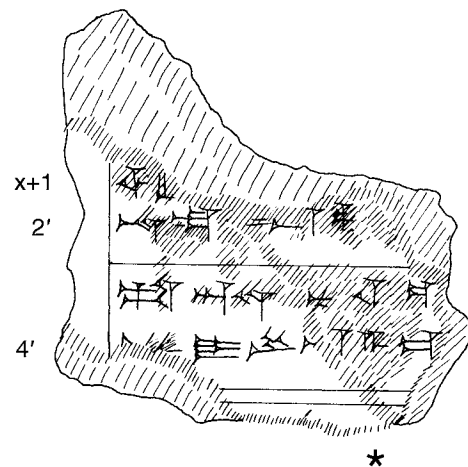

Text 383

AnAr 26-3-68

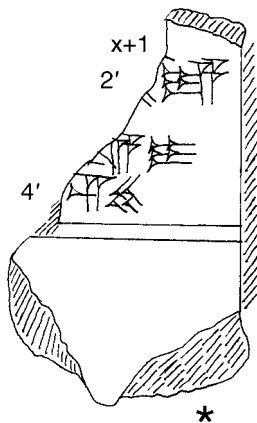

Text 384

AnAr 90-5-68

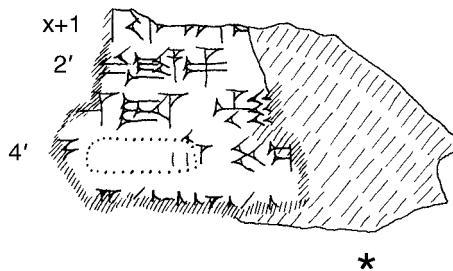

Text 385

AnAr 90-7-68

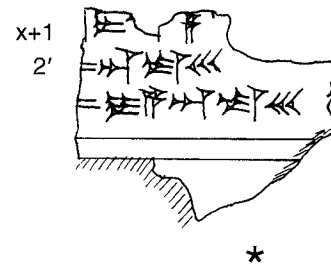

Text 386

AnAr 80-2-74

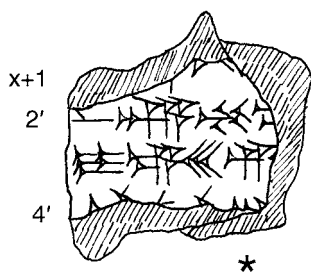

Text 387

AnAr 80-3-74

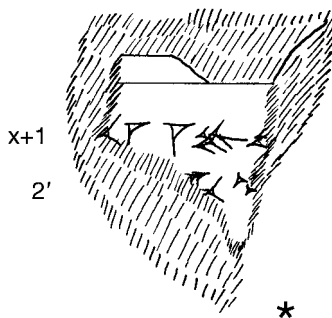

Text 388

AnAr 96-3-76

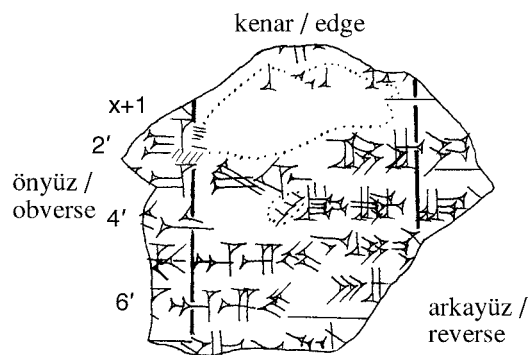

Text 389

AnAr 96-4-76

önyüz / obverse

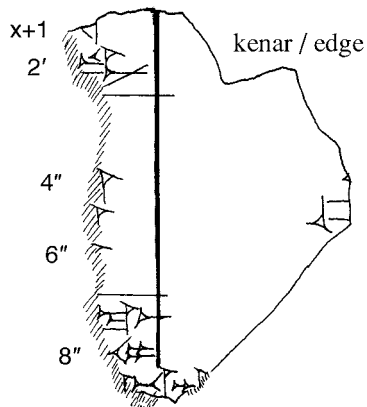

Text 390

AnAr 96-5-76

